



# STM6968

## Dual N-Channel Enhancement Mode Field Effect Transistor

PRODUCT SUMMARY		
V <sub>DSS</sub>	I <sub>D</sub>	R <sub>DS(ON)</sub> (mΩ) Max
60V	5A	60 @ V <sub>GS</sub> = 10V 70 @ V <sub>GS</sub> = 4.5V

### FEATURES

- Super high dense cell design for low R<sub>DS(ON)</sub>.
- Rugged and reliable.
- Surface Mount Package.
- ESD Protected.

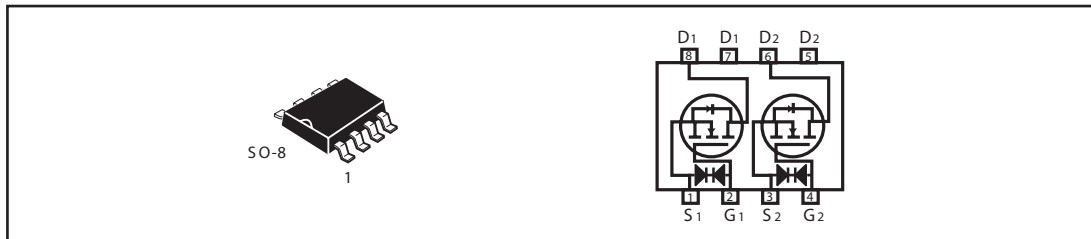

### ABSOLUTE MAXIMUM RATINGS (T<sub>A</sub>=25°C unless otherwise noted)

Parameter	Symbol	Limit	Unit	
Drain-Source Voltage	V <sub>DS</sub>	60	V	
Gate-Source Voltage	V <sub>GS</sub>	±20	V	
Drain Current-Continuous <sup>a</sup> @ T <sub>a</sub>	I <sub>D</sub>	25°C	5	A
		70°C	4.3	A
-Pulsed <sup>b</sup>	I <sub>DM</sub>	25	A	
Drain-Source Diode Forward Current <sup>a</sup>	I <sub>S</sub>	1.7	A	
Maximum Power Dissipation <sup>a</sup>	P <sub>D</sub>	T <sub>a</sub> =25°C	2	W
		T <sub>a</sub> =70°C	1.44	
Operating Junction and Storage Temperature Range	T <sub>J</sub> , T <sub>STG</sub>	-55 to 150	°C	

### THERMAL CHARACTERISTICS

Thermal Resistance, Junction-to-Ambient <sup>a</sup>	R <sub>θJA</sub>	62.5	°C/W
--	------------------	------	------

# STM6968

ELECTRICAL CHARACTERISTICS (T<sub>A</sub> 25°C unless otherwise noted)

Parameter	Symbol	Condition	Min	Typ <sup>c</sup>	Max	Unit
<b>OFF CHARACTERISTICS</b>						
Drain-Source Breakdown Voltage	BV <sub>DSS</sub>	V <sub>GS</sub> = 0V, I <sub>D</sub> = 250µA	60			V
Zero Gate Voltage Drain Current	I <sub>DSS</sub>	V <sub>DS</sub> = 48V, V <sub>GS</sub> = 0V			1	µA
Gate-Body Leakage	I <sub>GSS</sub>	V <sub>GS</sub> = ±20V, V <sub>DS</sub> = 0V			±10	µA
<b>ON CHARACTERISTICS<sup>b</sup></b>						
Gate Threshold Voltage	V <sub>GS(th)</sub>	V <sub>DS</sub> = V <sub>GS</sub> , I <sub>D</sub> = 250µA	1.0	1.7	3	V
Drain-Source On-State Resistance	R <sub>DS(ON)</sub>	V <sub>GS</sub> = 10V, I <sub>D</sub> = 4.5A		49	60	m ohm
		V <sub>GS</sub> = 4.5V, I <sub>D</sub> = 3A		55	70	m ohm
On-State Drain Current	I <sub>D(ON)</sub>	V <sub>DS</sub> = 5V, V <sub>GS</sub> = 10V	20			A
Forward Transconductance	g <sub>FS</sub>	V <sub>DS</sub> = 4.5V, I <sub>D</sub> = 4.5A		13		S
<b>DYNAMIC CHARACTERISTICS<sup>c</sup></b>						
Input Capacitance	C <sub>ISS</sub>	V <sub>DS</sub> = 25V, V <sub>GS</sub> = 0V f = 1.0MHz		685		pF
Output Capacitance	C <sub>OSS</sub>			85		pF
Reverse Transfer Capacitance	C <sub>RSS</sub>			50		pF
Gate resistance	R <sub>g</sub>	V <sub>GS</sub> = 0V, V <sub>DS</sub> = 0V, f = 1.0MHz		2		ohm
<b>SWITCHING CHARACTERISTICS<sup>c</sup></b>						
Turn-On Delay Time	t <sub>D(ON)</sub>	V <sub>DD</sub> = 30V I <sub>D</sub> = 4.5 A V <sub>GS</sub> = 10V R <sub>GEN</sub> = 6 ohm		11		ns
Rise Time	t <sub>r</sub>			12		ns
Turn-Off Delay Time	t <sub>D(OFF)</sub>			38		ns
Fall Time	t <sub>f</sub>			8		ns
Total Gate Charge	Q <sub>g</sub>	V <sub>DS</sub> = 48V, I <sub>D</sub> = 4.5A, V <sub>GS</sub> = 10V		12.7		nC
		V <sub>DS</sub> = 48V, I <sub>D</sub> = 4.5A, V <sub>GS</sub> = 4.5V		6.9		nC
Gate-Source Charge	Q <sub>gs</sub>	V <sub>DS</sub> = 48V, I <sub>D</sub> = 4.5 A		1.8		nC
Gate-Drain Charge	Q <sub>gd</sub>	V <sub>GS</sub> = 10V		3.6		nC

# STM6968

## ELECTRICAL CHARACTERISTICS ( $T_A=25^\circ\text{C}$ unless otherwise noted)

Parameter	Symbol	Condition	Min	Typ <sup>c</sup>	Max	Unit
<b>DRAIN-SOURCE DIODE CHARACTERISTICS<sup>b</sup></b>						
Diode Forward Voltage	$V_{SD}$	$V_{GS} = 0V, I_s = 1.7A$		0.8	1.2	V

### Notes

- a. Surface Mounted on FR4 Board,  $t \leq 10\text{sec}$ .
- b. Pulse Test: Pulse Width  $\leq 300\mu\text{s}$ , Duty Cycle  $\leq 2\%$ .
- c. Guaranteed by design, not subject to production testing.

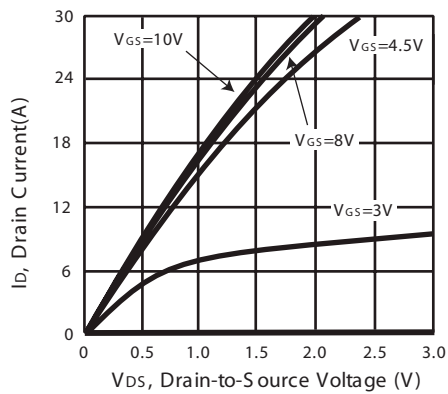

Figure 1. Output Characteristics

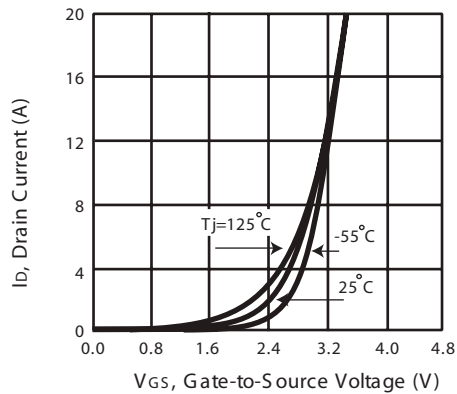

Figure 2. Transfer Characteristics

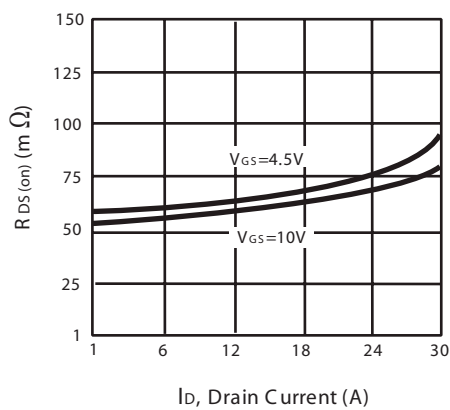

Figure 3. On-Resistance vs. Drain Current and Gate Voltage

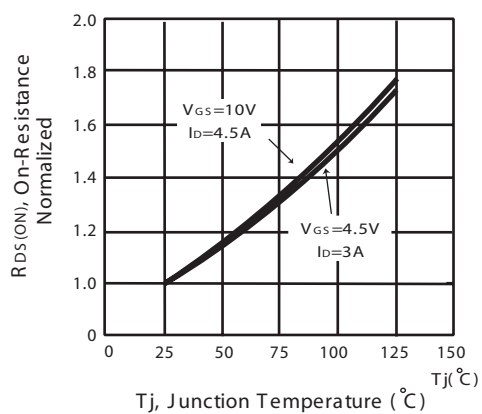

Figure 4. On-Resistance Variation with Drain Current and Temperature

# STM6968

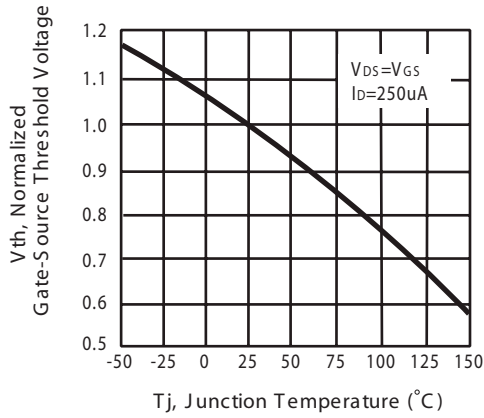

Figure 5. Gate Threshold Variation with Temperature

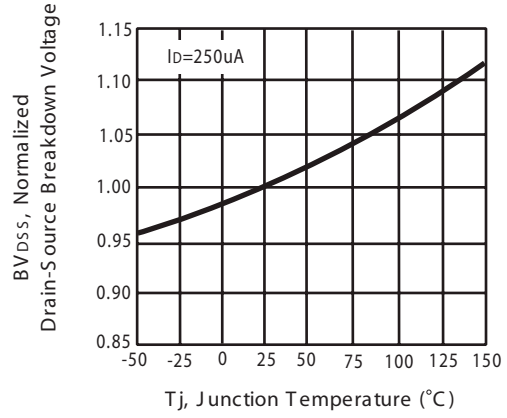

Figure 6. Breakdown Voltage Variation with Temperature

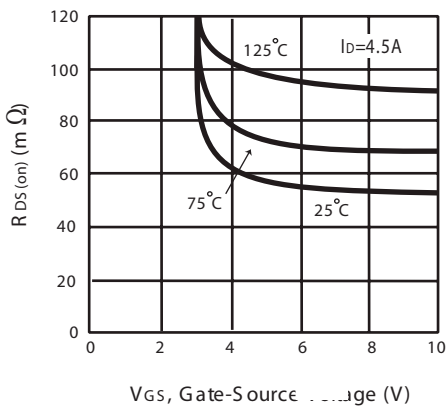

Figure 7. On-Resistance vs. Gate-Source Voltage

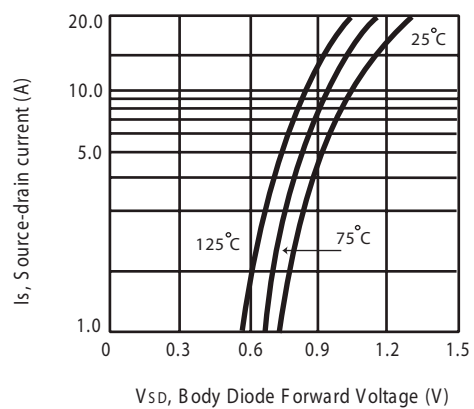

Figure 8. Body Diode Forward Voltage Variation with Source Current

# STM6968

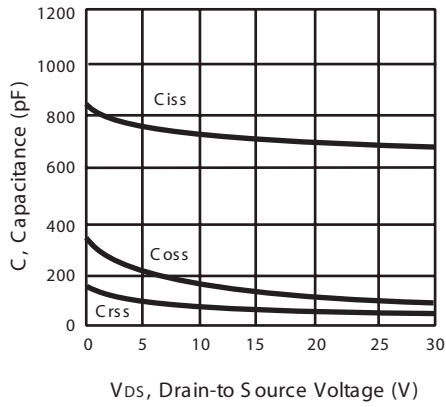

Figure 9. Capacitance

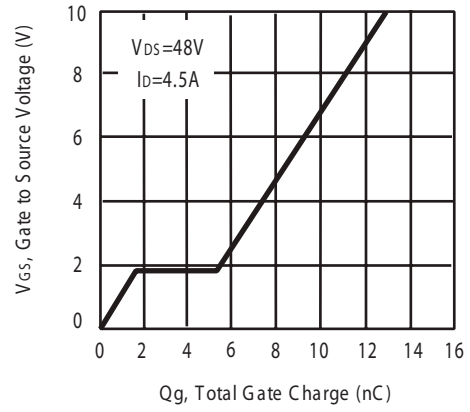

Figure 10. Gate Charge

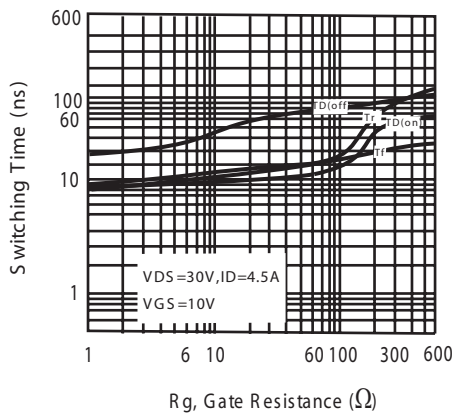

Figure 11. switching characteristics

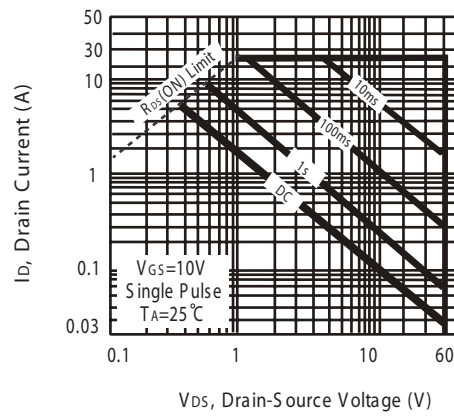
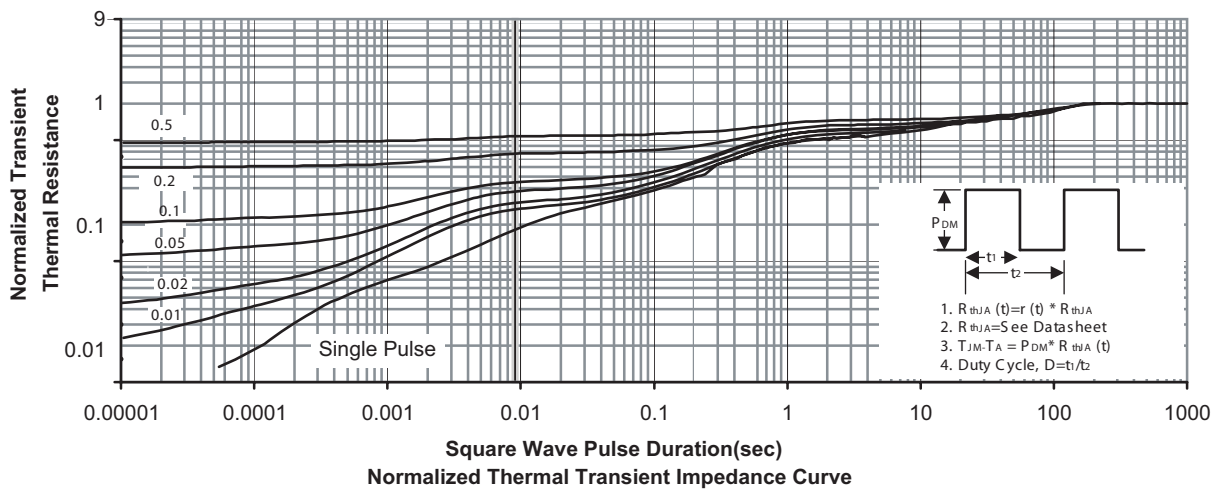

Figure 12. Maximum Safe Operating Area



# STM6968

## PACKAGE OUTLINE DIMENSIONS

SO-8

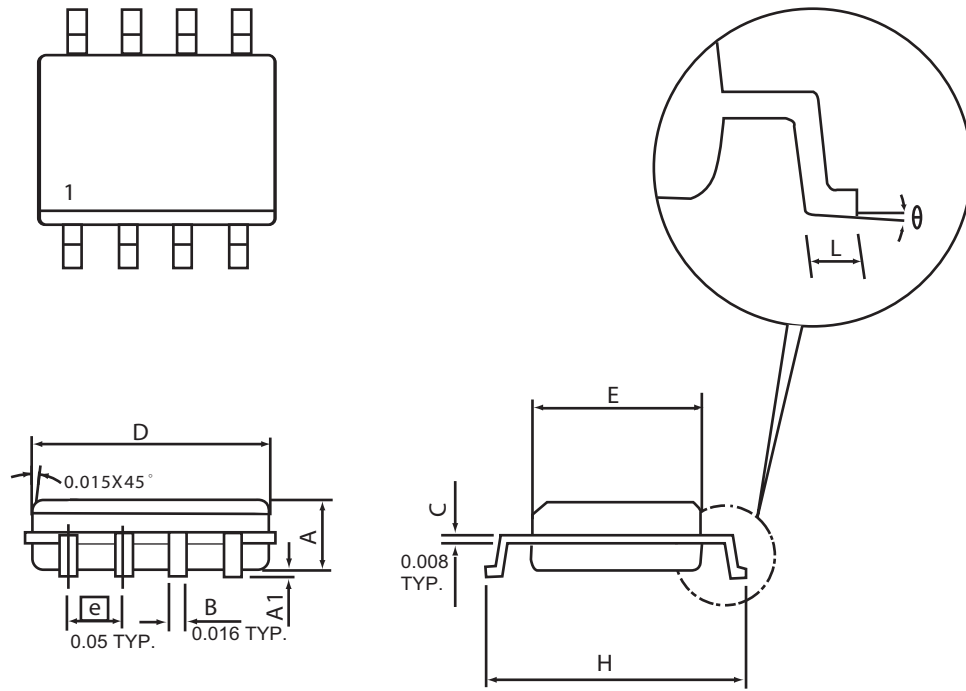

SYMBOLS	MILLIMETERS		INCHES	
	MIN	MAX	MIN	MAX
A	1.35	1.75	0.053	0.069
A1	0.10	0.25	0.004	0.010
D	4.80	4.98	0.189	0.196
E	3.81	3.99	0.150	0.157
H	5.79	6.20	0.228	0.244
L	0.41	1.27	0.016	0.050
$\theta$	0°	8°	0°	8°

# STM6968

## SO-8 Tape and Reel Data

### SO-8 Carrier Tape

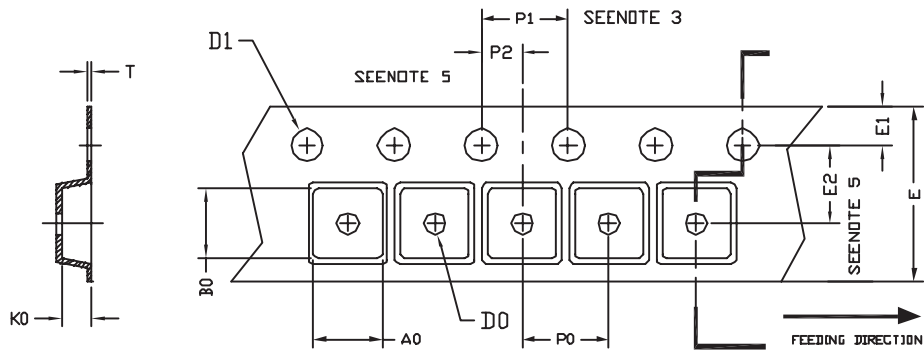

unit: mm

PACKAGE	A0	B0	K0	D0	D1	E	E1	E2	P0	P1	P2	T
SOP 8N 150mil	6.40	5.20	2.10	$\phi 1.5$ (MIN)	$\phi 1.5$ + 0.1 - 0.0	12.0 $\pm 0.3$	1.75	5.5 $\pm 0.05$	8.0	4.0	2.0 $\pm 0.05$	0.3 $\pm 0.05$

### SO-8 Reel

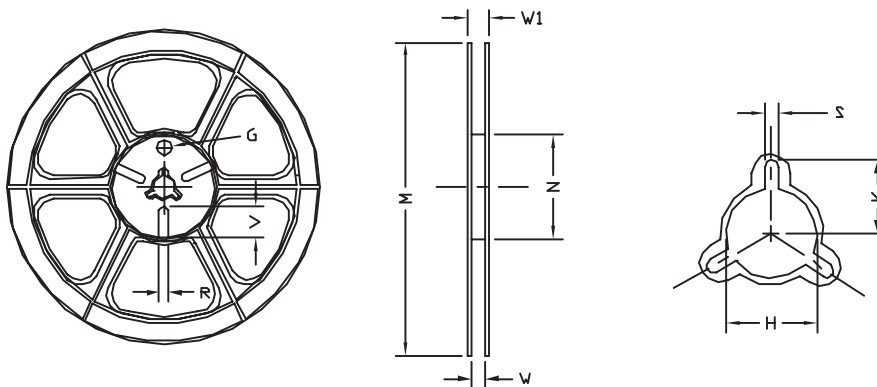

UNIT: mm

TAPE SIZE	REEL SIZE	M	N	W	W1	H	K	S	G	R	V
12 mm	$\phi 330$	330 $\pm 1$	62 $\pm 1.5$	12.4 + 0.2	16.8 - 0.4	$\phi 12.75$ + 0.15	---	2.0 $\pm 0.15$	---	---	---