

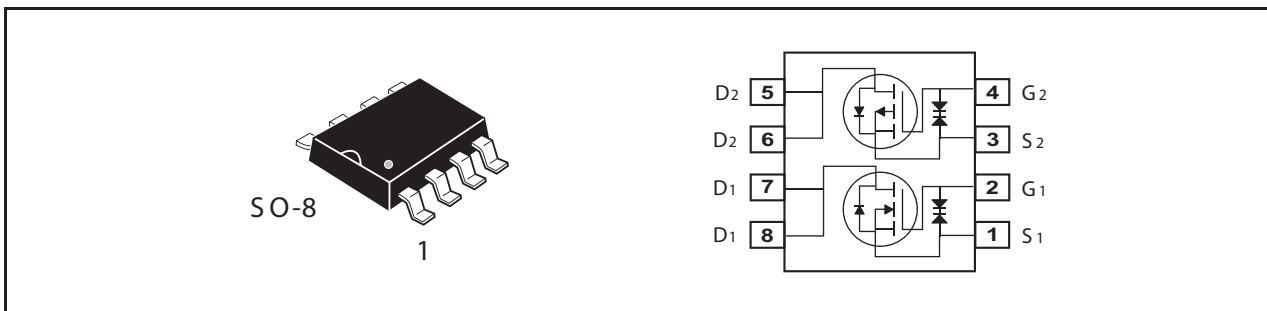

## Dual Enhancement Mode Field Effect Transistor ( N and P Channel )

PRODUCT SUMMARY (N-Channel)		
VDSS	ID	RDS(ON) (mΩ) Max
30V	7A	25 @ VGS=10V
		30 @ VGS=4.5V

PRODUCT SUMMARY (P-Channel)		
VDSS	ID	RDS(ON) (mΩ) Max
-30V	-6A	35 @ VGS=-10V
		52 @ VGS=-4.5V



### ABSOLUTE MAXIMUM RATINGS (TA=25°C unless otherwise noted)

Symbol	Parameter	N-Channel	P-Channel	Units	
V <sub>DS</sub>	Drain-Source Voltage	30	-30	V	
V <sub>GS</sub>	Gate-Source Voltage	±20	±20	V	
I <sub>D</sub>	Drain Current-Continuous <sup>a</sup>	T <sub>A</sub> =25°C	7	-6	A
		T <sub>A</sub> =70°C	5.6	-4.8	A
I <sub>DM</sub>	-Pulsed <sup>b</sup>	25	-22	A	
E <sub>AS</sub>	Single Pulse Avalanche Energy <sup>d</sup>	17	20	mJ	
P <sub>D</sub>	Maximum Power Dissipation <sup>a</sup>	T <sub>A</sub> =25°C	2	W	
		T <sub>A</sub> =70°C	1.3		
T <sub>J</sub> , T <sub>STG</sub>	Operating Junction and Storage Temperature Range	-55 to 150		°C	

### THERMAL CHARACTERISTICS

R <sub>θJA</sub>	Thermal Resistance, Junction-to-Ambient <sup>a</sup>	62.5	°C/W
------------------	--	------	------

**N-Channel ELECTRICAL CHARACTERISTICS (TA=25°C unless otherwise noted)**

Symbol	Parameter	Conditions	Min	Typ	Max	Units
<b>OFF CHARACTERISTICS</b>						
BV <sub>DSS</sub>	Drain-Source Breakdown Voltage	V <sub>GS</sub> =0V, I <sub>D</sub> =250μA	30			V
I <sub>DSS</sub>	Zero Gate Voltage Drain Current	V <sub>DS</sub> =24V, V <sub>GS</sub> =0V			1	μA
I <sub>GSS</sub>	Gate-Body Leakage Current	V <sub>GS</sub> = ±20V, V <sub>DS</sub> =0V			±10	μA
<b>ON CHARACTERISTICS</b>						
V <sub>GS(th)</sub>	Gate Threshold Voltage	V <sub>DS</sub> =V <sub>GS</sub> , I <sub>D</sub> =250μA	1	1.7	3	V
R <sub>DS(ON)</sub>	Drain-Source On-State Resistance	V <sub>GS</sub> =10V, I <sub>D</sub> =7A		19	25	m ohm
		V <sub>GS</sub> =4.5V, I <sub>D</sub> =6.4A		24	30	m ohm
g <sub>FS</sub>	Forward Transconductance	V <sub>DS</sub> =5V, I <sub>D</sub> =7A		13		S
<b>DYNAMIC CHARACTERISTICS <sup>c</sup></b>						
C <sub>ISS</sub>	Input Capacitance	V <sub>DS</sub> =15V, V <sub>GS</sub> =0V f=1.0MHz		445		pF
C <sub>OSS</sub>	Output Capacitance			120		pF
C <sub>RSS</sub>	Reverse Transfer Capacitance			60		pF
<b>SWITCHING CHARACTERISTICS <sup>c</sup></b>						
t <sub>D(ON)</sub>	Turn-On Delay Time	V <sub>DD</sub> =15V I <sub>D</sub> =1A		8.5		ns
t <sub>r</sub>	Rise Time			10.5		ns
t <sub>D(OFF)</sub>	Turn-Off Delay Time	V <sub>GS</sub> =10V R <sub>GEN</sub> =6 ohm		17		ns
t <sub>f</sub>	Fall Time			20		ns
Q <sub>g</sub>	Total Gate Charge	V <sub>DS</sub> =15V, I <sub>D</sub> =7A, V <sub>GS</sub> =10V		8		nC
		V <sub>DS</sub> =15V, I <sub>D</sub> =7A, V <sub>GS</sub> =4.5V		4		nC
Q <sub>gs</sub>	Gate-Source Charge	V <sub>DS</sub> =15V, I <sub>D</sub> =7A, V <sub>GS</sub> =10V		1.3		nC
Q <sub>gd</sub>	Gate-Drain Charge			1.8		nC
<b>DRAIN-SOURCE DIODE CHARACTERISTICS</b>						
I <sub>S</sub>	Maximum Continuous Drain-Source Diode Forward Current				1.7	A
V <sub>SD</sub>	Diode Forward Voltage <sup>b</sup>	V <sub>GS</sub> =0V, I <sub>S</sub> =1.7A		0.78	1.2	V

## P-Channel ELECTRICAL CHARACTERISTICS (T<sub>A</sub>=25°C unless otherwise noted)

Symbol	Parameter	Conditions	Min	Typ	Max	Units
<b>OFF CHARACTERISTICS</b>						
BV <sub>DSS</sub>	Drain-Source Breakdown Voltage	V <sub>GS</sub> =0V, I <sub>D</sub> =-250μA	-30			V
I <sub>DSS</sub>	Zero Gate Voltage Drain Current	V <sub>DS</sub> =-24V, V <sub>GS</sub> =0V			-1	μA
I <sub>GSS</sub>	Gate-Body Leakage Current	V <sub>GS</sub> = ±20V, V <sub>DS</sub> =0V			±10	μA
<b>ON CHARACTERISTICS</b>						
V <sub>GS(th)</sub>	Gate Threshold Voltage	V <sub>DS</sub> =V <sub>GS</sub> , I <sub>D</sub> =-250μA	-1.0	-1.6	-3.0	V
R <sub>DS(ON)</sub>	Drain-Source On-State Resistance	V <sub>GS</sub> =-10V, I <sub>D</sub> =-6A		27	35	m ohm
		V <sub>GS</sub> =-4.5V, I <sub>D</sub> =-4.9A		38	52	m ohm
g <sub>FS</sub>	Forward Transconductance	V <sub>DS</sub> =-5V, I <sub>D</sub> =-6A		8.5		S
<b>DYNAMIC CHARACTERISTICS °</b>						
C <sub>ISS</sub>	Input Capacitance	V <sub>DS</sub> =-15V, V <sub>GS</sub> =0V f=1.0MHz		790		pF
C <sub>OSS</sub>	Output Capacitance			215		pF
C <sub>RSS</sub>	Reverse Transfer Capacitance			120		pF
<b>SWITCHING CHARACTERISTICS °</b>						
t <sub>D(ON)</sub>	Turn-On Delay Time	V <sub>DD</sub> =-15V I <sub>D</sub> =-1A		10		ns
t <sub>r</sub>	Rise Time			15		ns
t <sub>D(OFF)</sub>	Turn-Off Delay Time	V <sub>GS</sub> =-10V R <sub>GEN</sub> =6 ohm		67		ns
t <sub>f</sub>	Fall Time			33		ns
Q <sub>g</sub>	Total Gate Charge	V <sub>DS</sub> =-15V, I <sub>D</sub> =-6A, V <sub>GS</sub> =-10V		15		nC
		V <sub>DS</sub> =-15V, I <sub>D</sub> =-6A, V <sub>GS</sub> =-4.5V		7.5		nC
Q <sub>gs</sub>	Gate-Source Charge	V <sub>DS</sub> =-15V, I <sub>D</sub> =-6A,		1.4		nC
Q <sub>gd</sub>	Gate-Drain Charge	V <sub>GS</sub> =-10V		4		nC
<b>DRAIN-SOURCE DIODE CHARACTERISTICS</b>						
I <sub>S</sub>	Maximum Continuous Drain-Source Diode Forward Current				-1.7	A
V <sub>SD</sub>	Diode Forward Voltage <sup>b</sup>	V <sub>GS</sub> =0V, I <sub>S</sub> =-1.7A		-0.76	-1.2	V
<b>Notes</b> a. Surface Mounted on FR4 Board, t ≤ 10sec. b. Pulse Test: Pulse Width ≤ 300us, Duty Cycle ≤ 2%. c. Guaranteed by design, not subject to production testing. d. Starting T <sub>J</sub> =25°C, V <sub>DD</sub> = 20V, V <sub>GS</sub> =10V, L=0.5mH.						

## N-Channel

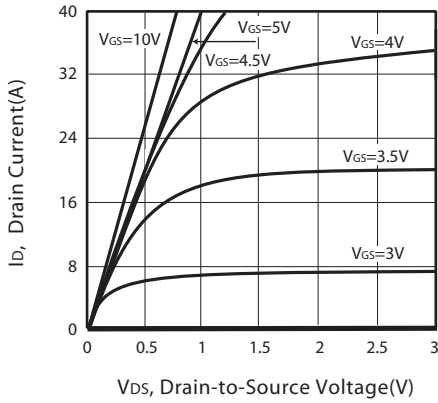

Figure 1. Output Characteristics

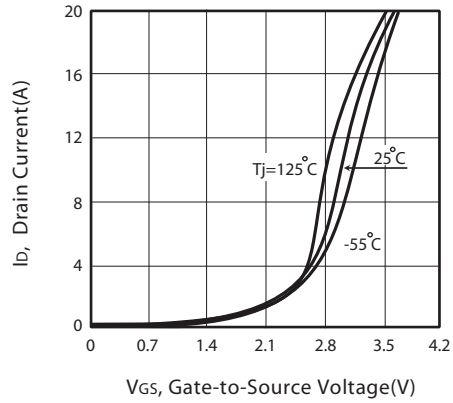

Figure 2. Transfer Characteristics

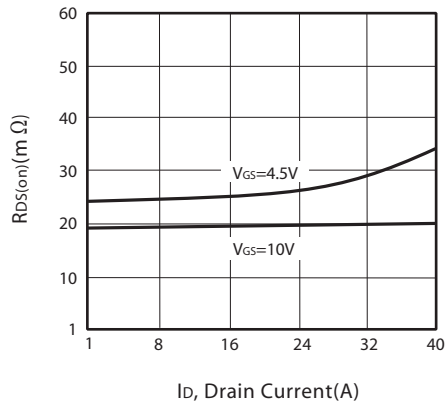

Figure 3. On-Resistance vs. Drain Current and Gate Voltage

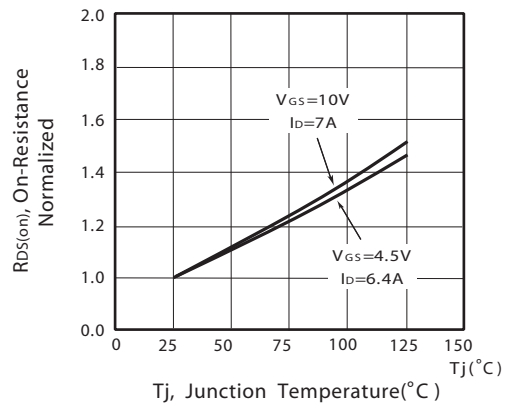

Figure 4. On-Resistance Variation with Drain Current and Temperature

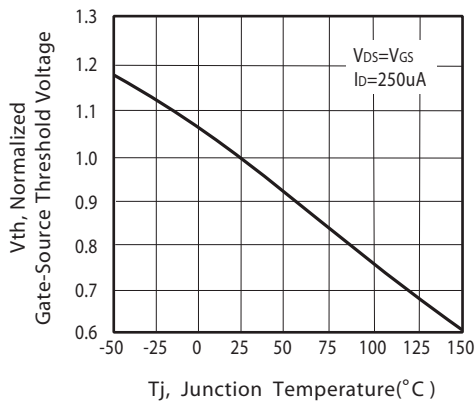

Figure 5. Gate Threshold Variation with Temperature

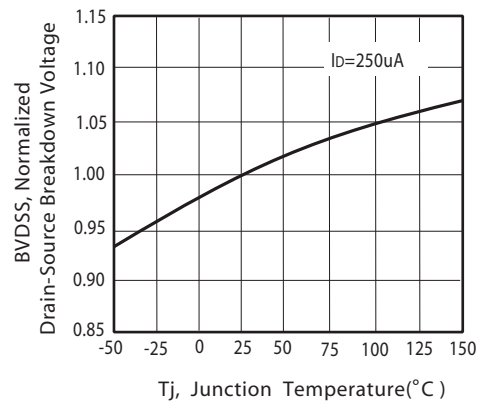

Figure 6. Breakdown Voltage Variation with Temperature

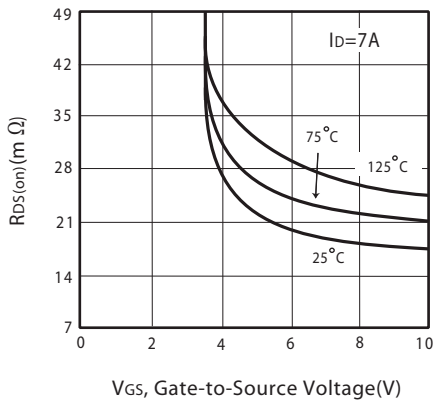

Figure 7. On-Resistance vs. Gate-Source Voltage

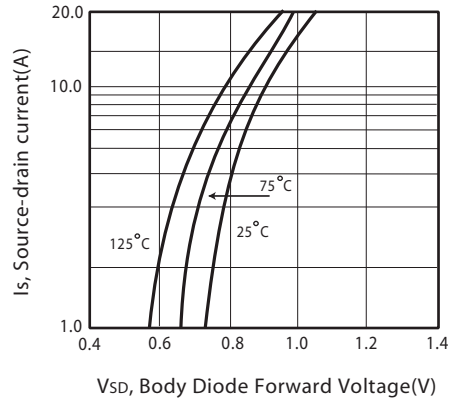

Figure 8. Body Diode Forward Voltage Variation with Source Current

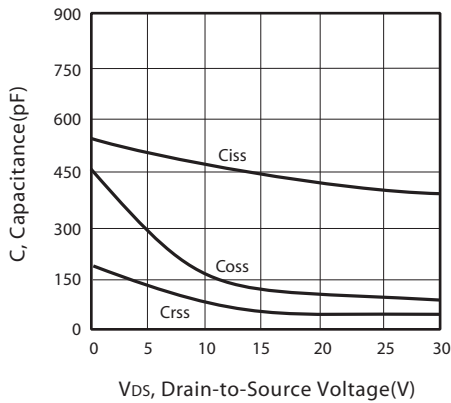

Figure 9. Capacitance

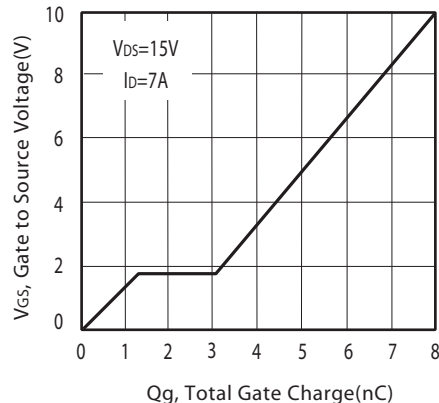

Figure 10. Gate Charge

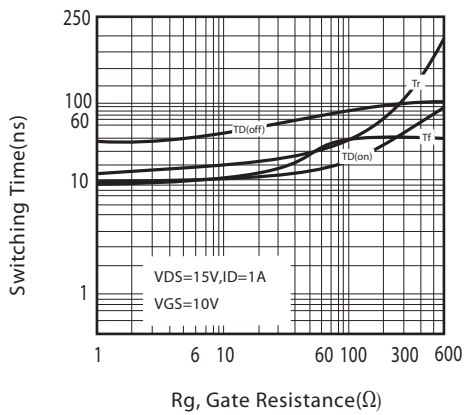

Figure 11. switching characteristics

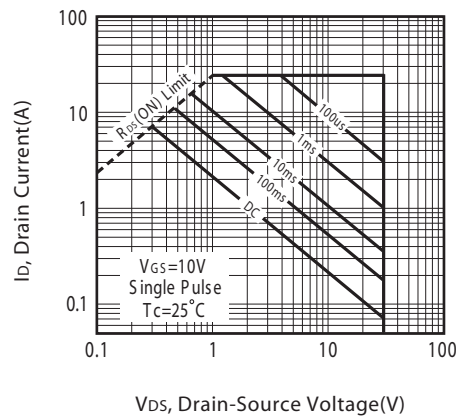
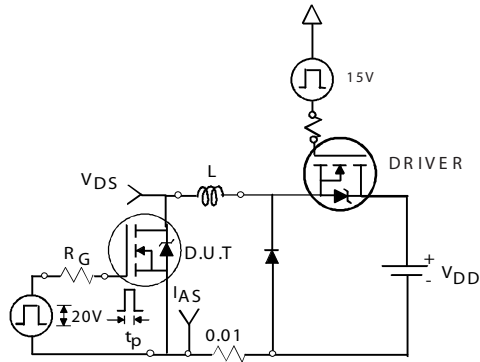
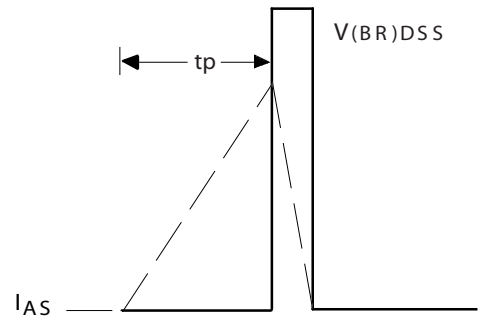

Figure 12. Maximum Safe Operating Area



Unclamped Inductive Test Circuit

Figure 13a.



Unclamped Inductive Waveforms

Figure 13b.

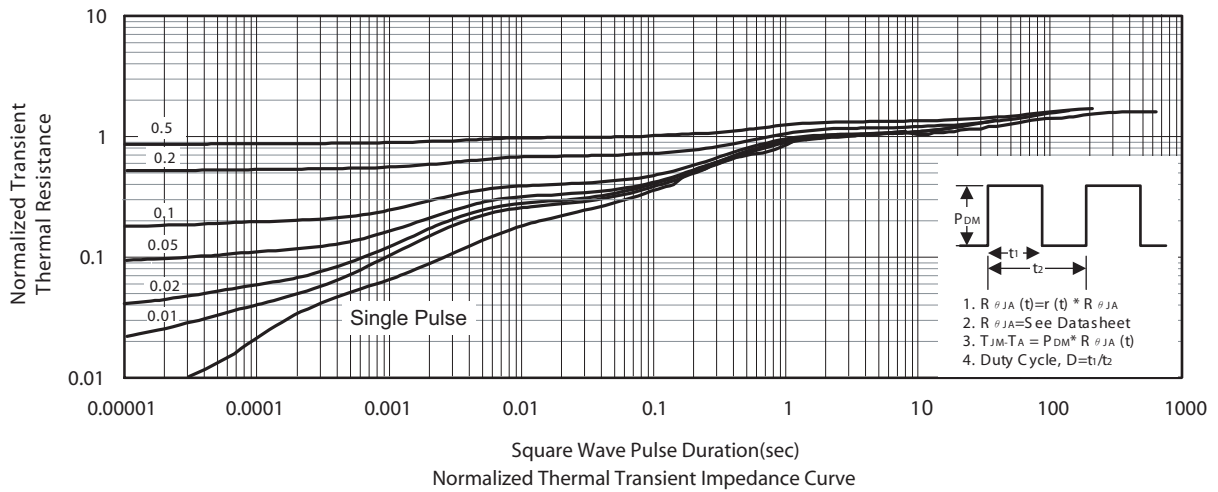

P-Channel

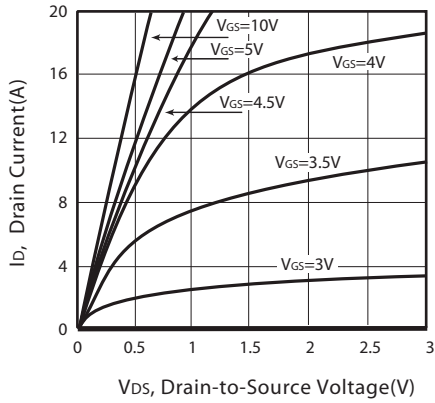

Figure 1. Output Characteristics

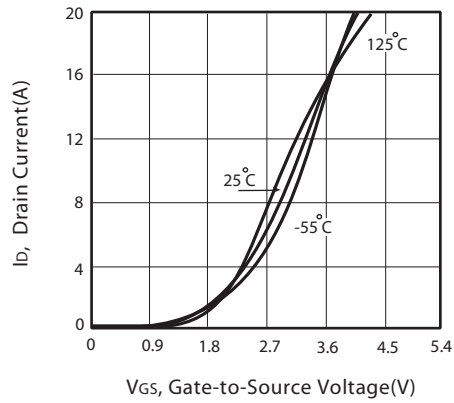

Figure 2. Transfer Characteristics

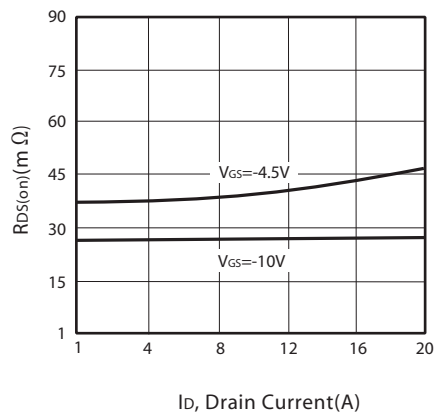

Figure 3. On-Resistance vs. Drain Current and Gate Voltage

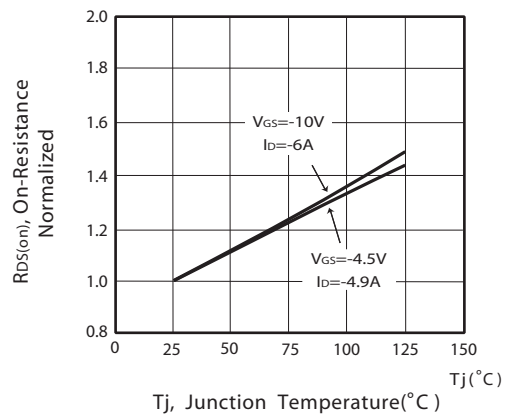

Figure 4. On-Resistance Variation with Drain Current and Temperature

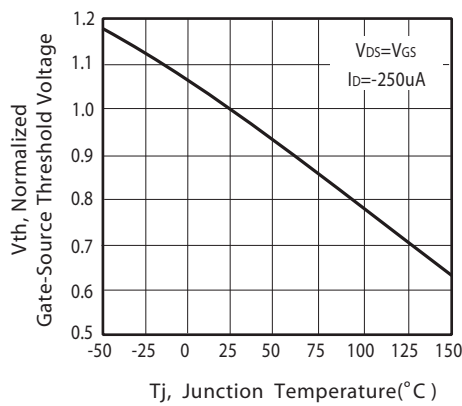

Figure 5. Gate Threshold Variation with Temperature

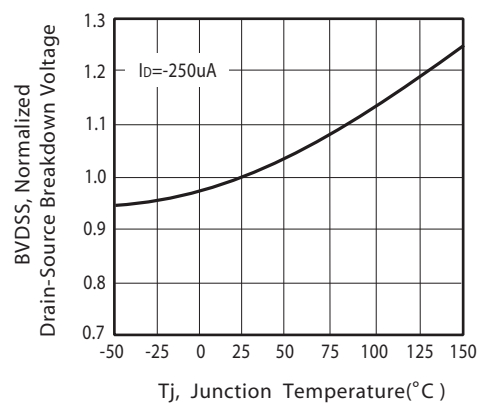

Figure 6. Breakdown Voltage Variation with Temperature

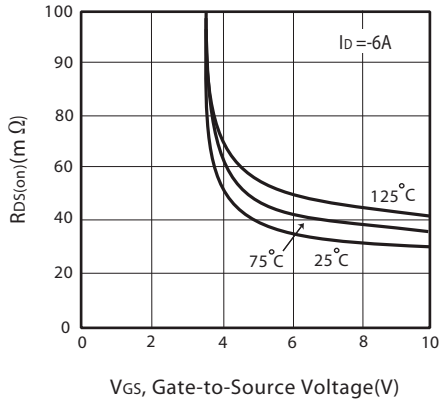

Figure 7. On-Resistance vs. Gate-Source Voltage

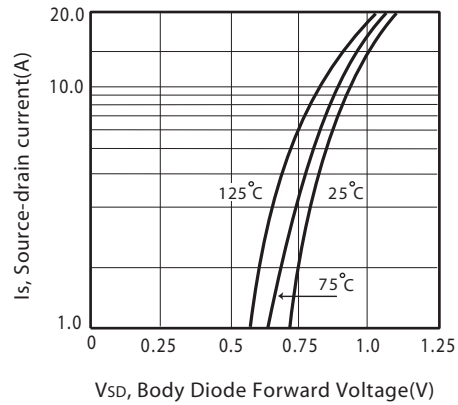

Figure 8. Body Diode Forward Voltage Variation with Source Current

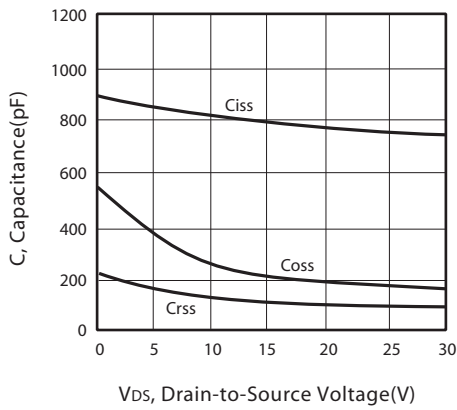

Figure 9. Capacitance

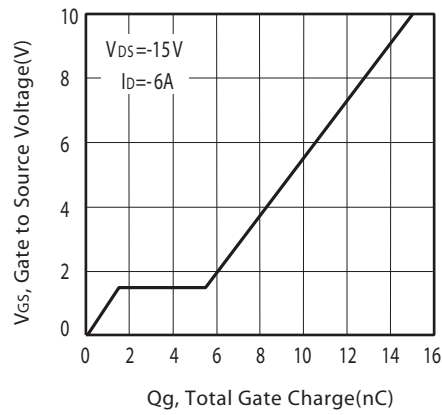

Figure 10. Gate Charge

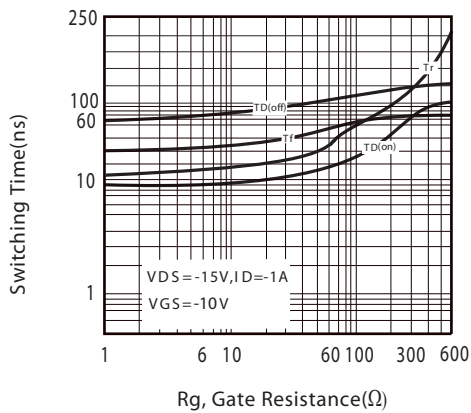

Figure 11. switching characteristics

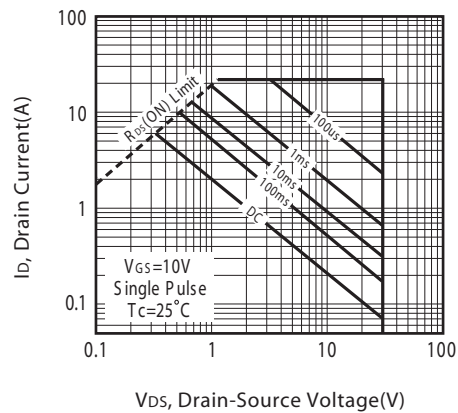
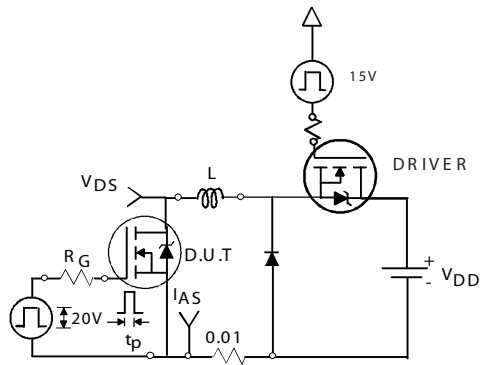

Figure 12. Maximum Safe Operating Area





Unclamped Inductive Test Circuit

Figure 13a.

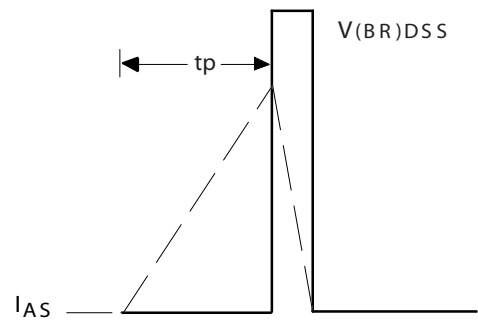

Unclamped Inductive Waveforms

Figure 13b.

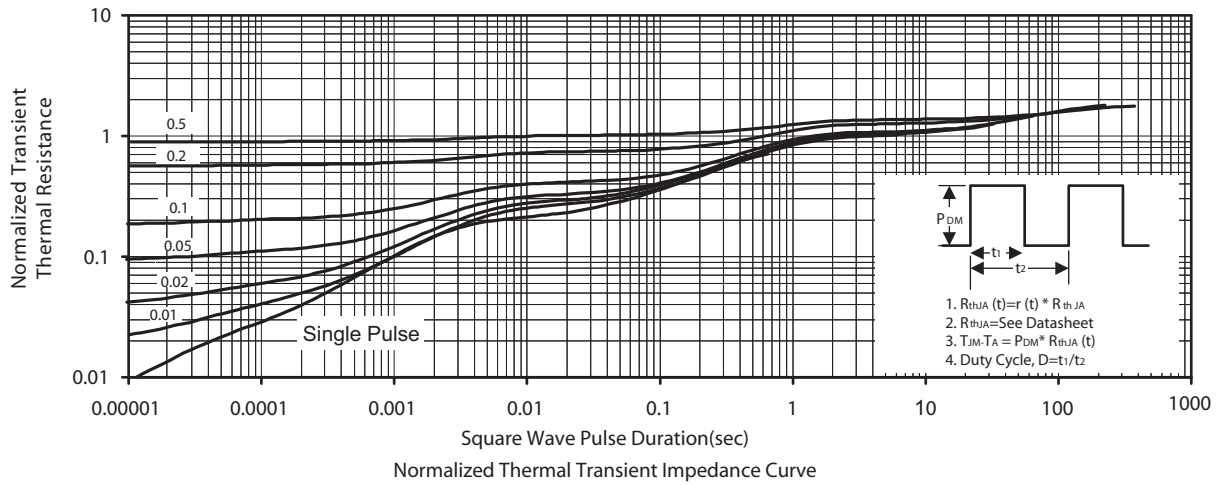

## PACKAGE OUTLINE DIMENSIONS

SO-8

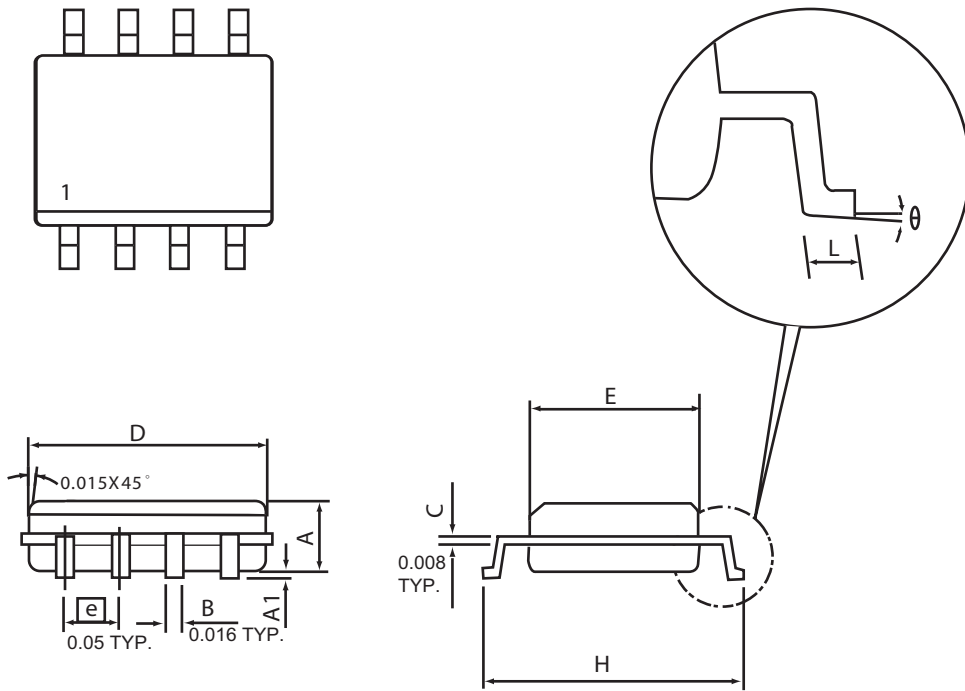

SYMBOLS	MILLIMETERS		INCHES	
	MIN	MAX	MIN	MAX
A	1.35	1.75	0.053	0.069
A1	0.10	0.25	0.004	0.010
D	4.80	4.98	0.189	0.196
E	3.81	3.99	0.150	0.157
H	5.79	6.20	0.228	0.244
L	0.41	1.27	0.016	0.050
$\theta$	0°	8°	0°	8°

## SO-8 Tape and Reel Data

### SO-8 Carrier Tape

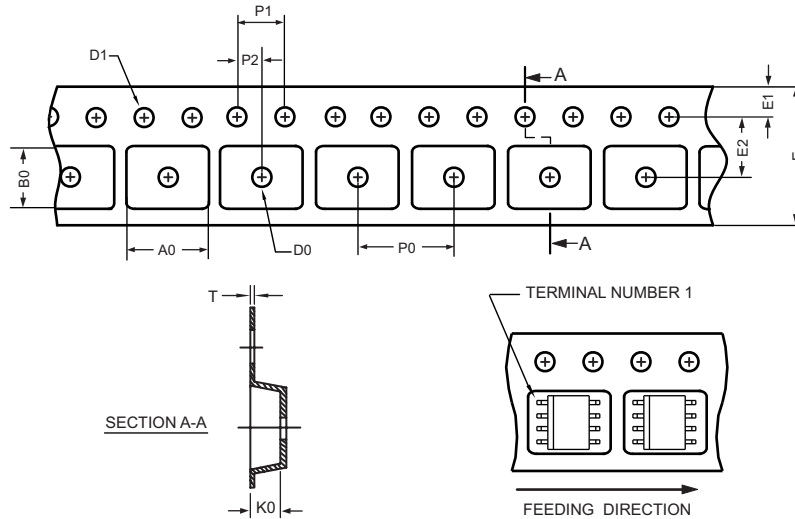

unit:mm

PACKAGE	A0	B0	K0	D0	D1	E	E1	E2	P0	P1	P2	T
SOP 8N 150mil	6.50 ±0.15	5.25 ±0.10	2.10 ±0.10	φ 1.5 (MIN)	φ 1.55 ±0.10	12.0 +0.3 -0.1	1.75 ±0.10	5.5 ±0.10	8.0 ±0.10	4.0 ±0.10	2.0 ±0.10	0.30 ±0.013

### SO-8 Reel

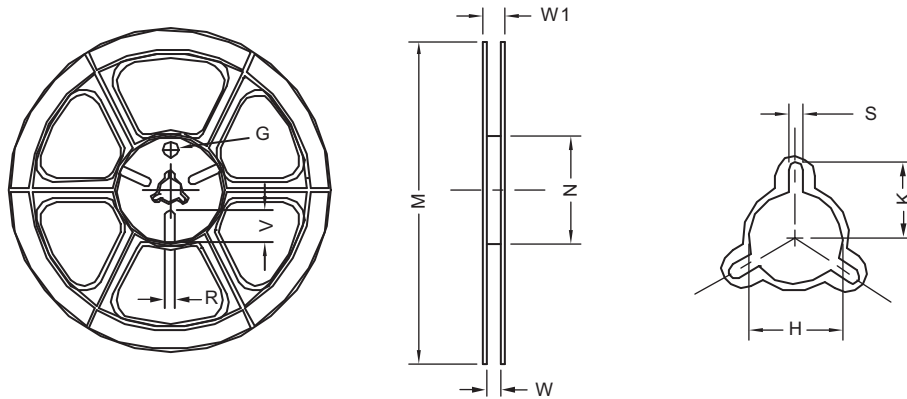

UNIT:mm

TAPE SIZE	REEL SIZE	M	N	W	W1	H	K	S	G	R	V
12 mm	φ 330	330 ± 1	62 ±1.5	12.4 +0.2	16.8 - 0.4	φ 12.75 + 0.15	---	2.0 ±0.15	---	---	---