

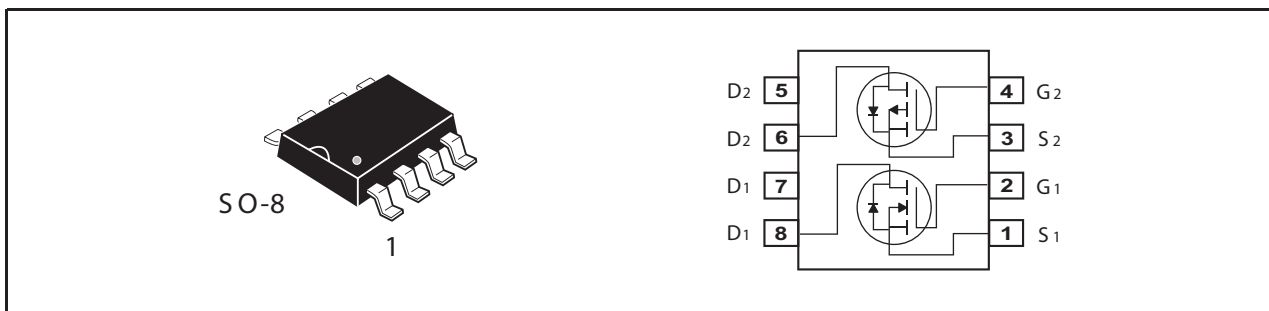

Dual Enhancement Mode Field Effect Transistor (N and P Channel)

PRODUCT SUMMARY (N-Channel)		
VDSS	ID	RDS(ON) (mΩ) Max
40V	6.6A	29 @ VGS=10V
		45 @ VGS=4.5V

PRODUCT SUMMARY (P-Channel)		
VDSS	ID	RDS(ON) (mΩ) Max
-40V	-5.8A	38 @ VGS=-10V
		60 @ VGS=-4.5V



ABSOLUTE MAXIMUM RATINGS (T_C=25°C unless otherwise noted)

Symbol	Parameter	N-Channel	P-Channel	Units	
V _{DS}	Drain-Source Voltage	40	-40	V	
V _{GS}	Gate-Source Voltage	±20	±20	V	
I _D	Drain Current-Continuous ^a	T _C =25°C	6.6	-5.8	A
		T _C =70°C	5.3	-4.6	A
I _{DM}	-Pulsed ^b	24	-21	A	
E _{AS}	Single Pulse Avalanche Energy ^d	36	30	mJ	
P _D	Maximum Power Dissipation ^a	T _C =25°C	2	W	
		T _C =70°C	1.28	W	
T _J , T _{STG}	Operating Junction and Storage Temperature Range	-55 to 150		°C	

THERMAL CHARACTERISTICS

R _{θJA}	Thermal Resistance, Junction-to-Ambient ^a	62.5	°C/W
------------------	--	------	------

STM8362

Ver 1.1

N-Channel ELECTRICAL CHARACTERISTICS (T_C=25°C unless otherwise noted)

Symbol	Parameter	Conditions	Min	Typ	Max	Units
OFF CHARACTERISTICS						
BV _{DSS}	Drain-Source Breakdown Voltage	V _{GS} =0V , I _D =250uA	40			V
I _{DSS}	Zero Gate Voltage Drain Current	V _{DS} =32V , V _{GS} =0V			1	uA
I _{GSS}	Gate-Body Leakage Current	V _{GS} = ±20V , V _{DS} =0V			±100	nA
ON CHARACTERISTICS						
V _{GS(th)}	Gate Threshold Voltage	V _{DS} =V _{GS} , I _D =250uA	1.4	1.8	3	V
R _{DS(ON)}	Drain-Source On-State Resistance	V _{GS} =10V , I _D =6.6A		23	29	m ohm
		V _{GS} =4.5V , I _D =5.3A		33	45	m ohm
g _{FS}	Forward Transconductance	V _{DS} =5V , I _D =6.6A		18		S
DYNAMIC CHARACTERISTICS ^c						
C _{ISS}	Input Capacitance	V _{DS} =20V, V _{GS} =0V f=1.0MHz		755		pF
C _{OSS}	Output Capacitance			81		pF
C _{RSS}	Reverse Transfer Capacitance			67		pF
SWITCHING CHARACTERISTICS ^c						
t _{D(ON)}	Turn-On Delay Time	V _{DD} =20V I _D =1A V _{GS} =10V R _{GEN} = 6 ohm		12		ns
t _r	Rise Time			14		ns
t _{D(OFF)}	Turn-Off Delay Time			18		ns
t _f	Fall Time			20		ns
Q _g	Total Gate Charge	V _{DS} =20V, I _D =6.6A, V _{GS} =10V		15		nC
		V _{DS} =20V, I _D =6.6A, V _{GS} =4.5V		7.4		nC
Q _{gs}	Gate-Source Charge	V _{DS} =20V, I _D =6.6A,		1.9		nC
Q _{gd}	Gate-Drain Charge	V _{GS} =10V		4.1		nC
DRAIN-SOURCE DIODE CHARACTERISTICS AND MAXIMUM RATINGS						
I _S	Maximum Continuous Drain-Source Diode Forward Current				2.0	A
V _{SD}	Diode Forward Voltage ^b	V _{GS} =0V, I _S =2.0A		0.82	1.3	V

Nov,12,2009

P-Channel ELECTRICAL CHARACTERISTICS (T_C=25°C unless otherwise noted)

Symbol	Parameter	Conditions	Min	Typ	Max	Units
OFF CHARACTERISTICS						
BV _{DSS}	Drain-Source Breakdown Voltage	V _{GS} =0V , I _D =-250uA	-40			V
I _{DSS}	Zero Gate Voltage Drain Current	V _{DS} =-32V , V _{GS} =0V			-1	uA
I _{GSS}	Gate-Body Leakage Current	V _{GS} = ±20V , V _{DS} =0V			±100	nA
ON CHARACTERISTICS						
V _{GS(th)}	Gate Threshold Voltage	V _{DS} =V _{GS} , I _D =-250uA	-1.4	-2.0	-3	V
R _{DS(ON)}	Drain-Source On-State Resistance	V _{GS} =-10V , I _D =-5.8A		30	38	m ohm
		V _{GS} =-4.5V , I _D =-4.6A		45	60	m ohm
g _{FS}	Forward Transconductance	V _{DS} =-5V , I _D =-5.8A		18		S
DYNAMIC CHARACTERISTICS ^c						
C _{ISS}	Input Capacitance	V _{DS} =-20V, V _{GS} =0V f=1.0MHz		1000		pF
C _{OSS}	Output Capacitance			123		pF
C _{RSS}	Reverse Transfer Capacitance			107		pF
SWITCHING CHARACTERISTICS ^c						
t _{D(ON)}	Turn-On Delay Time	V _{DD} =-20V I _D =-1A V _{GS} =-10V R _{GEN} = 6 ohm		18		ns
t _r	Rise Time			22		ns
t _{D(OFF)}	Turn-Off Delay Time			65		ns
t _f	Fall Time			20		ns
Q _g	Total Gate Charge	V _{DS} =-20V, I _D =-5.5A, V _{GS} =-10V		22		nC
		V _{DS} =-20V, I _D =-5.5A, V _{GS} =-4.5V		10.7		nC
Q _{gs}	Gate-Source Charge	V _{DS} =-20V, I _D =-5.5A, V _{GS} =-10V		2.1		nC
Q _{gd}	Gate-Drain Charge			6		nC
DRAIN-SOURCE DIODE CHARACTERISTICS AND MAXIMUM RATINGS						
I _S	Maximum Continuous Drain-Source Diode Forward Current				-2.0	A
V _{SD}	Diode Forward Voltage ^b	V _{GS} =0V, I _S =-2.0A		-0.81	-1.3	V

Notes

- Surface Mounted on FR4 Board, t ≤ 10sec.
- Pulse Test: Pulse Width ≤ 300us, Duty Cycle ≤ 2%.
- Guaranteed by design, not subject to production testing.
- Starting T_J=25°C, L=0.5mH, V_{DD} = 20V, V_{GS}=10V. (See Figure13)

N-Channel

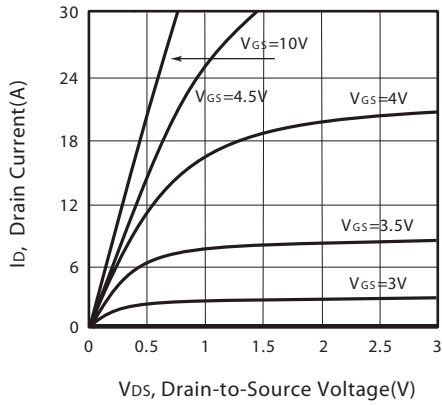

Figure 1. Output Characteristics

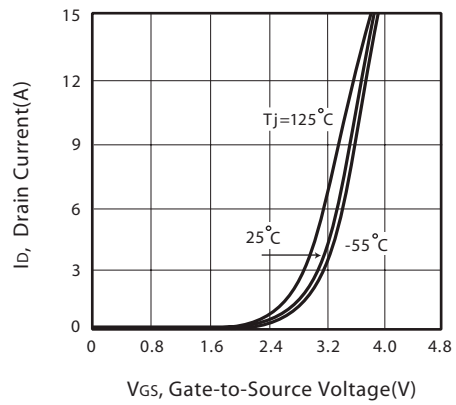

Figure 2. Transfer Characteristics

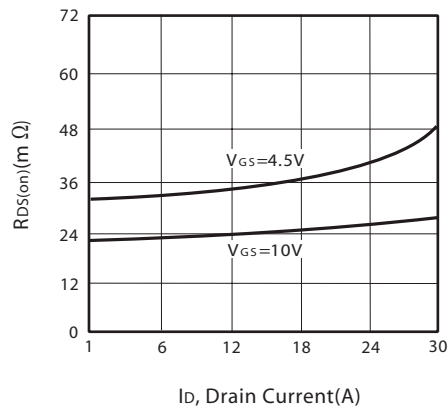

Figure 3. On-Resistance vs. Drain Current and Gate Voltage

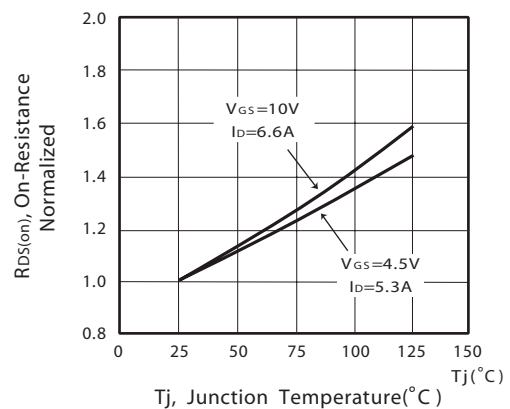

Figure 4. On-Resistance Variation with Drain Current and Temperature

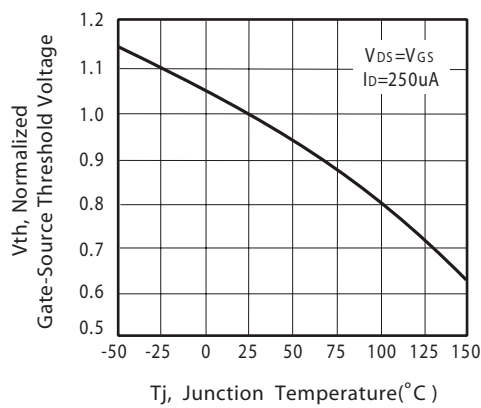

Figure 5. Gate Threshold Variation with Temperature

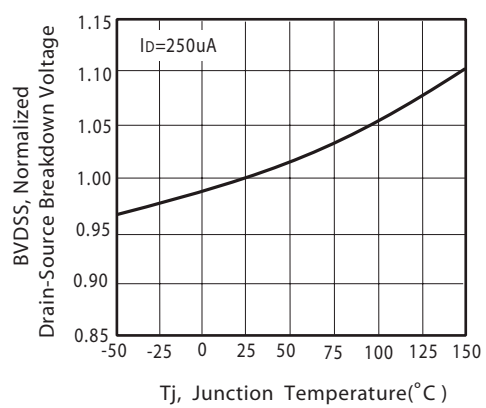

Figure 6. Breakdown Voltage Variation with Temperature

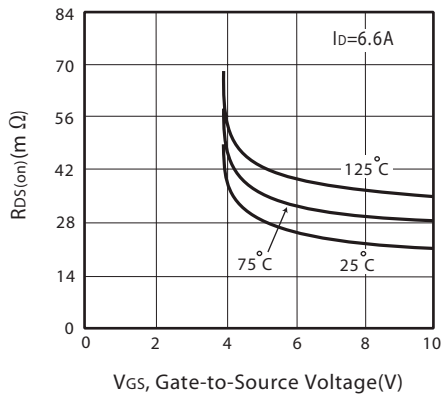

Figure 7. On-Resistance vs. Gate-Source Voltage

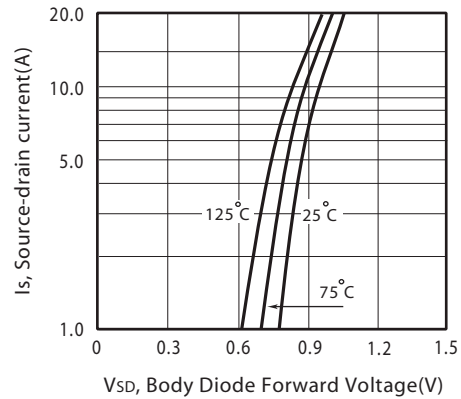

Figure 8. Body Diode Forward Voltage Variation with Source Current

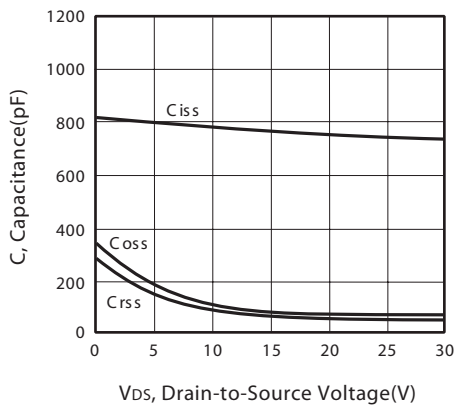

Figure 9. Capacitance

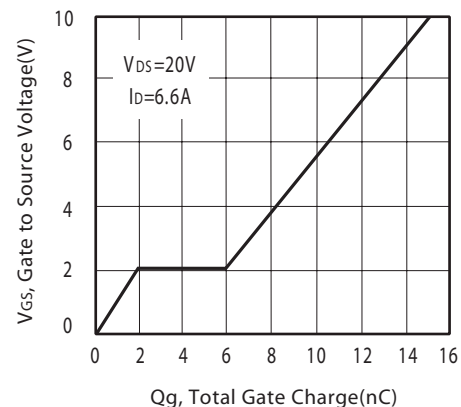

Figure 10. Gate Charge

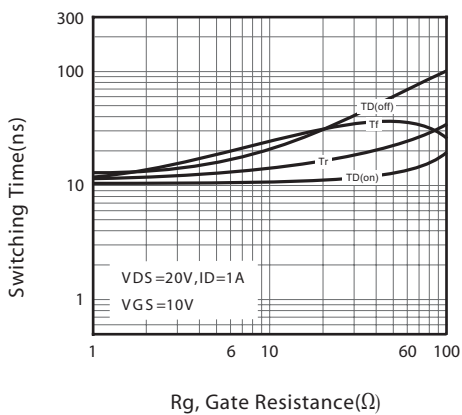

Figure 11. switching characteristics

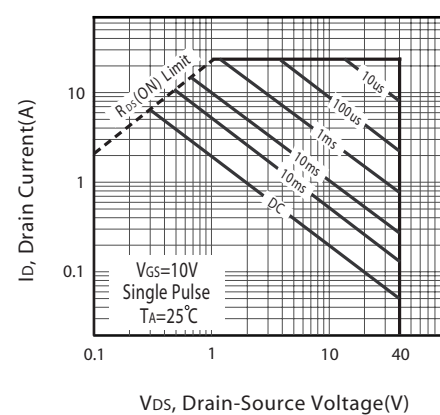
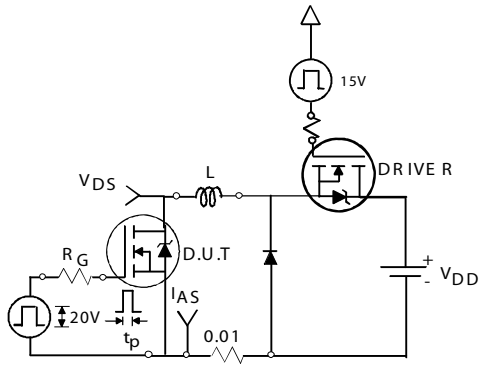
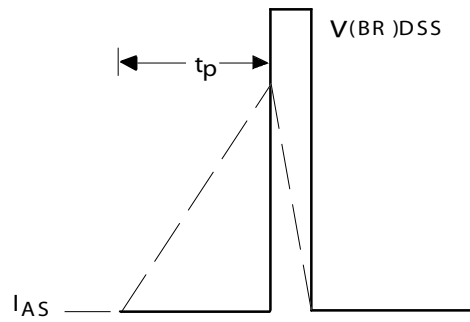

Figure 12. Maximum Safe Operating Area



Unclamped Inductive Test Circuit

Figure 13a.



Unclamped Inductive Waveforms

Figure 13b.

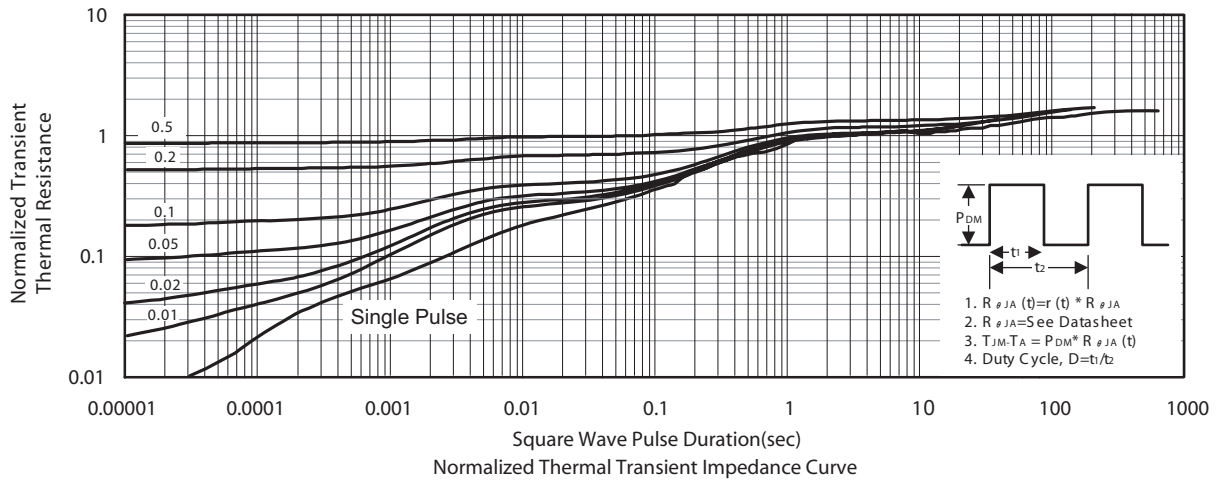

P-Channel

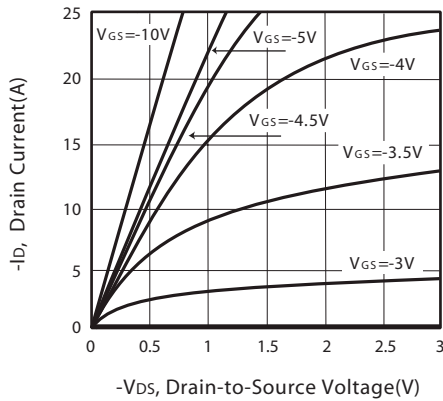

Figure 1. Output Characteristics

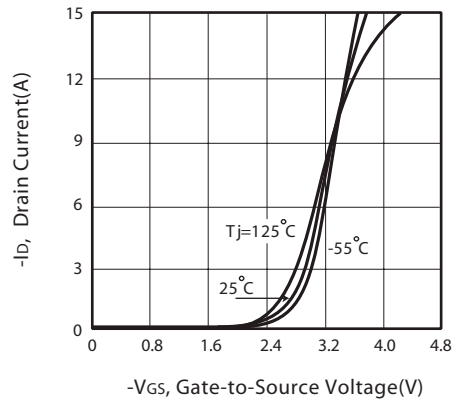

Figure 2. Transfer Characteristics

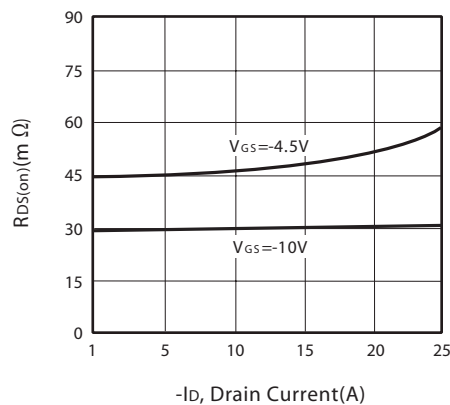

Figure 3. On-Resistance vs. Drain Current and Gate Voltage

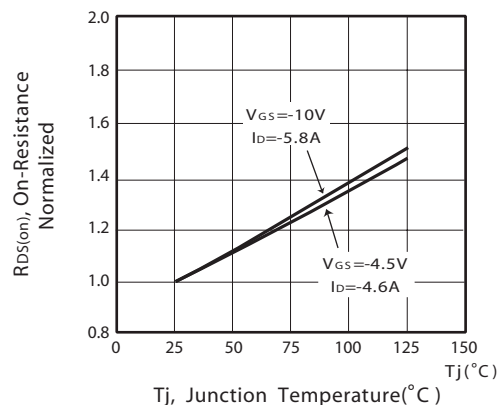

Figure 4. On-Resistance Variation with Drain Current and Temperature

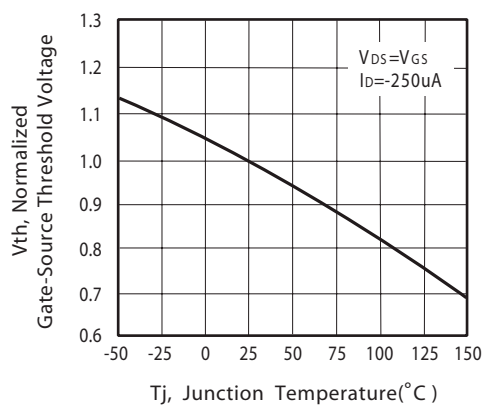

Figure 5. Gate Threshold Variation with Temperature

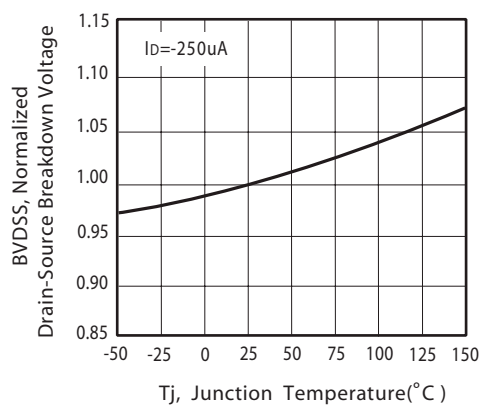

Figure 6. Breakdown Voltage Variation with Temperature

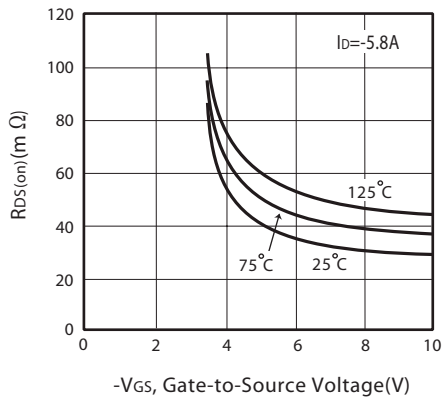

Figure 7. On-Resistance vs. Gate-Source Voltage

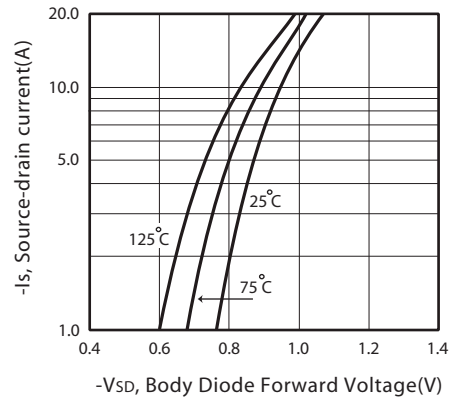

Figure 8. Body Diode Forward Voltage Variation with Source Current

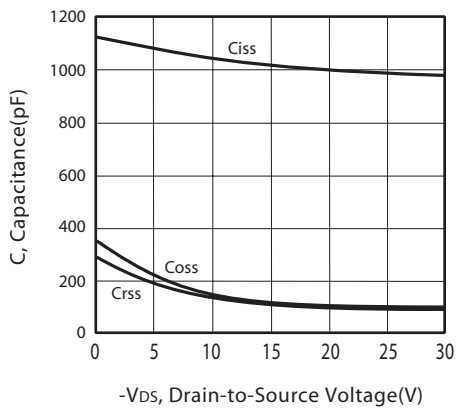

Figure 9. Capacitance

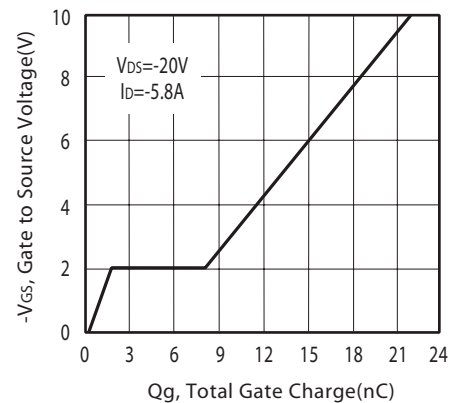

Figure 10. Gate Charge

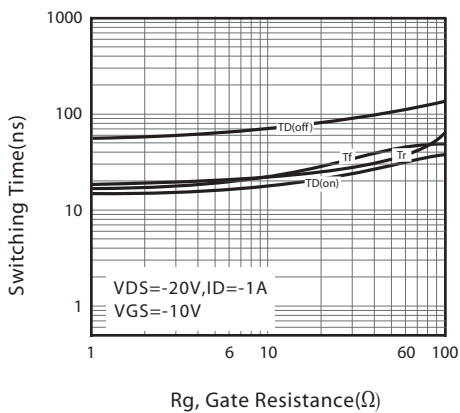

Figure 11. switching characteristics

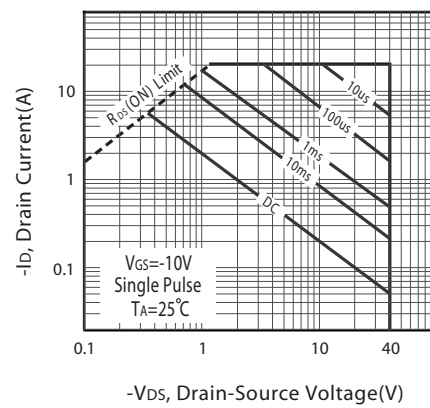
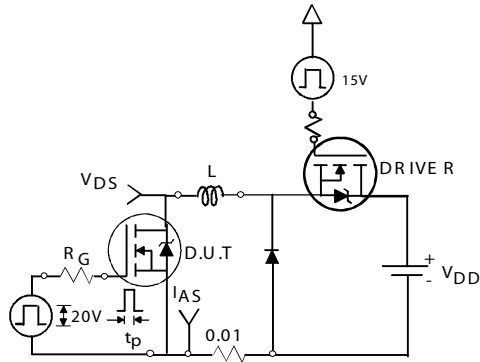
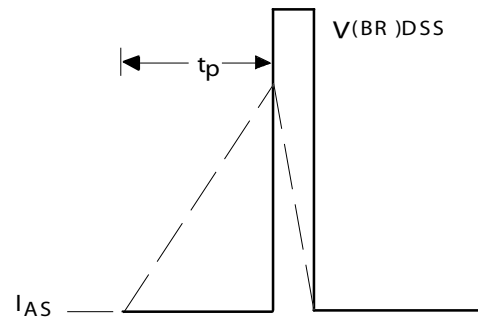

Figure 12. Maximum Safe Operating Area



Unclamped Inductive Test Circuit

Figure 13a.



Unclamped Inductive Waveforms

Figure 13b.

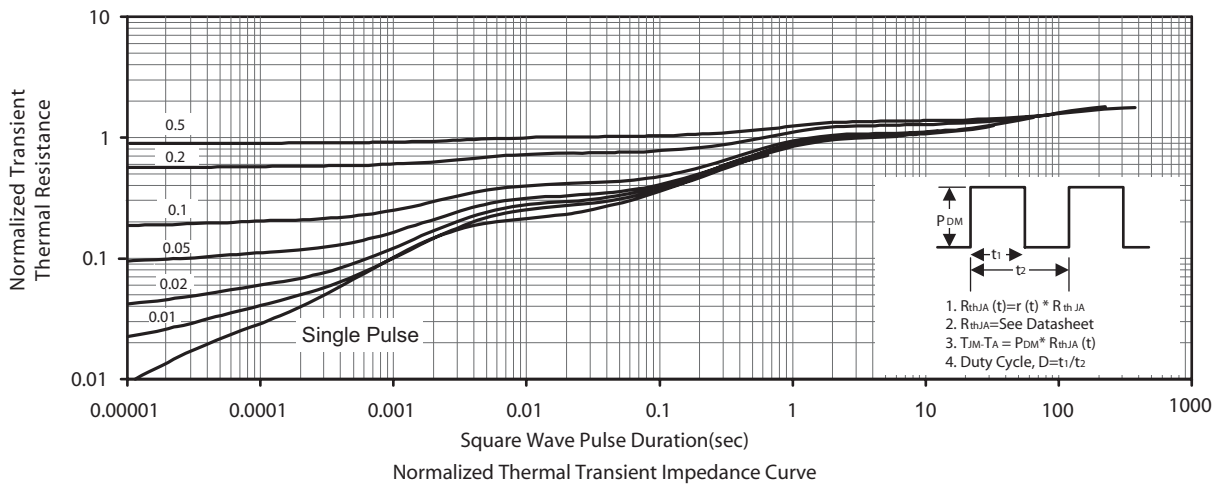

PACKAGE OUTLINE DIMENSIONS

SO-8

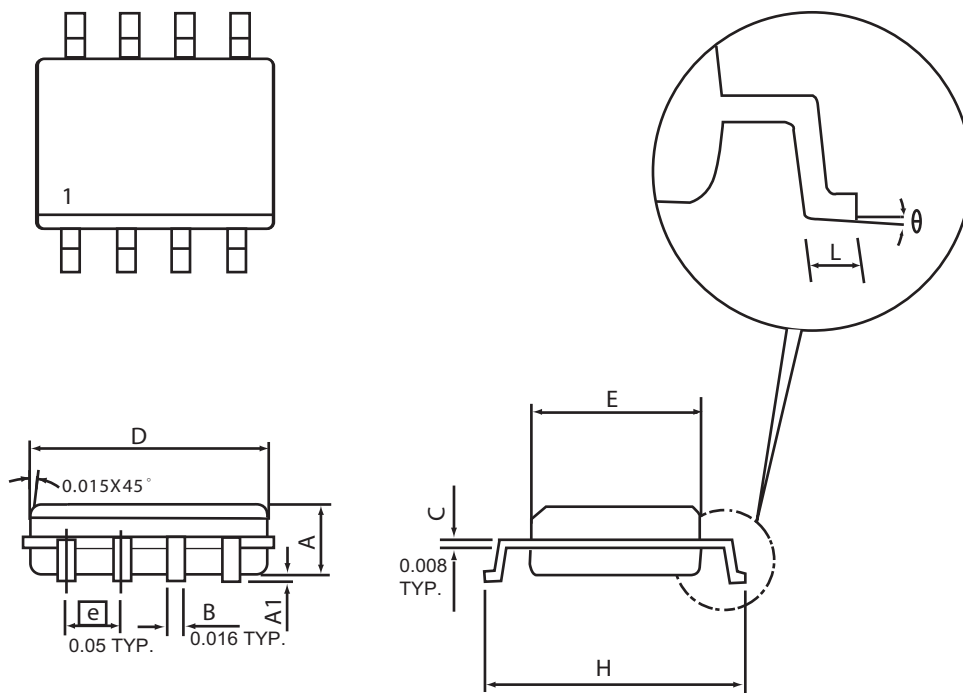

SYMBOLS	MILLIMETERS		INCHES	
	MIN	MAX	MIN	MAX
A	1.35	1.75	0.053	0.069
A1	0.10	0.25	0.004	0.010
D	4.80	4.98	0.189	0.196
E	3.81	3.99	0.150	0.157
H	5.79	6.20	0.228	0.244
L	0.41	1.27	0.016	0.050
θ	0°	8°	0°	8°

Notes : SO-8 package weight : 0.083g

SO-8 Tape and Reel Data

SO-8 Carrier Tape

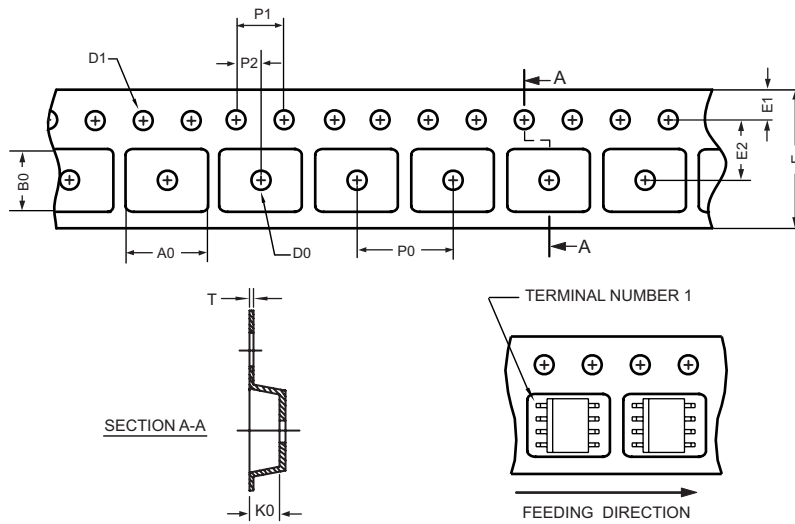

unit:mm

PACKAGE	A0	B0	K0	D0	D1	E	E1	E2	P0	P1	P2	T
SOP 8N 150mil	6.50 ±0.15	5.25 ±0.10	2.10 ±0.10	φ 1.5 (MIN)	φ 1.55 ±0.10	12.0 +0.3 - 0.1	1.75 ±0.10	5.5 ±0.10	8.0 ±0.10	4.0 ±0.10	2.0 ±0.10	0.30 ±0.013

SO-8 Reel

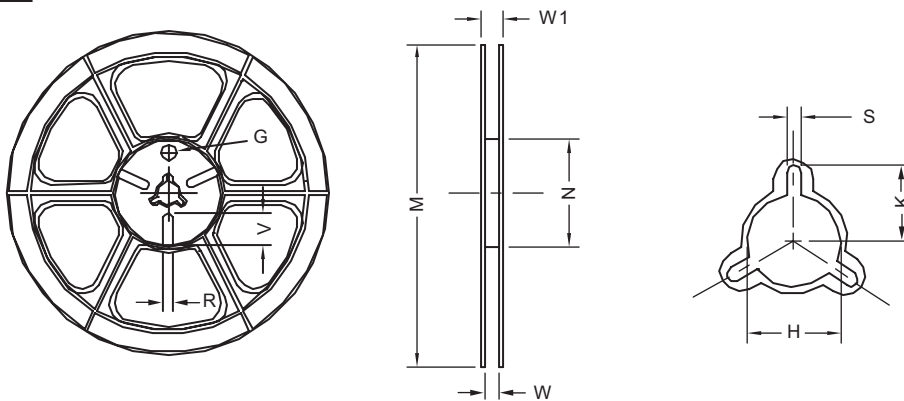

UNIT:mm

TAPE SIZE	REEL SIZE	M	N	W	W1	H	K	S	G	R	V
12 mm	φ 330	330 ± 1	62 ±1.5	12.4 + 0.2	16.8 - 0.4	φ 12.75 + 0.15	---	2.0 ±0.15	---	---	---