



Dual Enhancement Mode Field Effect Transistor (N and P Channel)

PRODUCT SUMMARY (N-Channel)		
VDSS	ID	RDS(ON) (mΩ) Max
40V	6A	26 @ VGS = 10V
		33 @ VGS = 4.5V

PRODUCT SUMMARY (P-Channel)		
VDSS	ID	RDS(ON) (mΩ) Max
-40V	-5A	42 @ VGS = -10V
		62 @ VGS = -4.5V



ABSOLUTE MAXIMUM RATINGS (TA=25°C unless otherwise noted)

Parameter	Symbol	N-Channel	P-Channel	Unit	
Drain-Source Voltage	VDS	40	-40	V	
Gate-Source Voltage	VGS	±20	±20	V	
Drain Current-Continuous ^a @Ta	ID	25°C	6	-5	A
		70°C	5.1	-4.2	A
-Pulsed ^b	IDM	28	-20	A	
Drain-Source Diode Forward Current ^a	IS	1.7	-1.7	A	
Maximum Power Dissipation ^a	PD	Ta=25°C	2	W	
		Ta=70°C	1.44		
Operating Junction and Storage Temperature Range	TJ, TSTG	-55 to 150		°C	

THERMAL CHARACTERISTICS

Thermal Resistance, Junction-to-Ambient ^a	RθJA	62.5	°C/W
--	------	------	------

STM8457

N-Channel ELECTRICAL CHARACTERISTICS (TA=25°C unless otherwise noted)

Parameter	Symbol	Condition	Min	Typ ^c	Max	Unit
OFF CHARACTERISTICS						
Drain-Source Breakdown Voltage	BV _{DSS}	V _{GS} = 0V, I _D = 250uA	40			V
Zero Gate Voltage Drain Current	I _{DSS}	V _{DS} = 32V, V _{GS} = 0V			1	uA
Gate-Body Leakage	I _{GSS}	V _{GS} ± 20V, V _{DS} = 0V			±10	uA
ON CHARACTERISTICS ^b						
Gate Threshold Voltage	V _{GS(th)}	V _{DS} = V _{GS} , I _D = 250uA	1.4	1.8	3.0	V
Drain-Source On-State Resistance	R _{DS(ON)}	V _{GS} = 10V, I _D = 5A		20	26	m ohm
		V _{GS} = 4.5V, I _D = 4A		27	33	m ohm
On-State Drain Current	I _{D(ON)}	V _{DS} = 5V, V _{GS} = 10V	20			A
Forward Transconductance	g _{FS}	V _{DS} = 5V, I _D = 5A		15		S
DYNAMIC CHARACTERISTICS ^c						
Input Capacitance	C _{ISS}	V _{DS} = 20V, V _{GS} = 0V f = 1.0MHz		750		pF
Output Capacitance	C _{OSS}			125		pF
Reverse Transfer Capacitance	C _{RSS}			75		pF
SWITCHING CHARACTERISTICS ^c						
Turn-On Delay Time	t _{D(ON)}	V _{DD} = 20V I _D = 1 A V _{GS} = 10V R _{GEN} = 3.3 ohm		13		ns
Rise Time	t			11		ns
Turn-Off Delay Time	t _{D(OFF)}			37		ns
Fall Time	t			10		ns
Total Gate Charge	Q _g	V _{DS} = 24V, I _D = 5A, V _{GS} = 10V		12.5		nC
		V _{DS} = 24V, I _D = 5A, V _{GS} = 4.5V		6.4		nC
Gate-Source Charge	Q _{gs}	V _{DS} = 24V, I _D = 5 A V _{GS} = 4.5V		1.8		nC
Gate-Drain Charge	Q _{gd}			3.6		nC

STM8457

P-Channel ELECTRICAL CHARACTERISTICS (TA=25°C unless otherwise noted)

Parameter	Symbol	Condition	Min	Typ ^c	Max	Unit
OFF CHARACTERISTICS						
Drain-Source Breakdown Voltage	BV _{DSS}	V _{GS} =0V, I _D =-250uA	-40			V
Zero Gate Voltage Drain Current	I _{DSS}	V _{DS} =-32V, V _{GS} =0V			-1	uA
Gate-Body Leakage	I _{GSS}	V _{GS} ± 20V, V _{DS} =0V			±10	uA
ON CHARACTERISTICS ^b						
Gate Threshold Voltage	V _{GS(th)}	V _{DS} =V _{GS} , I _D =-250uA	-1.4	-1.8	-3.0	V
Drain-Source On-State Resistance	R _{DS(ON)}	V _{GS} =-10V, I _D =-4A		35	42	m ohm
		V _{GS} =-4.5V, I _D =-3A		54	62	m ohm
On-State Drain Current	I _{D(ON)}	V _{DS} =-5V, V _{GS} =-10V	16			A
Forward Transconductance	g _{FS}	V _{DS} =-5V, I _D =-4A		10		S
DYNAMIC CHARACTERISTICS ^c						
Input Capacitance	C _{ISS}	V _{DS} =-20V, V _{GS} =0V f=1.0MHz		960		pF
Output Capacitance	C _{OSS}			142		pF
Reverse Transfer Capacitance	C _{RSS}			75		pF
SWITCHING CHARACTERISTICS ^c						
Turn-On Delay Time	t _{D(ON)}	V _D =-20V I _D =-1A V _{GEN} =-10V R _{GEN} =3.3 ohm		15		ns
Rise Time	t			13		ns
Turn-Off Delay Time	t _{D(OFF)}			66		ns
Fall Time	t			25		ns
Total Gate Charge	Q _g	V _{DS} =-24V, I _D =-4A, V _{GS} =-10V		15.6		nC
		V _{DS} =-24V, I _D =-4A, V _{GS} =-4.5V		7.7		nC
Gate-Source Charge	Q _{gs}	V _{DS} =-24V, I _D =-4A V _{GS} =-4.5V		2.3		nC
Gate-Drain Charge	Q _{gd}			4.3		nC

STM8457

ELECTRICAL CHARACTERISTICS ($T_A=25^\circ\text{C}$ unless otherwise noted)

Parameter	Symbol	Condition	Min	Typ ^c	Max	Unit
DRAIN-SOURCE DIODE CHARACTERISTICS^b						
Diode Forward Voltage	V_{SD}	$V_{GS} = 0V, I_S = 1.7A$	N-Ch	0.78	1.2	V
		$V_{GS} = 0V, I_S = -1.7A$	P-Ch	-0.77	-1.2	

Notes

- a. Surface Mounted on FR4 Board, $t \leq 10\text{sec}$.
 - b. Pulse Test: Pulse Width $\leq 300\mu\text{s}$, Duty Cycle $\leq 2\%$.
 - c. Guaranteed by design, not subject to production testing.
- N-Channel

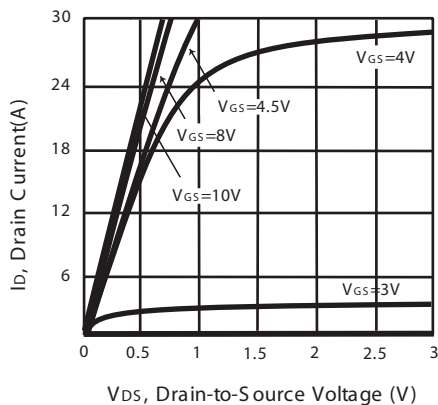

Figure 1. Output Characteristics

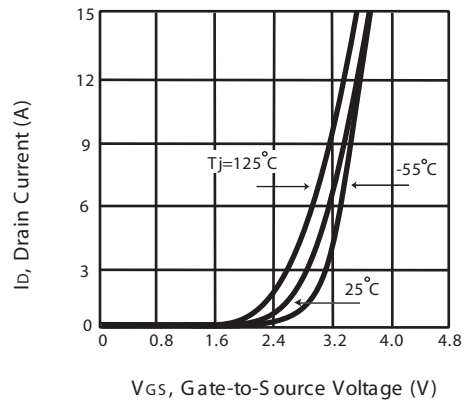

Figure 2. Transfer Characteristics

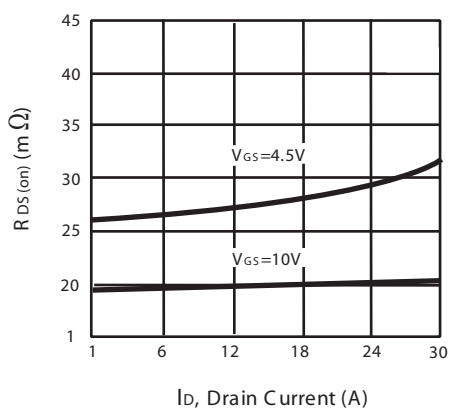

Figure 3. On-Resistance vs. Drain Current and Gate Voltage

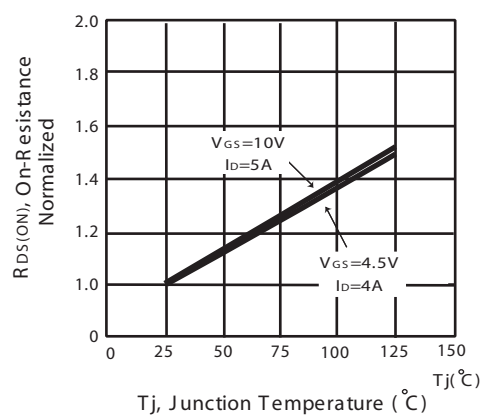

Figure 4. On-Resistance Variation with Drain Current and Temperature

STM8457

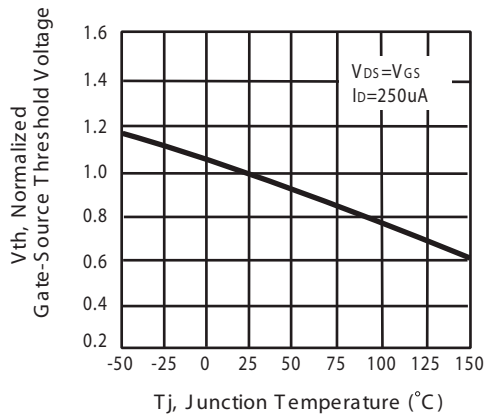

Figure 5. Gate Threshold Variation with Temperature

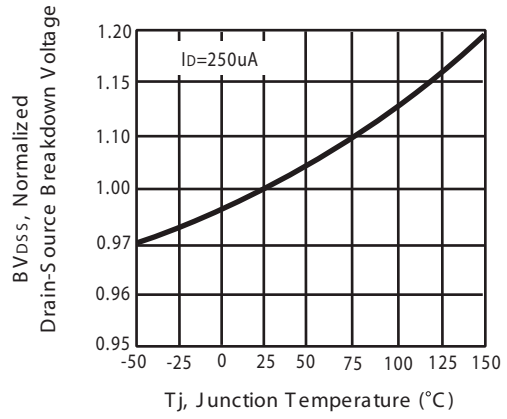

Figure 6. Breakdown Voltage Variation with Temperature

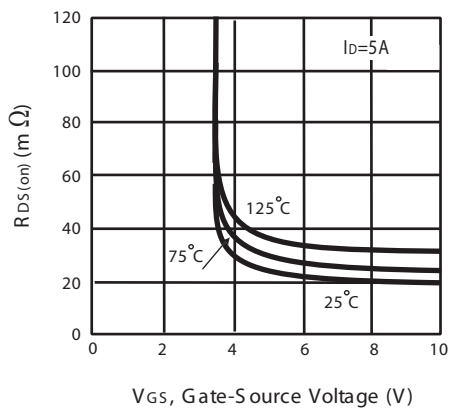

Figure 7. On-Resistance vs. Gate-Source Voltage

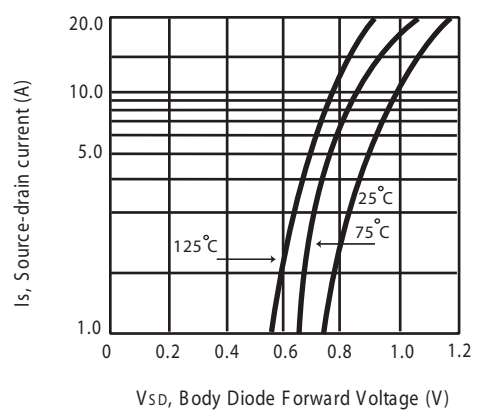

Figure 8. Body Diode Forward Voltage Variation with Source Current

STM8457

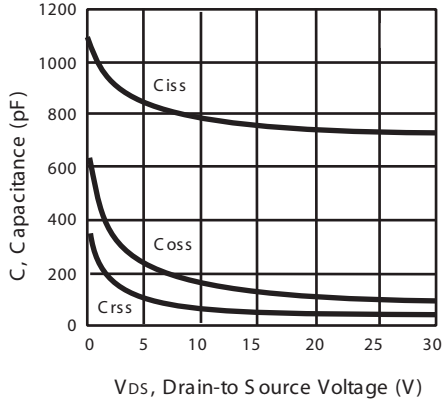

Figure 9. Capacitance

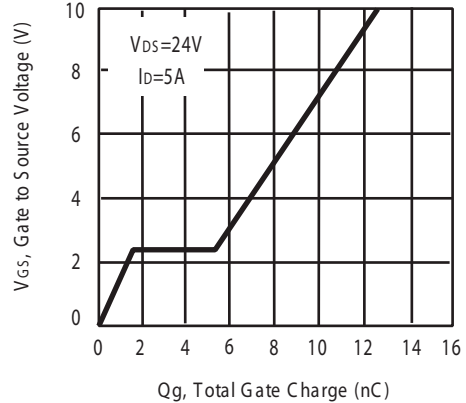

Figure 10. Gate Charge

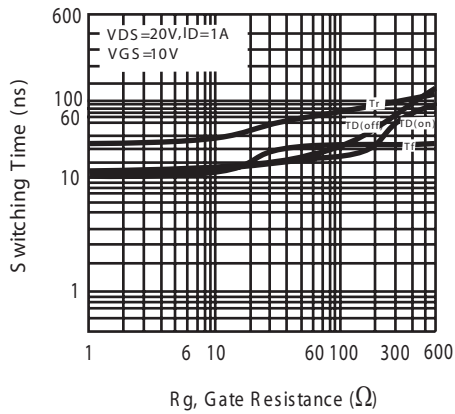

Figure 11. switching characteristics

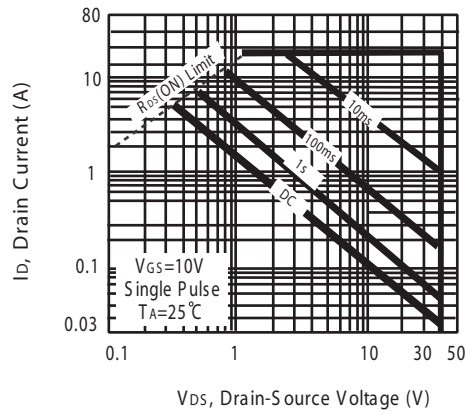
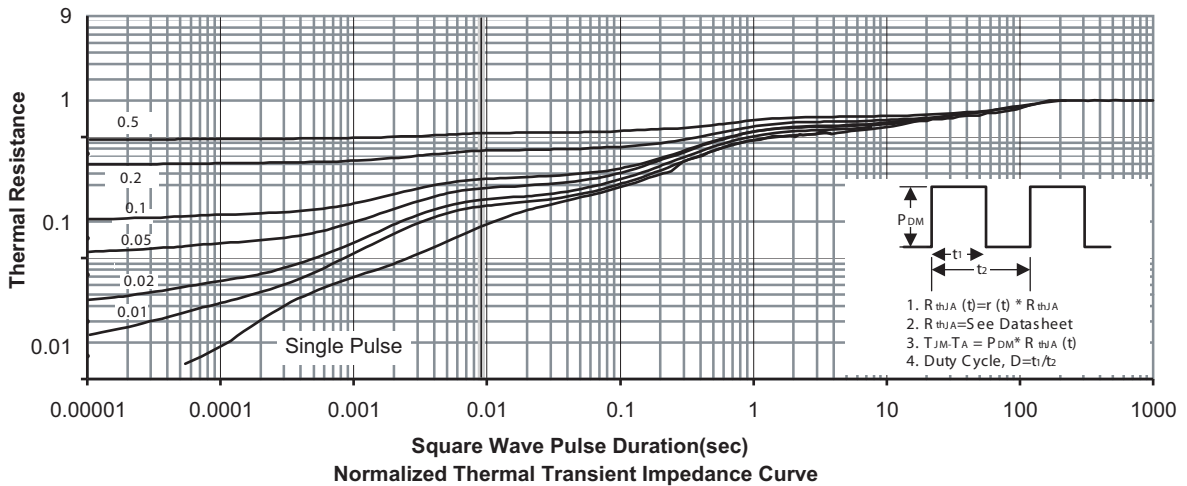

Figure 12. Maximum Safe Operating Area



STM8457

P-Channel

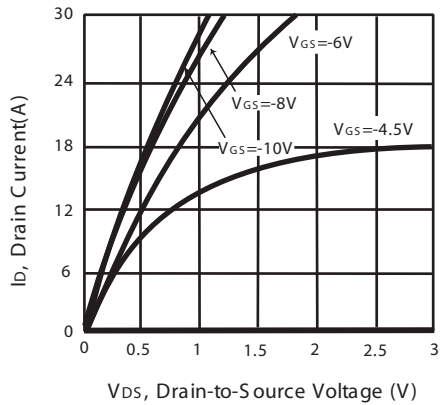

Figure 1. Output Characteristics

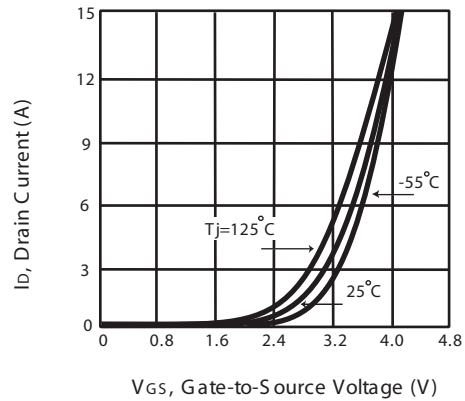

Figure 2. Transfer Characteristics

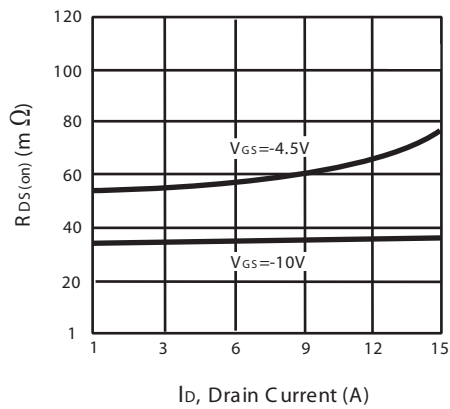

Figure 3. On-Resistance vs. Drain Current and Gate Voltage

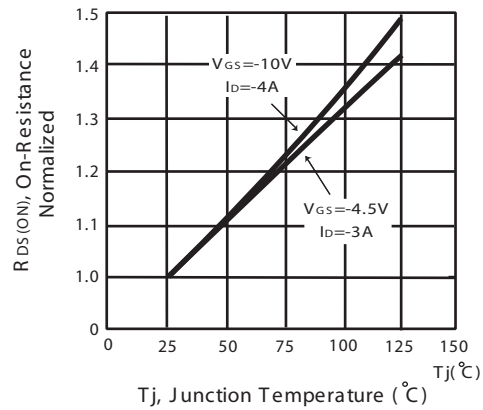

Figure 4. On-Resistance Variation with Drain Current and Temperature

STM8457

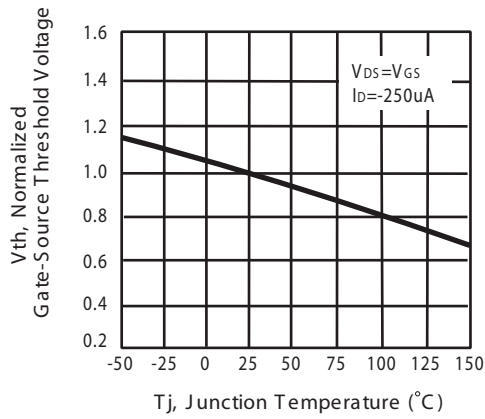

Figure 5. Gate Threshold Variation with Temperature

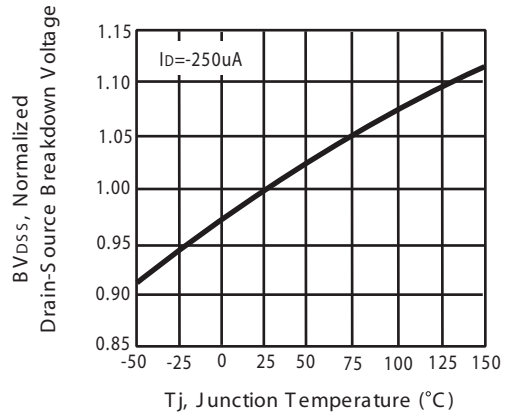

Figure 6. Breakdown Voltage Variation with Temperature

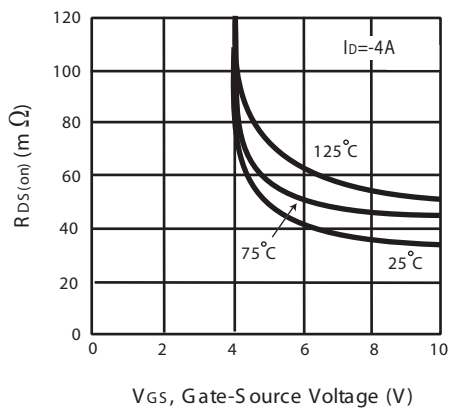

Figure 7. On-Resistance vs. Gate-Source Voltage

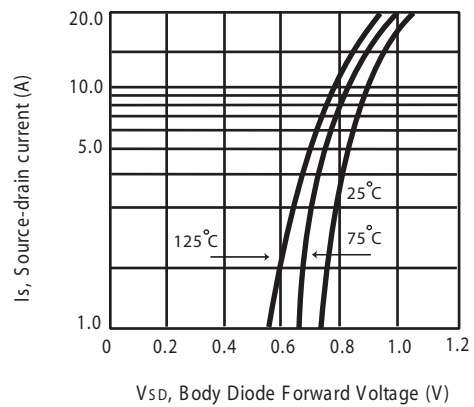

Figure 8. Body Diode Forward Voltage Variation with Source Current

STM8457

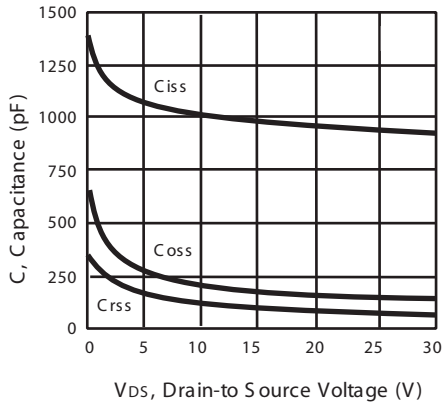

Figure 9. Capacitance

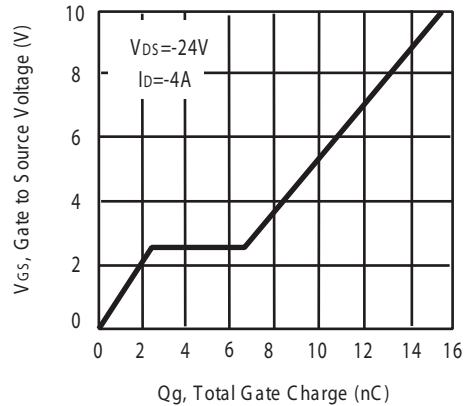

Figure 10. Gate Charge

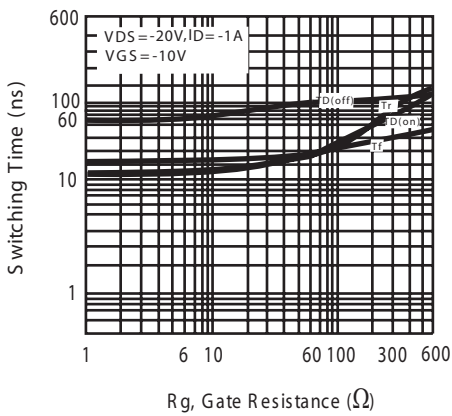

Figure 11. switching characteristics

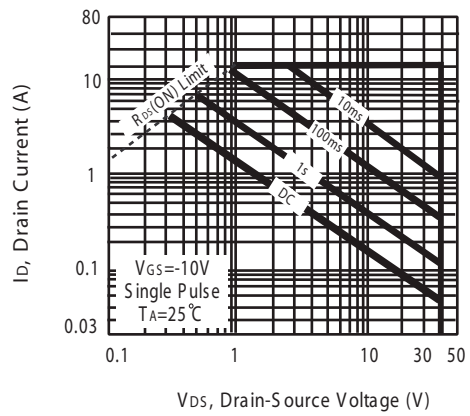
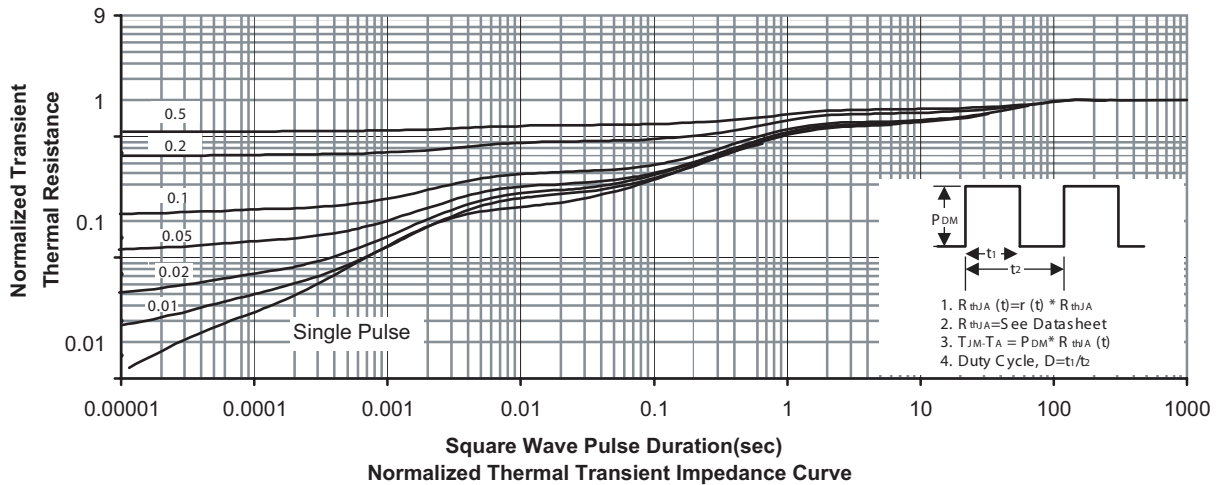

Figure 12. Maximum Safe Operating Area



STM8457

PACKAGE OUTLINE DIMENSIONS

SO-8

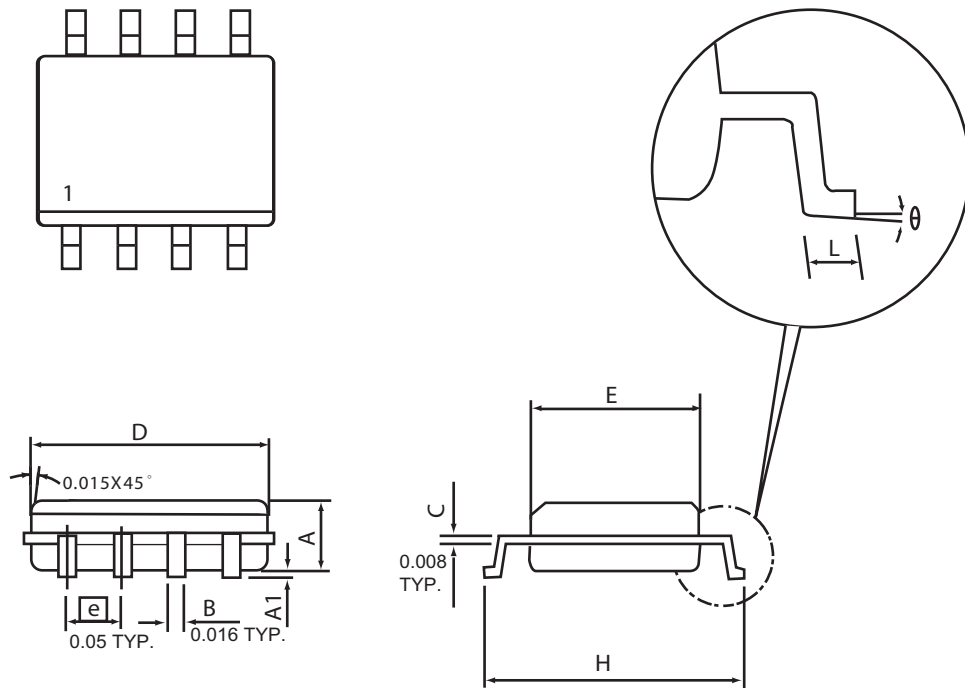

SYMBOLS	MILLIMETERS		INCHES	
	MIN	MAX	MIN	MAX
A	1.35	1.75	0.053	0.069
A1	0.10	0.25	0.004	0.010
D	4.80	4.98	0.189	0.196
E	3.81	3.99	0.150	0.157
H	5.79	6.20	0.228	0.244
L	0.41	1.27	0.016	0.050
θ	0°	8°	0°	8°

STM8457

SO-8 Tape and Reel Data

SO-8 Carrier Tape

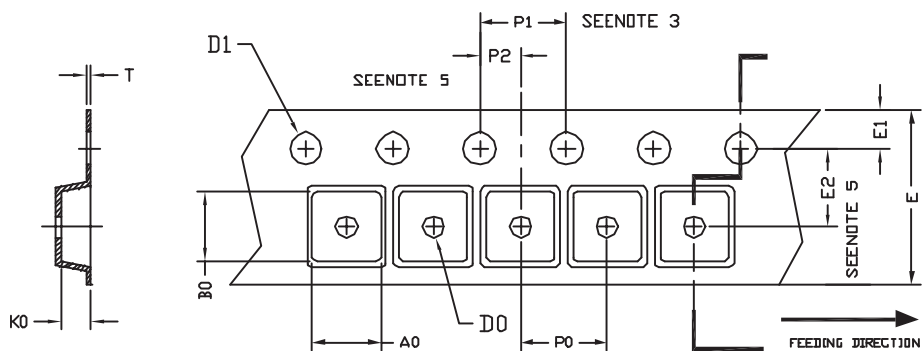

unit:mm

PACKAGE	A0	B0	K0	D0	D1	E	E1	E2	P0	P1	P2	T
SOP 8N 150mil	6.40	5.20	2.10	$\phi 1.5$ (MIN)	$\phi 1.5$ + 0.1 - 0.0	12.0 ± 0.3	1.75	5.5 ± 0.05	8.0	4.0	2.0 ± 0.05	0.3 ± 0.05

SO-8 Reel

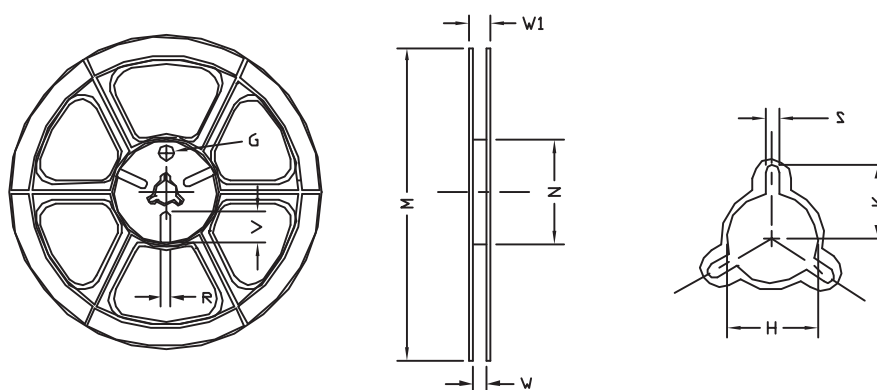

UNIT:mm

TAPE SIZE	REEL SIZE	M	N	W	W1	H	K	S	G	R	V
12 mm	$\phi 330$	330 ± 1	62 ± 1.5	12.4 + 0.2	16.8 - 0.4	$\phi 12.75$ + 0.15	---	2.0 ± 0.15	---	---	---