

**N-Channel Logic Level Enhancement Mode Field Effect Transistor****PRODUCT SUMMARY**

V _{DSS}	I _D	R _{DS(ON)} (mΩ) Typ
100V	35A	30 @ V _{GS} =10V

FEATURES

- Super high dense cell design for extremely low R_{DS(ON)}.
- High power and current handling capability.
- TO-220 package.

**ABSOLUTE MAXIMUM RATINGS (T_C=25°C unless otherwise noted)**

Symbol	Parameter	Limit	Units
V _{DS}	Drain-Source Voltage	100	V
V _{GS}	Gate-Source Voltage	±20	V
I _D	Drain Current-Continuous ^a	T _C =25°C	35
		T _C =70°C	29.3
I _{DM}	-Pulsed ^a	103	A
P _D	Maximum Power Dissipation	T _C =25°C	75
		T _C =70°C	52.5
T _J , T _{STG}	Operating Junction and Storage Temperature Range	-55 to 175	°C

THERMAL CHARACTERISTICS

R _{θ JC}	Thermal Resistance, Junction-to-Case	2	°C/W
R _{θ JA}	Thermal Resistance, Junction-to-Ambient	62.5	°C/W

STP35N10

Ver 1.1

ELECTRICAL CHARACTERISTICS (T_C=25°C unless otherwise noted)

Symbol	Parameter	Conditions	Min	Typ	Max	Units
OFF CHARACTERISTICS						
BV _{DSS}	Drain-Source Breakdown Voltage	V _{GS} =0V , I _D =250uA	100			V
I _{DSS}	Zero Gate Voltage Drain Current	V _{DS} =80V , V _{GS} =0V			1	uA
I _{GSS}	Gate-Body leakage current	V _{GS} = ±20V , V _{DS} =0V			±100	nA
ON CHARACTERISTICS						
V _{GS(th)}	Gate Threshold Voltage	V _{DS} =V _{GS} , I _D =250uA	1.5	2.5	3.5	V
R _{DS(ON)}	Drain-Source On-State Resistance	V _{GS} =10V , I _D =17.5A		30	36	m ohm
g _{FS}	Forward Transconductance	V _{DS} =10V , I _D =17.5A		12		S
DYNAMIC CHARACTERISTICS ^b						
C _{ISS}	Input Capacitance	V _{DS} =25V, V _{GS} =0V f=1.0MHz		1490		pF
C _{OSS}	Output Capacitance			155		pF
C _{RSS}	Reverse Transfer Capacitance			100		pF
SWITCHING CHARACTERISTICS ^b						
t _{D(ON)}	Turn-On DelayTime	V _{DD} =50V I _D =1A		36		ns
t _r	Rise Time			41		ns
t _{D(OFF)}	Turn-Off DelayTime	V _{GS} =10V R _{GEN} = 6 ohm		39		ns
t _f	Fall Time			22		ns
Q _g	Total Gate Charge	V _{DS} =50V, I _D =17.5A, V _{GS} =10V		19		nC
Q _{gs}	Gate-Source Charge	V _{DS} =50V, I _D =17.5A, V _{GS} =10V		2.6		nC
Q _{gd}	Gate-Drain Charge			10		nC
DRAIN-SOURCE DIODE CHARACTERISTICS						
V _{SD}	Diode Forward Voltage	V _{GS} =0V, I _S =5A		0.8	1.3	V
Notes a. Drain current limited by maximum junction temperature. b. Guaranteed by design, not subject to production testing.						

Apr,22,2014

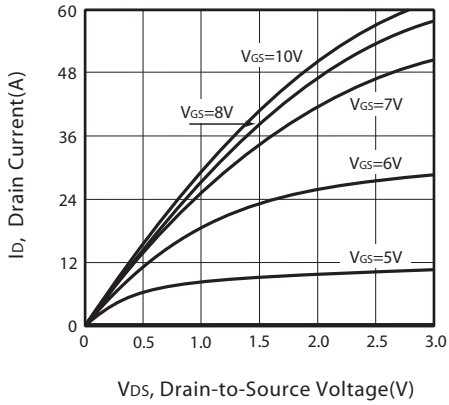

Figure 1. Output Characteristics

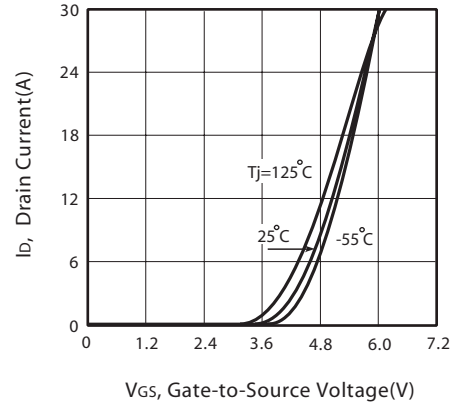

Figure 2. Transfer Characteristics

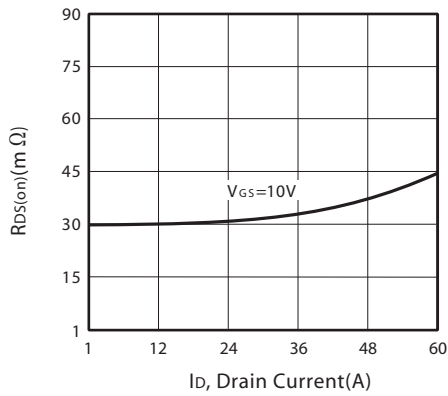

Figure 3. On-Resistance vs. Drain Current and Gate Voltage

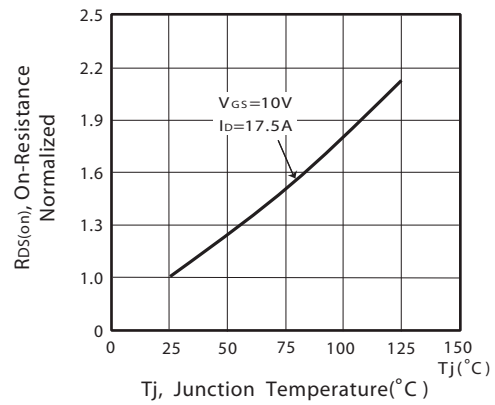

Figure 4. On-Resistance Variation with Drain Current and Temperature

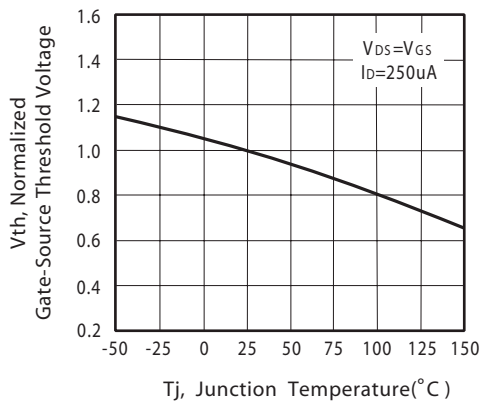

Figure 5. Gate Threshold Variation with Temperature

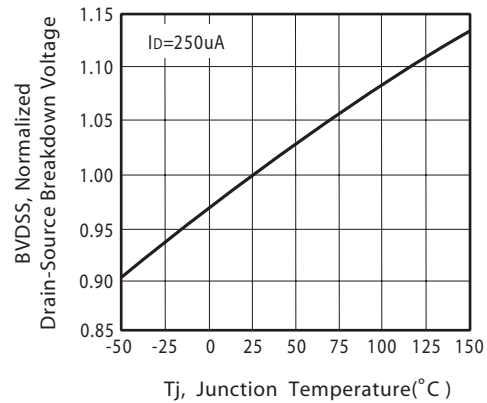

Figure 6. Breakdown Voltage Variation with Temperature

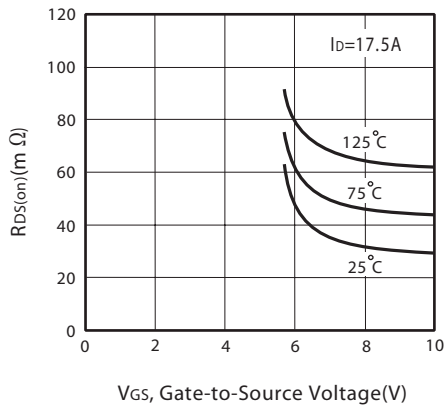

Figure 7. On-Resistance vs. Gate-Source Voltage

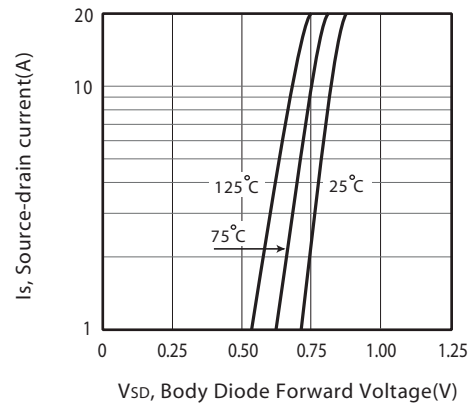

Figure 8. Body Diode Forward Voltage Variation with Source Current

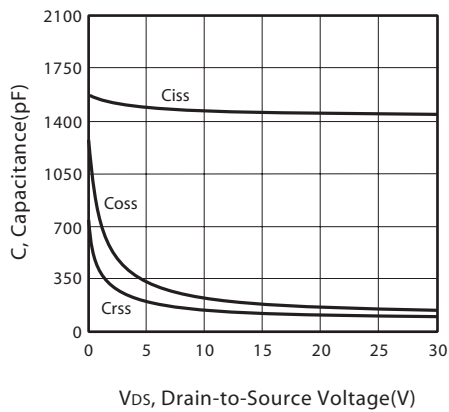

Figure 9. Capacitance

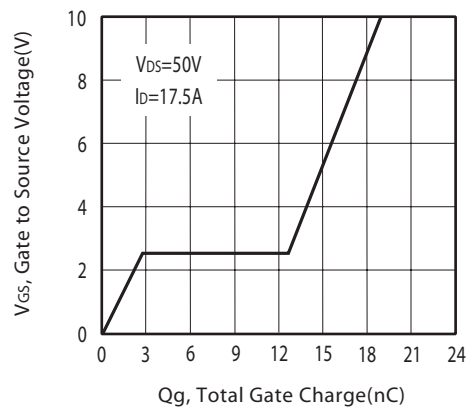

Figure 10. Gate Charge

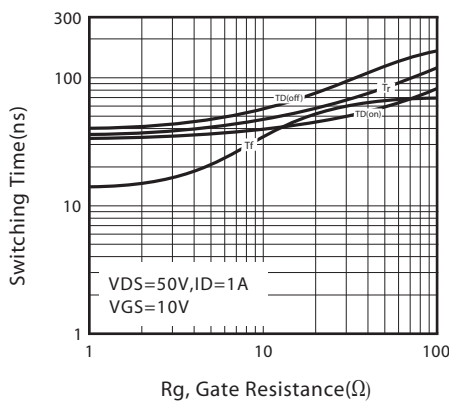

Figure 11. switching characteristics

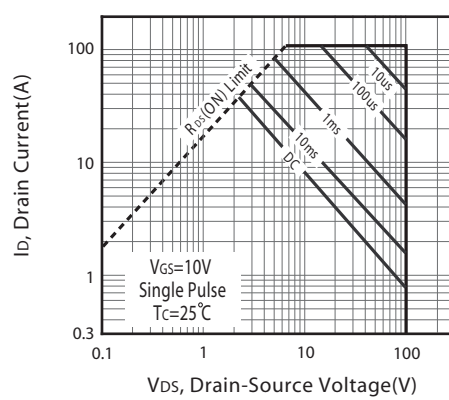
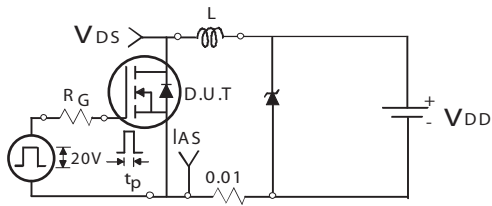

Figure 12. Maximum Safe Operating Area

STP35N10

Ver 1.1



Unclamped Inductive Test Circuit

Figure 13a.

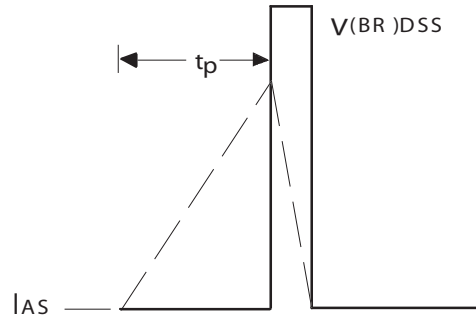

Unclamped Inductive Waveforms

Figure 13b.

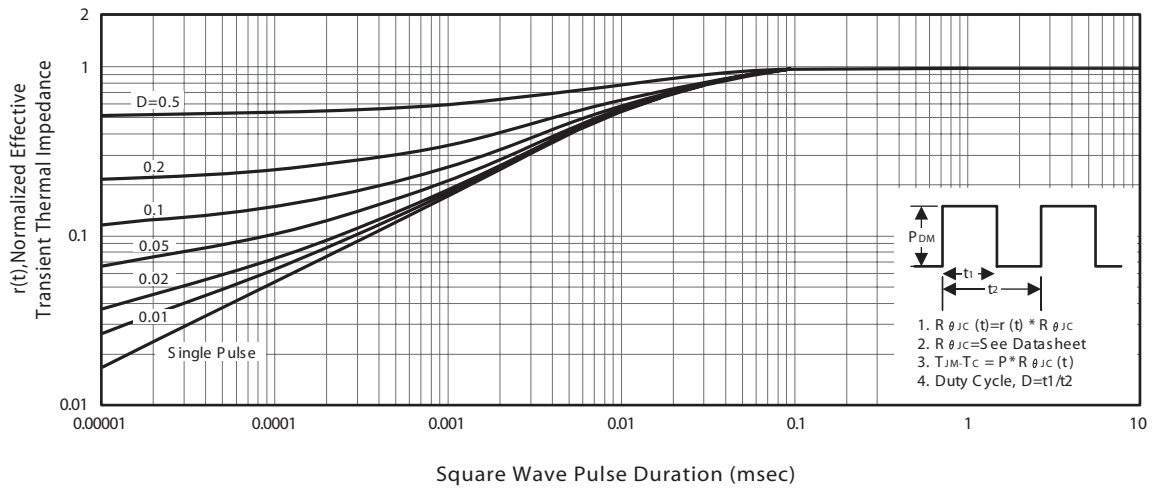

Figure 14. Normalized Thermal Transient Impedance Curve

STP35N10

Ver 1.1

PACKAGE OUTLINE DIMENSIONS

TO-220

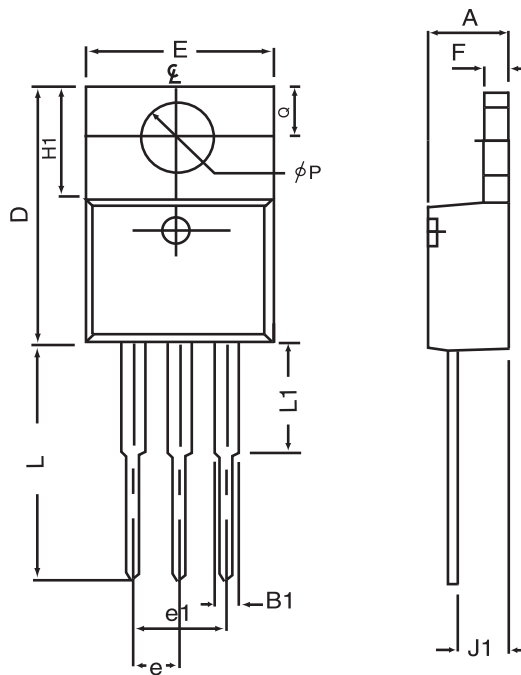

SYMBOLS	MILLIMETERS		INCHES	
	MIN	MAX	MIN	MAX
A	4.32	4.80	0.170	0.189
B1	1.27	1.65	0.050	0.630
D	14.6	16.00	0.575	0.610
E	9.70	10.41	0.382	0.410
e	2.34	2.74	0.092	0.108
e1	4.68	5.48	0.184	0.216
F	1.14	1.40	0.045	0.055
H1	5.97	6.73	0.235	0.265
J1	2.20	2.79	0.087	0.110
L	12.88	14.22	0.507	0.560
L1	3.00	6.35	0.120	0.250
phi P	3.50	3.94	0.138	0.155
Q	2.54	3.05	0.100	0.120

Apr,22,2014

STP35N10

Ver 1.1

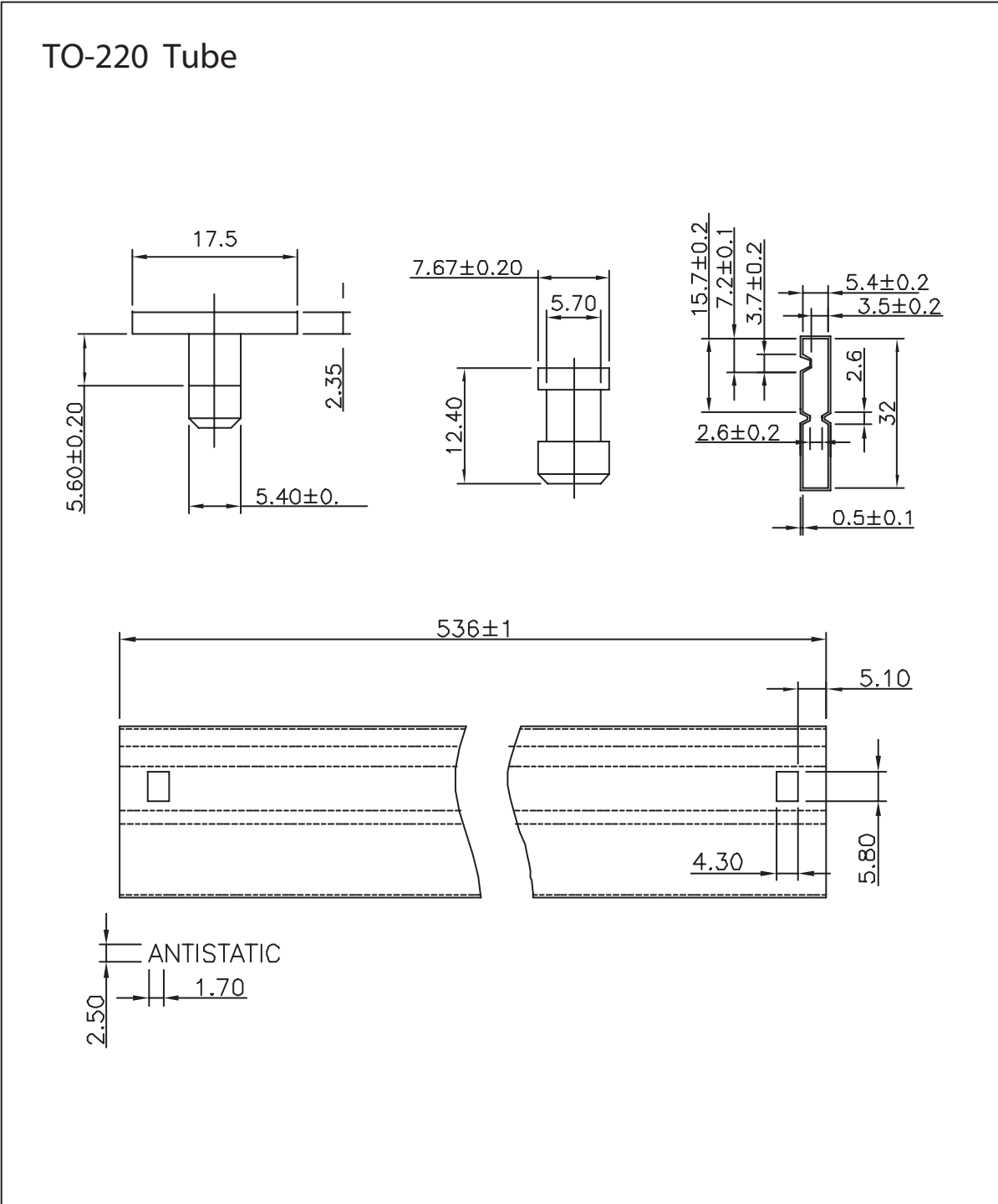

Apr,22,2014

STP35N10

Ver 1.1

TOP MARKING DEFINITION

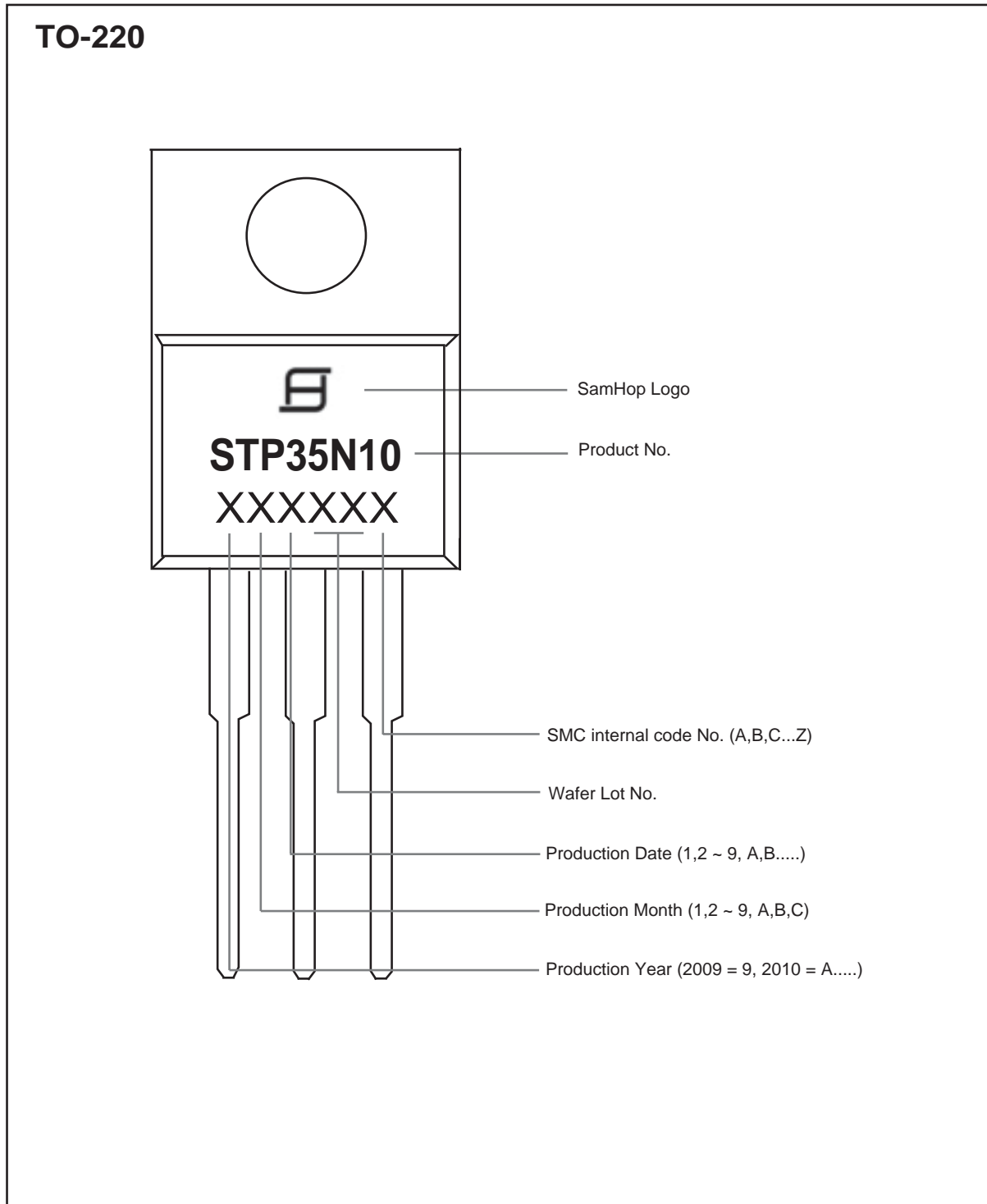

Apr,22,2014