



STS 2306E

SamHop Microelectronics Corp.

Jan. 10 2008 Ver1.0

N-Channel Enhancement Mode Field Effect Transistor

PRODUCT SUMMARY		
V _{DS}	I _D	R _{DS(ON)} (mΩ) Max
20V	6.5A	30 @ V _{GS} = 4.5V 40 @ V _{GS} = 2.5V

FEATURES

- Super high dense cell design for low R_{DS(ON)}.
- Rugged and reliable.
- Surface Mount Package.
- ESD Protected.



ABSOLUTE MAXIMUM RATINGS (T_A=25°C unless otherwise noted)

Parameter	Symbol	Limit	Unit
Drain-Source Voltage	V _{DS}	20	V
Gate-Source Voltage	V _{GS}	±10	V
Drain Current-Continuous ^a @ T _J =25°C -Pulsed ^b	I _D	6.5	A
	I _{DM}	24	A
Drain-Source Diode Forward Current ^a	I _S	1.25	A
Maximum Power Dissipation ^a	P _D	1.25	W
Operating Junction and Storage Temperature Range	T _J , T _{STG}	-55 to 150	°C

THERMAL CHARACTERISTICS

Thermal Resistance, Junction-to-Ambient ^a	R _{θJA}	100	°C/W
--	------------------	-----	------

STS 2306E

ELECTRICAL CHARACTERISTICS ($T_A = 25^\circ\text{C}$ unless otherwise noted)

Parameter	Symbol	Condition	Min	Typ ^c	Max	Unit
OFF CHARACTERISTICS						
Drain-Source Breakdown Voltage	BV_{DS}	$V_{GS} = 0V, I_D = 250\mu A$	20			V
Zero Gate Voltage Drain Current	I_{DSS}	$V_{DS} = 16V, V_{GS} = 0V$			1	μA
Gate-Body Leakage	I_{GSS}	$V_{GS} = \pm 10V, V_{DS} = 0V$			± 10	μA
ON CHARACTERISTICS^b						
Gate Threshold Voltage	$V_{GS(th)}$	$V_{DS} = V_{GS}, I_D = 250\mu A$	0.5	0.9	1.5	V
Drain-Source On-State Resistance	$R_{DS(ON)}$	$V_{GS} = 4.5V, I_D = 6A$		24	30	m ohm
		$V_{GS} = 2.5V, I_D = 3A$		32	40	m ohm
Forward Transconductance	g_{FS}	$V_{DS} = 7V, I_D = 5A$		16		S
DYNAMIC CHARACTERISTICS^c						
Input Capacitance	C_{ISS}	$V_{DS} = 10V, V_{GS} = 0V$ $f = 1.0MHz$		540		pF
Output Capacitance	C_{OSS}			160		pF
Reverse Transfer Capacitance	C_{RSS}			100		pF
SWITCHING CHARACTERISTICS^c						
Turn-On Delay Time	$t_{D(ON)}$	$V_{DD} = 10V,$ $I_D = 1A,$ $V_{GEN} = 4.5V,$ $R_L = 10\text{ ohm}$ $R_{GEN} = 10\text{ ohm}$		15		ns
Rise Time	t_r			20		ns
Turn-Off Delay Time	$t_{D(OFF)}$			36		ns
Fall Time	t_f			11		ns
Total Gate Charge	Q_g	$V_{DS} = 10V, I_D = 6A, V_{GS} = 4.5V$		6.4		nC
		$V_{DS} = 10V, I_D = 6A, V_{GS} = 2.5V$		4.6		nC
Gate-Source Charge	Q_{gs}	$V_{DS} = 10V, I_D = 6A$		1.1		nC
Gate-Drain Charge	Q_{gd}	$V_{GS} = 4.5V$		2.8		nC

STS 2306E

ELECTRICAL CHARACTERISTICS ($T_A=25^\circ\text{C}$ unless otherwise noted)

Parameter	Symbol	Condition	Min	Typ ^c	Max	Unit
DRAIN-SOURCE DIODE CHARACTERISTICS ^b						
Diode Forward Voltage	V_{SD}	$V_{GS} = 0V, I_s = 1.25A$		0.76	1.2	V

Notes

- a. Surface Mounted on FR4 Board, $t \leq 10\text{sec}$.
- b. Pulse Test: Pulse Width $\leq 300\mu\text{s}$, Duty Cycle $\leq 2\%$.
- c. Guaranteed by design, not subject to production testing.

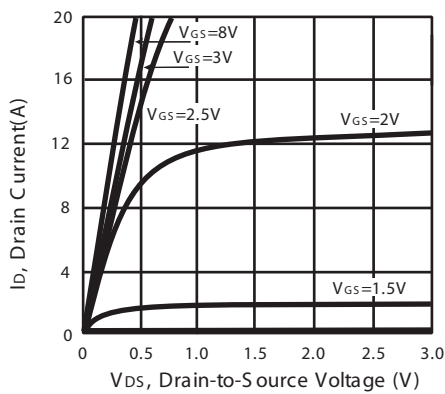

Figure 1. Output Characteristics

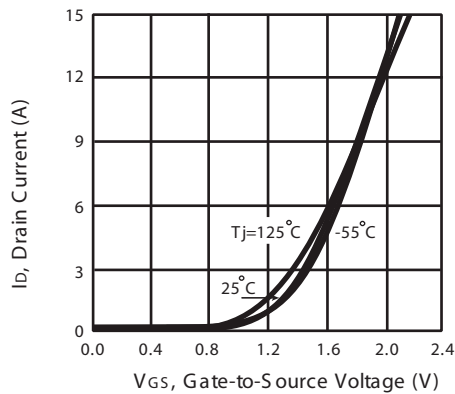

Figure 2. Transfer Characteristics

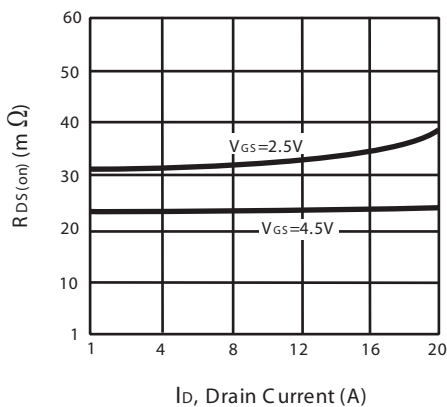

Figure 3. On-Resistance vs. Drain Current and Gate Voltage

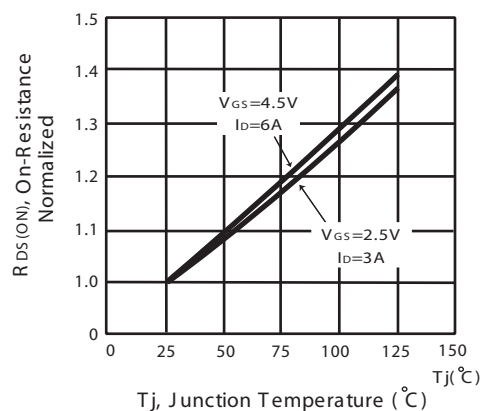

Figure 4. On-Resistance Variation with Drain Current and Temperature

STS 2306E

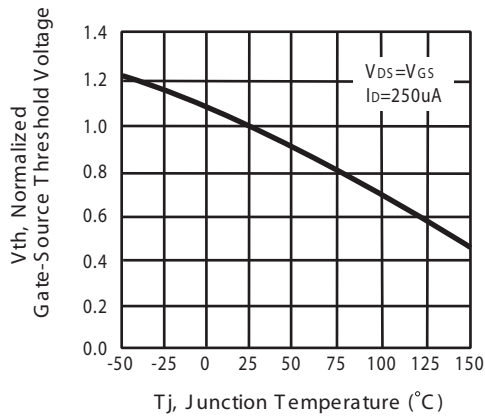

Figure 5. Gate Threshold Variation with Temperature

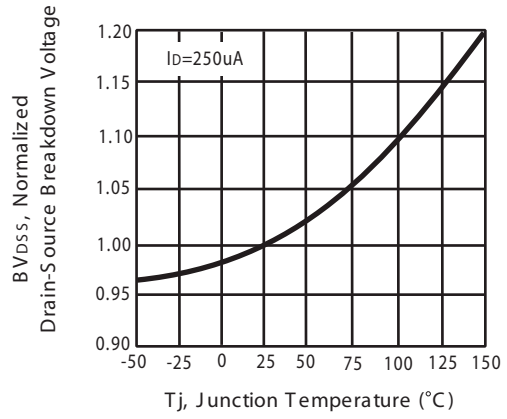

Figure 6. Breakdown Voltage Variation with Temperature

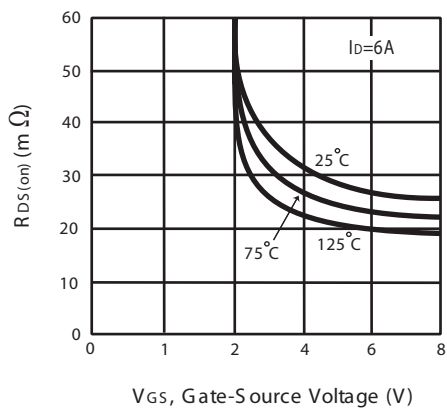

Figure 7. On-Resistance vs. Gate-Source Voltage

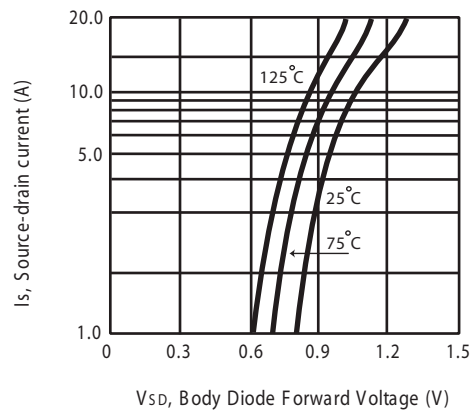

Figure 8. Body Diode Forward Voltage Variation with Source Current

STS 2306E

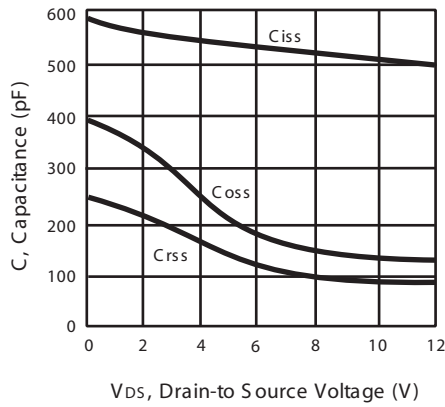

Figure 9. Capacitance

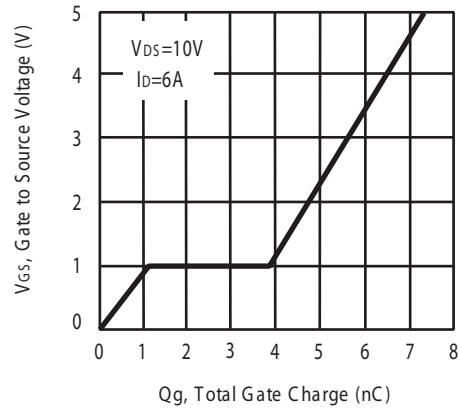

Figure 10. Gate Charge

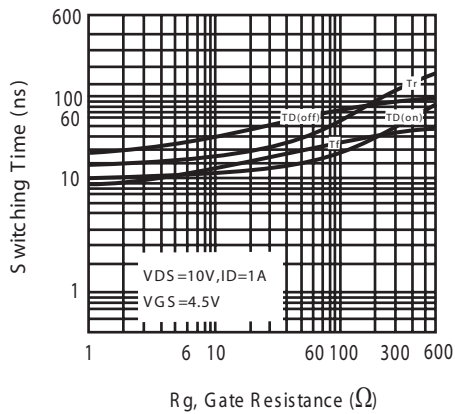

Figure 11. switching characteristics

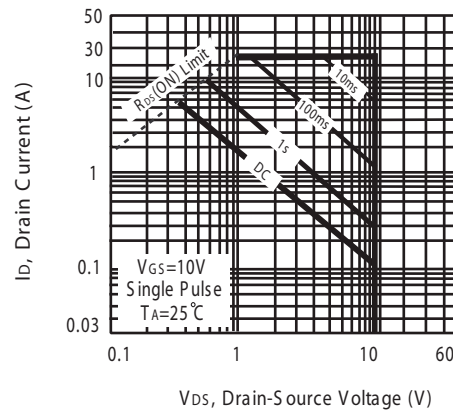
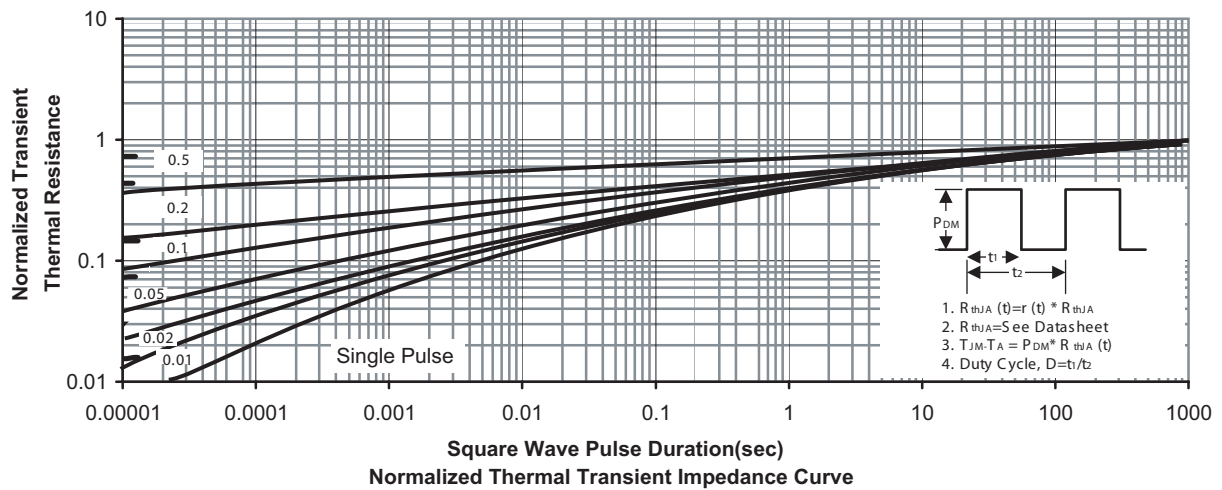

Figure 12. Maximum Safe Operating Area



STS 2306E

PACKAGE OUTLINE DIMENSIONS

SOT-23

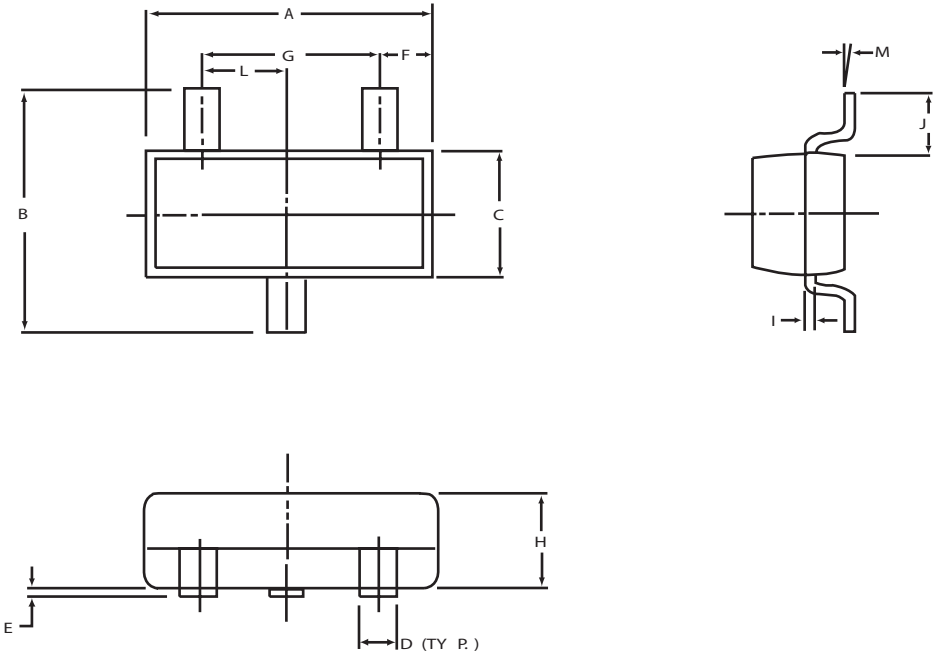

SYMBOLS	MILLIMETERS		INCHES	
	MIN	MAX	MIN	MAX
A	2.70	3.10	0.106	0.122
B	2.40	2.80	0.094	0.110
C	1.40	1.60	0.055	0.063
D	0.35	0.50	0.014	0.020
E	0	0.10	0	0.004
F	0.45	0.55	0.018	0.022
G	1.90 REF.		0.075 REF.	
H	1.00	1.30	0.039	0.051
I	0.10	0.20	0.004	0.008
J	0.40	-	0.016	-
L	0.45	1.15	0.033	0.045
M	0°	10°	0°	10°

STS 2306E

SOT-23 Tape and Reel Data

SOT-23 Carrier Tape

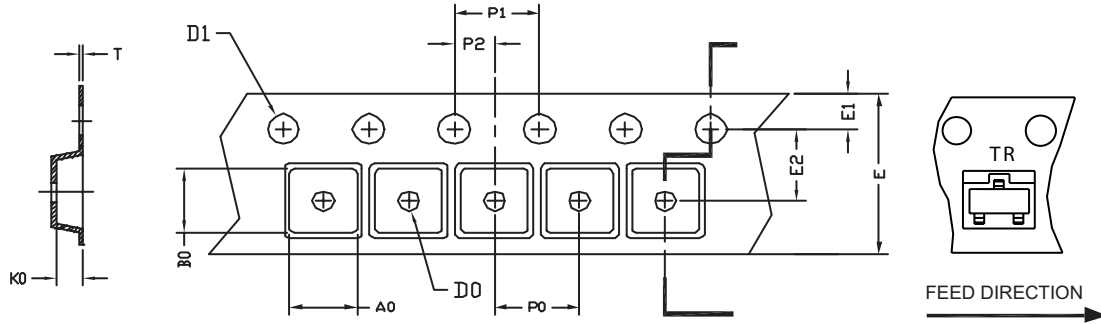

UNIT:mm

PACKAGE	A0	B0	K0	D0	D1	E	E1	E2	P0	P1	P2	T
SOT-23	3.20 ± 0.10	3.00 ± 0.10	1.33 ± 0.10	ϕ 1.00 $+0.25$	ϕ 1.50 $+0.10$	8.00 $+0.30$ -0.10	1.75 ± 0.10	3.50 ± 0.05	4.00 ± 0.10	4.00 ± 0.10	2.00 ± 0.05	0.20 ± 0.02

SOT-23 Reel I

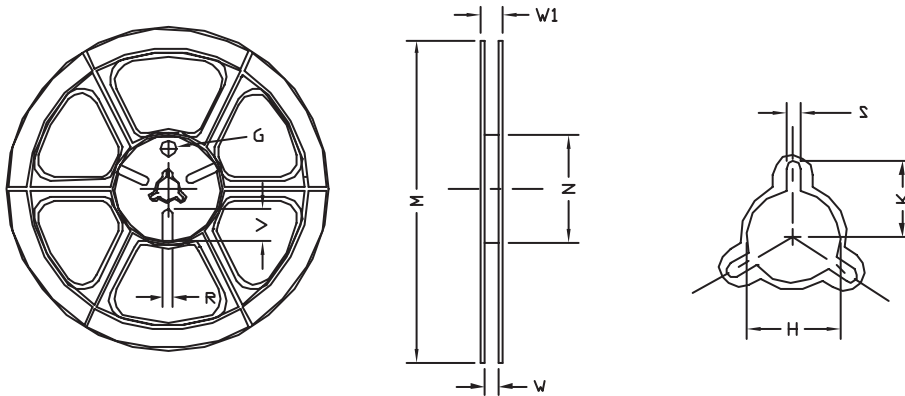

UNIT:mm

TAPE SIZE	REEL SIZE	M	N	W	W1	H	K	S	G	R	V
8mm	ϕ 178	ϕ 178 ± 1	ϕ 60 ± 1	9.00 ± 0.5	12.00 ± 0.5	ϕ 13.5 ± 0.5	10.5	2.00 ± 0.5	ϕ 10.0	5.00	18.00