



N-Channel Enhancement Mode Field Effect Transistor

PRODUCT SUMMARY

V _{DS}	I _D	R _{DS(ON)} (mΩ) Max
30V	2.6A	94 @ V _{GS} =10V
		107 @ V _{GS} =4.5V
		139 @ V _{GS} =2.5V

FEATURES

- Super high dense cell design for low R_{DS(ON)}.
- Rugged and reliable.
- Surface Mount Package.
- ESD Protected.



ABSOLUTE MAXIMUM RATINGS (T_A=25°C unless otherwise noted)

Symbol	Parameter	Limit	Units
V _{DS}	Drain-Source Voltage	30	V
V _{GS}	Gate-Source Voltage	±12	V
I _D	Drain Current-Continuous ^a	T _A =25°C	2.6
		T _A =70°C	2.1
I _{DM}	-Pulsed ^b	9	A
P _D	Maximum Power Dissipation ^a	T _A =25°C	1.25
		T _A =70°C	0.8
T _J , T _{STG}	Operating Junction and Storage Temperature Range	-55 to 150	°C

THERMAL CHARACTERISTICS

Symbol	Parameter	Limit	Units
R _{θJA}	Thermal Resistance, Junction-to-Ambient ^a	100	°C/W

STS3116E

Ver 1.1

ELECTRICAL CHARACTERISTICS (T_A=25°C unless otherwise noted)

Symbol	Parameter	Conditions	Min	Typ	Max	Units
OFF CHARACTERISTICS						
BV _{DSS}	Drain-Source Breakdown Voltage	V _{GS} =0V, I _D =250uA	30			V
I _{DSS}	Zero Gate Voltage Drain Current	V _{DS} =24V, V _{GS} =0V			1	uA
I _{GSS}	Gate-Body Leakage Current	V _{GS} = ±12V, V _{DS} =0V			±10	uA
ON CHARACTERISTICS						
V _{GS(th)}	Gate Threshold Voltage	V _{DS} =V _{GS} , I _D =250uA	0.5	0.9	1.5	V
R _{DS(ON)}	Drain-Source On-State Resistance	V _{GS} =10V, I _D =1.3A		75	94	m ohm
		V _{GS} =4.5V, I _D =1.2A		82	107	m ohm
		V _{GS} =2.5V, I _D =1A		103	139	m ohm
g _{FS}	Forward Transconductance	V _{DS} =5V, I _D =1.3A		6.5		S
DYNAMIC CHARACTERISTICS ^c						
C _{ISS}	Input Capacitance	V _{DS} =15V, V _{GS} =0V f=1.0MHz		396		pF
C _{OSS}	Output Capacitance			56		pF
C _{RSS}	Reverse Transfer Capacitance			33		pF
SWITCHING CHARACTERISTICS ^c						
t _{D(ON)}	Turn-On Delay Time	V _{DD} =15V I _D =1A		46		ns
t _r	Rise Time			77		ns
t _{D(OFF)}	Turn-Off Delay Time	V _{GS} =10V		413		ns
t _f	Fall Time	R _{GEN} = 6 ohm		48		ns
Q _g	Total Gate Charge	V _{DS} =15V, I _D =1.3A, V _{GS} =10V		3.8		nC
Q _{gs}	Gate-Source Charge	V _{DS} =15V, I _D =1.3A, V _{GS} =10V		0.6		nC
Q _{gd}	Gate-Drain Charge			1.3		nC
DRAIN-SOURCE DIODE CHARACTERISTICS						
V _{SD}	Diode Forward Voltage ^b	V _{GS} =0V, I _S = 1A		0.82	1.2	V

Notes

- a. Surface Mounted on FR4 Board, t ≤ 10sec.
- b. Pulse Test: Pulse Width ≤ 300us, Duty Cycle ≤ 2%.
- c. Guaranteed by design, not subject to production testing.

Jan,08,2014

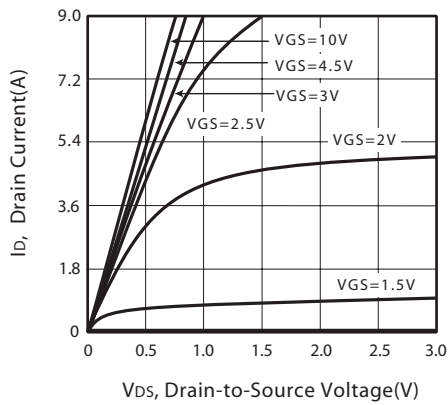

Figure 1. Output Characteristics

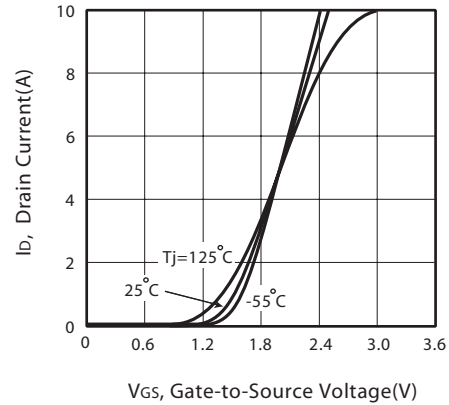

Figure 2. Transfer Characteristics

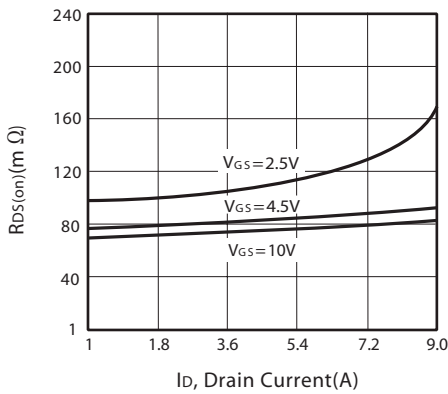

Figure 3. On-Resistance vs. Drain Current and Gate Voltage

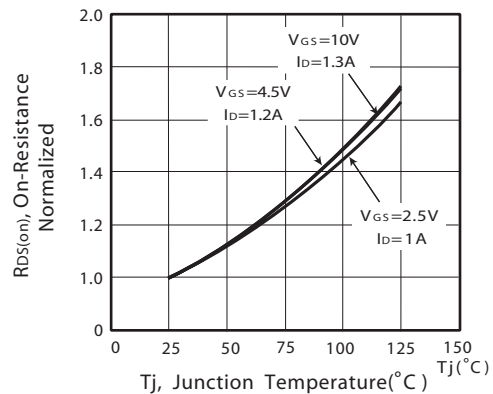

Figure 4. On-Resistance Variation with Drain Current and Temperature

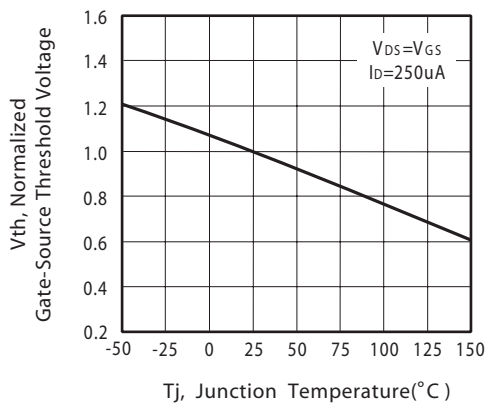

Figure 5. Gate Threshold Variation with Temperature

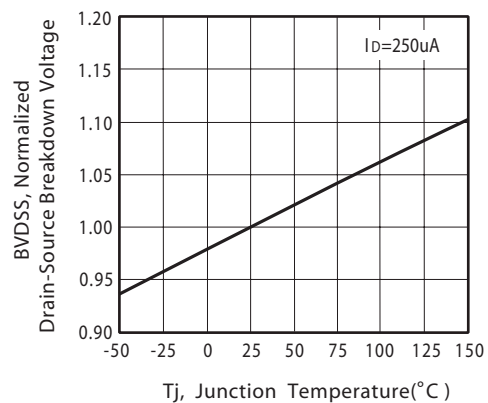

Figure 6. Breakdown Voltage Variation with Temperature

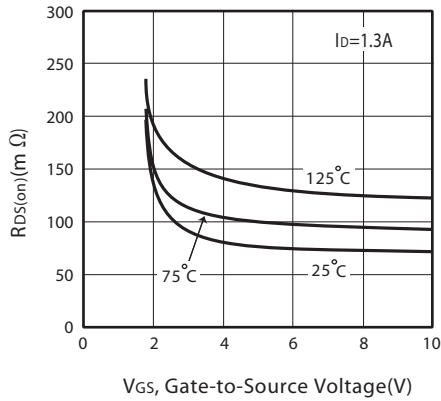

Figure 7. On-Resistance vs. Gate-Source Voltage

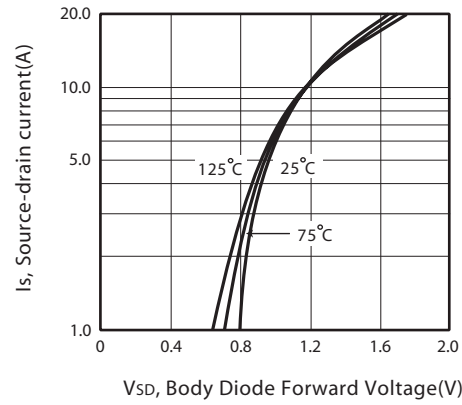

Figure 8. Body Diode Forward Voltage Variation with Source Current

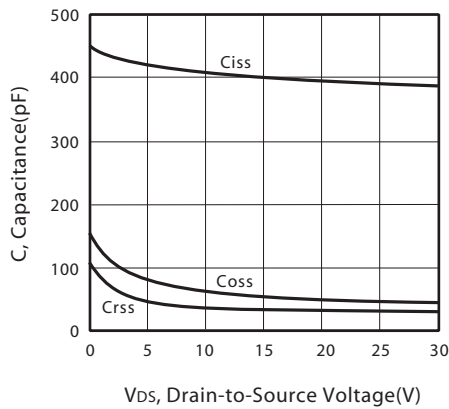

Figure 9. Capacitance

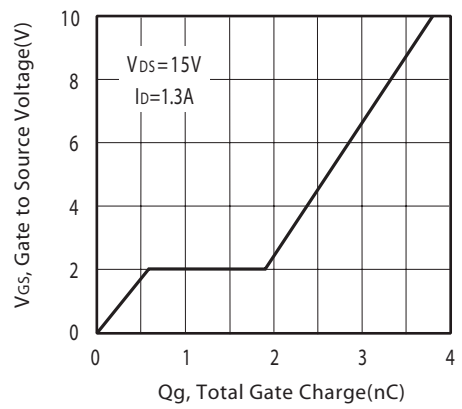

Figure 10. Gate Charge

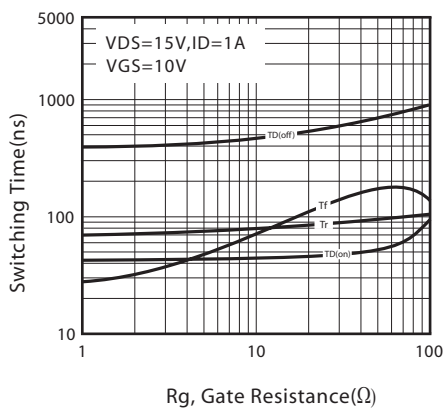

Figure 11. switching characteristics

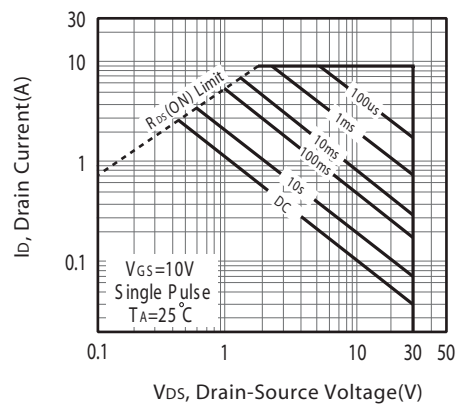

Figure 12. Maximum Safe Operating Area

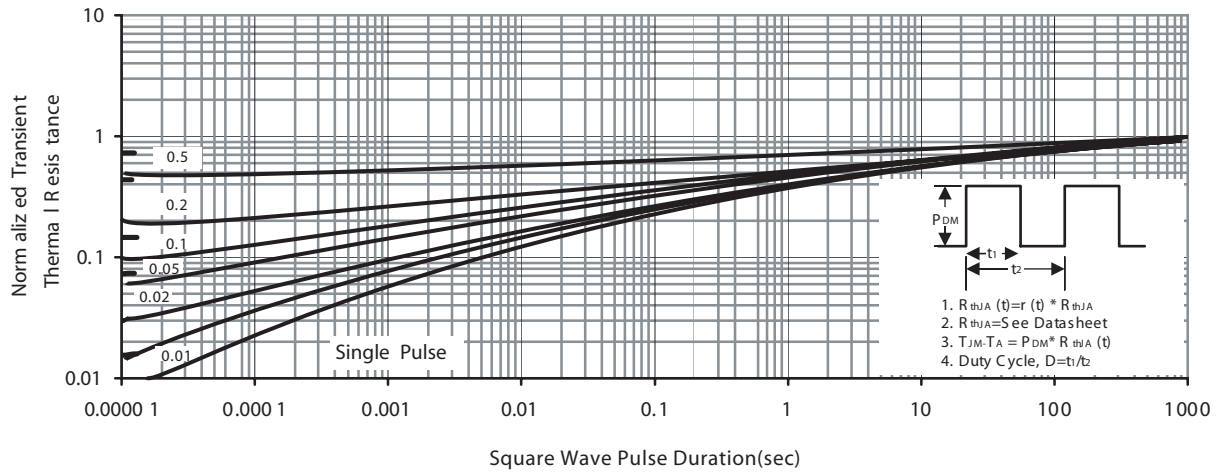
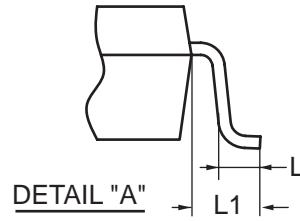
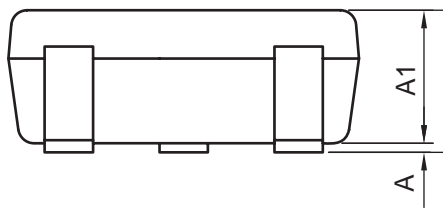
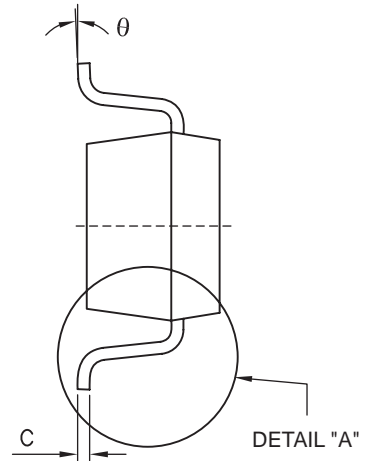
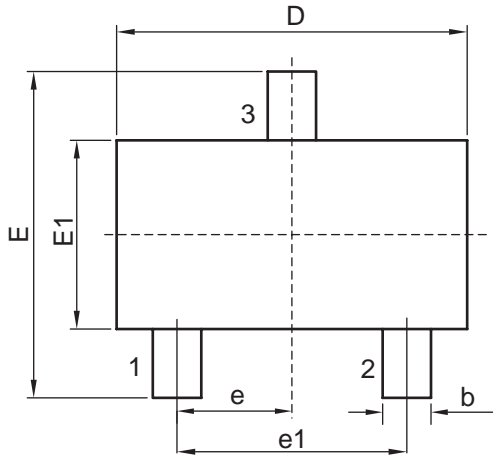

Figure 13. Normalized Thermal Transient Impedance Curve

PACKAGE OUTLINE DIMENSIONS

SOT 23



SYMBOLS	MILLIMETERS		INCHES	
	MIN	MAX	MIN	MAX
D	2.700	3.100	0.106	0.122
E	2.200	3.000	0.087	0.118
E1	1.200	1.700	0.047	0.067
e	0.850	1.150	0.033	0.045
e1	1.800	2.100	0.071	0.083
b	0.300	0.510	0.019	0.020
C	0.080	0.200	0.003	0.008
A	0.000	0.150	0.000	0.006
A1	0.887	1.300	0.035	0.051
L	0.450 REF.		0.018 REF.	
L1	0.600 REF.		0.024 REF.	
θ	0°	10°	0°	10°

SOT23 Tape and Reel Data

SOT23-3L Carrier Tape

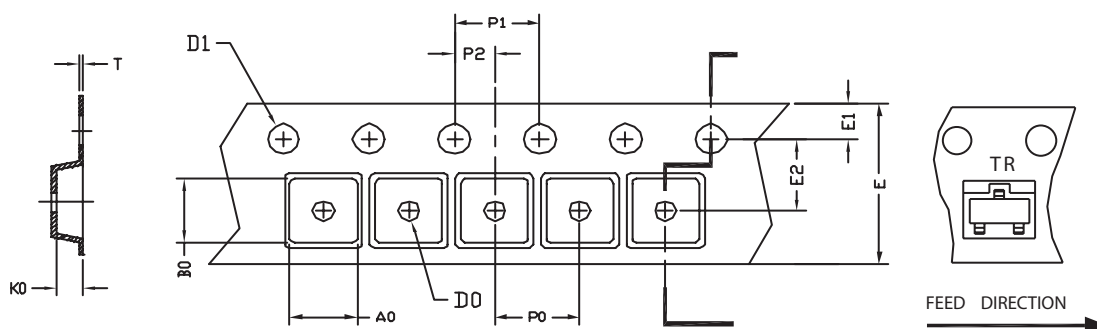

UNIT:mm

PACKAGE	A0	B0	K0	D0	D1	E	E1	E2	P0	P1	P2	T
SOT23-3L	3.15 ± 0.10	2.77 ± 0.10	1.22 ± 0.10	ϕ 1.00 $+0.05$	ϕ 1.50 $+0.10$	8.00 $+0.30$ -0.10	1.75 ± 0.10	3.50 ± 0.05	4.00 ± 0.10	4.00 ± 0.10	2.00 ± 0.05	0.22 ± 0.04

SOT23-3L Reel

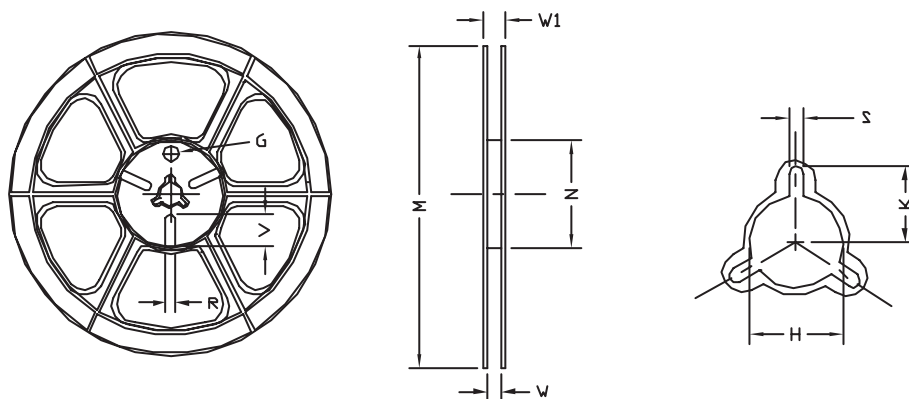

UNIT:mm

TAPE SIZE	REEL SIZE	M	N	W	W1	H	K	S	G	R	V
8mm	ϕ 178	ϕ 178 ± 1	ϕ 60 ± 1	9.00 ± 0.5	12.00 ± 0.5	ϕ 13.5 ± 0.5	10.5	2.00 ± 0.5	ϕ 10.0	5.00	18.00

TOP MARKING DEFINITION

