



N-Channel Logic Level Enhancement Mode Field Effect Transistor

PRODUCT SUMMARY

| V _{DSS} | I _D | R _{DS(ON)} (mΩ) Max |
|------------------|----------------|------------------------------|
| 100V | 1.5A | 310 @ V _{GS} =10V |
| | | 350 @ V _{GS} =4.5V |

FEATURES

- Super high dense cell design for low R_{DS(ON)}.
- Rugged and reliable.
- Surface Mount Package.



ABSOLUTE MAXIMUM RATINGS (T_A=25°C unless otherwise noted)

| Symbol | Parameter | Limit | Units |
|-----------------------------------|--|----------------------|-------|
| V _{DS} | Drain-Source Voltage | 100 | V |
| V _{GS} | Gate-Source Voltage | ±20 | V |
| I _D | Drain Current-Continuous ^{a d} | T _A =25°C | 1.5 |
| | | T _A =70°C | 1.2 |
| I _{DM} | -Pulsed ^b | 10 | A |
| P _D | Maximum Power Dissipation ^a | T _A =25°C | 3 |
| | | T _A =70°C | 1.9 |
| T _J , T _{STG} | Operating Junction and Storage Temperature Range | -55 to 150 | °C |

THERMAL CHARACTERISTICS

| | | | |
|------------------|--|----|------|
| R _{θJA} | Thermal Resistance, Junction-to-Ambient ^a | 42 | °C/W |
|------------------|--|----|------|

STT01L10

Ver 1.0

ELECTRICAL CHARACTERISTICS (T_A=25°C unless otherwise noted)

| Symbol | Parameter | Conditions | Min | Typ | Max | Units |
|---|----------------------------------|---|---|------|------|-------|
| OFF CHARACTERISTICS | | | | | | |
| BV _{DSS} | Drain-Source Breakdown Voltage | V _{GS} =0V , I _D =250uA | 100 | | | V |
| I _{DSS} | Zero Gate Voltage Drain Current | V _{DS} =80V , V _{GS} =0V | | | 1 | uA |
| I _{GSS} | Gate-Body Leakage Current | V _{GS} = ±20V , V _{DS} =0V | | | ±100 | nA |
| ON CHARACTERISTICS | | | | | | |
| V _{GS(th)} | Gate Threshold Voltage | V _{DS} =V _{GS} , I _D =250uA | 1 | 1.7 | 3 | V |
| R _{DS(ON)} | Drain-Source On-State Resistance | V _{GS} =10V , I _D =0.75A | | 230 | 310 | m ohm |
| | | V _{GS} =4.5V , I _D =0.7A | | 260 | 350 | m ohm |
| g _{FS} | Forward Transconductance | V _{DS} =10V , I _D =0.75A | | 5.5 | | S |
| DYNAMIC CHARACTERISTICS ^c | | | | | | |
| C _{ISS} | Input Capacitance | V _{DS} =25V, V _{GS} =0V f=1.0MHz | | 480 | | pF |
| C _{OSS} | Output Capacitance | | | 28 | | pF |
| C _{RSS} | Reverse Transfer Capacitance | | | 20 | | pF |
| SWITCHING CHARACTERISTICS ^c | | | | | | |
| t _{D(ON)} | Turn-On Delay Time | V _{DD} =50V I _D =0.75A V _{GS} =10V R _{GEN} = 6 ohm | | 9.3 | | ns |
| t _r | Rise Time | | | 8.2 | | ns |
| t _{D(OFF)} | Turn-Off Delay Time | | | 19.2 | | ns |
| t _f | Fall Time | | | 9.2 | | ns |
| Q _g | Total Gate Charge | | V _{DS} =50V, I _D =0.75A, V _{GS} =10V | | 8 | |
| | | V _{DS} =50V, I _D =0.75A, V _{GS} =4.5V | | 4.2 | | nC |
| Q _{gs} | Gate-Source Charge | V _{DS} =50V, I _D =0.75A, | | 1 | | nC |
| Q _{gd} | Gate-Drain Charge | V _{GS} =10V | | 1.8 | | nC |
| DRAIN-SOURCE DIODE CHARACTERISTICS AND MAXIMUM RATINGS | | | | | | |
| V _{SD} | Diode Forward Voltage | V _{GS} =0V, I _S =0.9A | | 0.8 | 1.2 | V |
| Notes | | | | | | |
| a.Surface Mounted on FR4 Board,t ≤ 10sec. | | | | | | |
| b.Pulse Test:Pulse Width ≤ 300us, Duty Cycle ≤ 2%. | | | | | | |
| c.Guaranteed by design, not subject to production testing. | | | | | | |
| d.Drain current limited by maximum junction temperature. | | | | | | |

Aug,28,2013

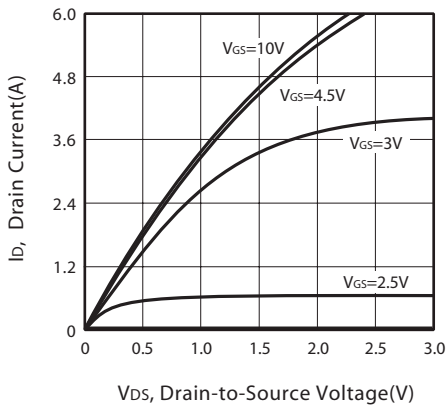

Figure 1. Output Characteristics

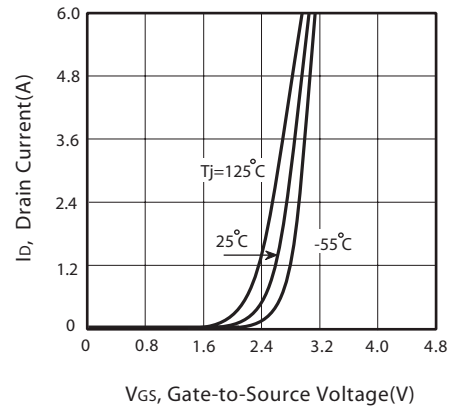

Figure 2. Transfer Characteristics

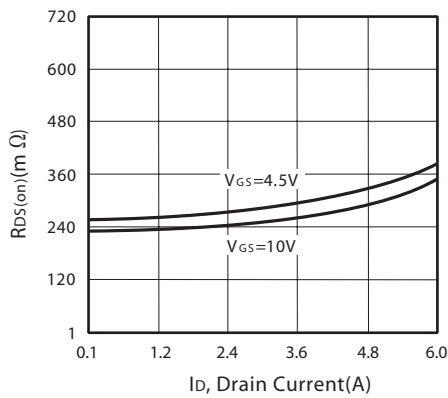

Figure 3. On-Resistance vs. Drain Current and Gate Voltage

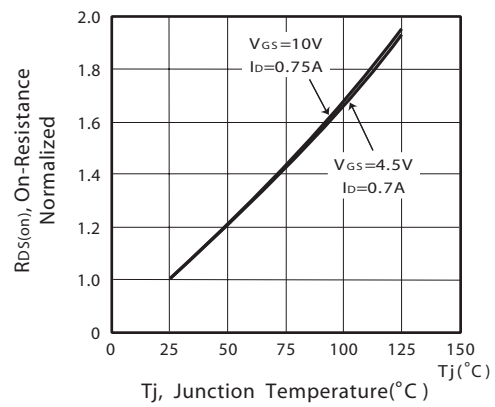

Figure 4. On-Resistance Variation with Drain Current and Temperature

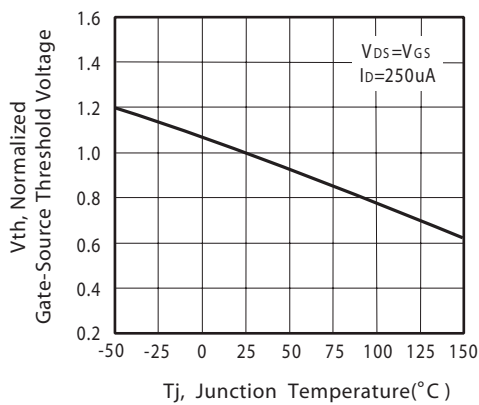

Figure 5. Gate Threshold Variation with Temperature

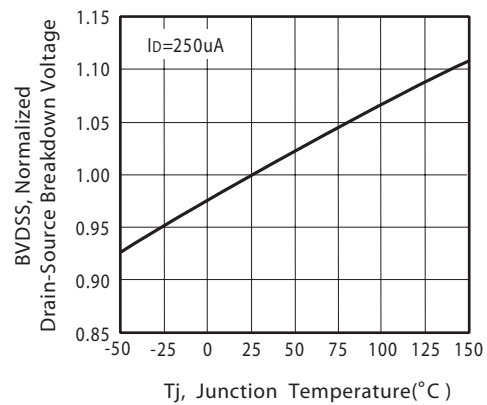

Figure 6. Breakdown Voltage Variation with Temperature

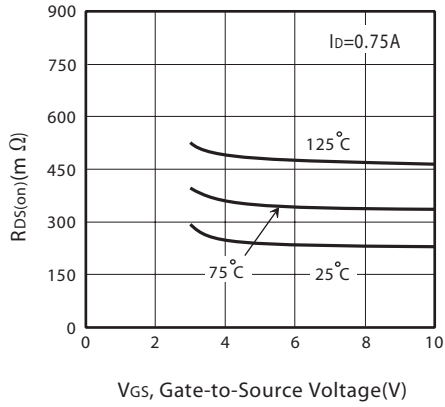

Figure 7. On-Resistance vs. Gate-Source Voltage

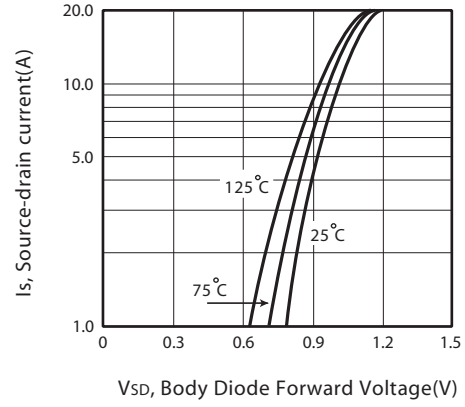

Figure 8. Body Diode Forward Voltage Variation with Source Current

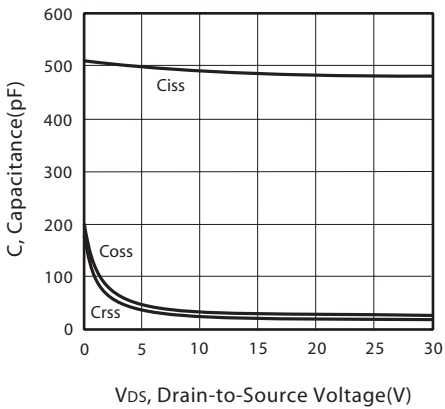

Figure 9. Capacitance

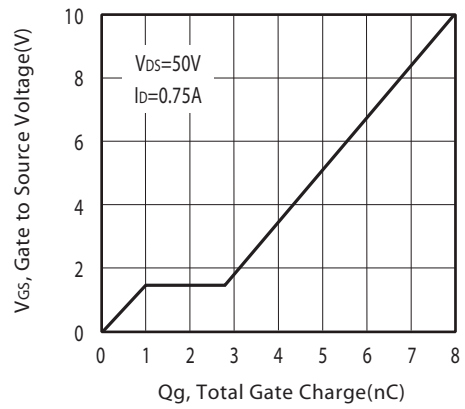

Figure 10. Gate Charge

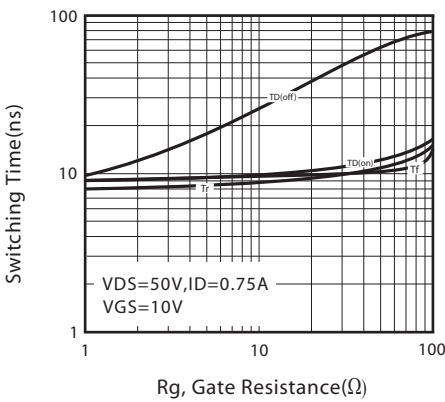

Figure 11. switching characteristics

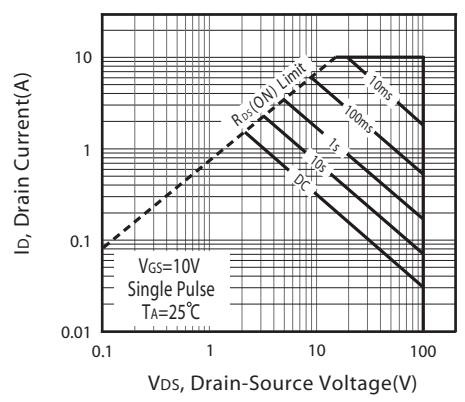

Figure 12. Maximum Safe Operating Area

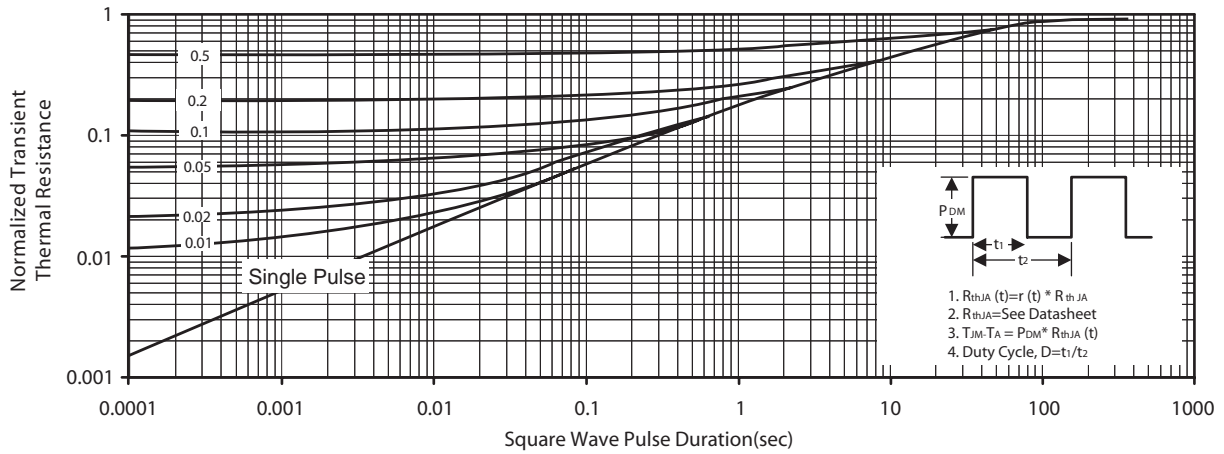
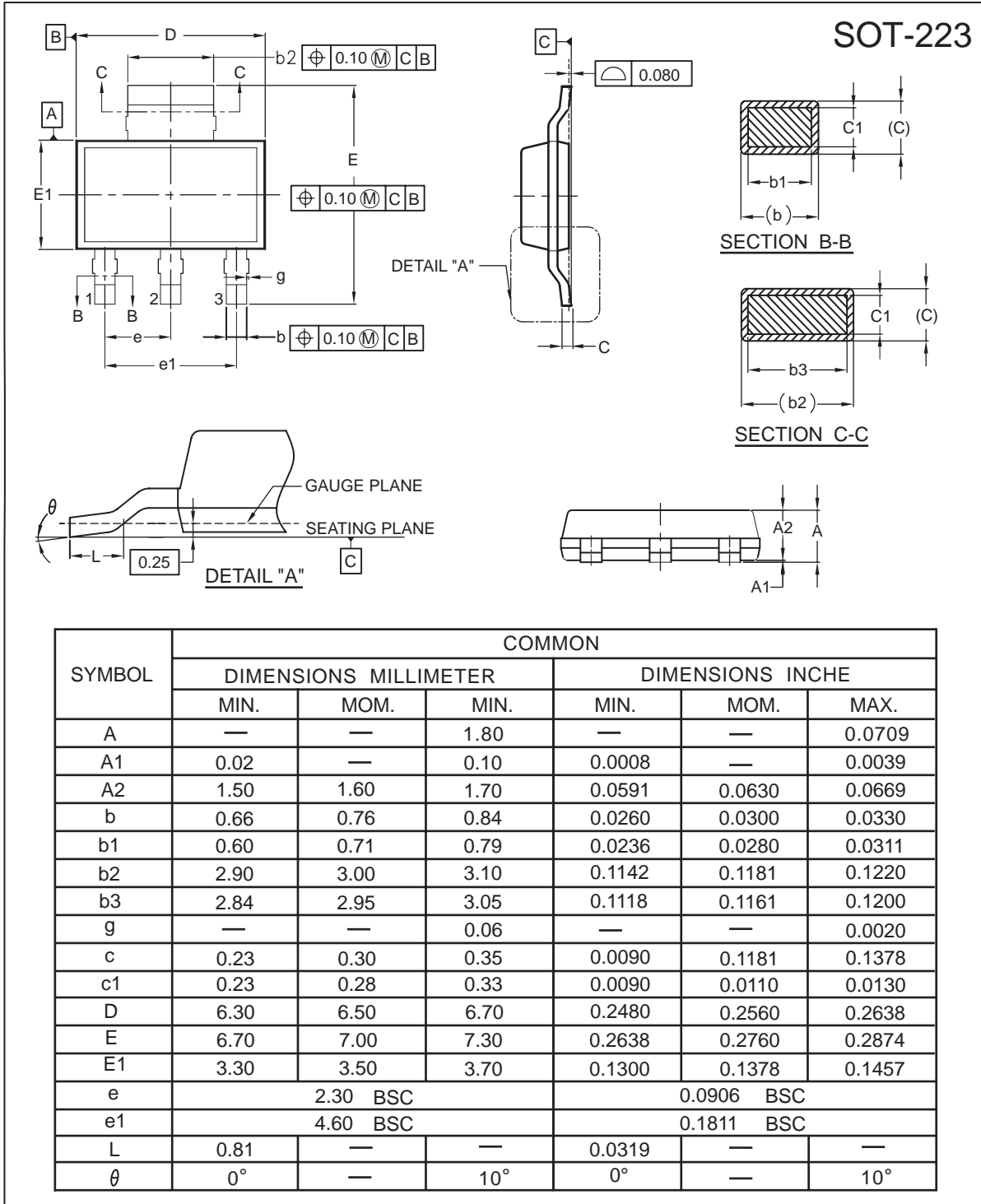

Figure 13. Normalized Thermal Transient Impedance Curve

STT01L10

Ver 1.0



Aug,28,2013

SOT-223 Tape and Reel Data

SOT-223 Carrier Tape

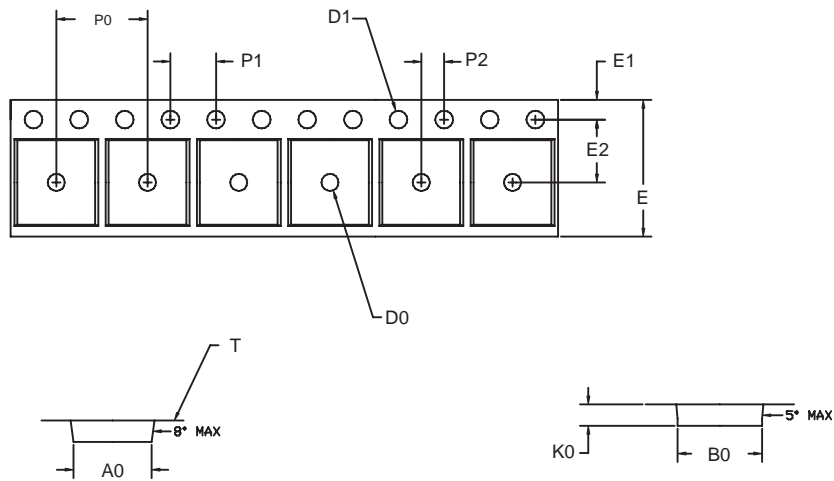

unit:mm

| PACKAGE | A0 | B0 | K0 | D0 | D1 | E | E1 | E2 | P0 | P1 | P2 | T |
|---------|--------------|--------------|--------------|---------------|--------------|----------------------|--------------|--------------|-------------|--------------|---------------|----------------|
| --- | 6.83 ±0.1 | 7.42 ±0.1 | 1.88 ±0.1 | 1.50 +0.25 | 1.60 +0.1 | 12.0 +0.3 -0.1 | 1.75 ±0.1 | 5.50 ±0.5 | 8.0 ±0.1 | 4.00 ±0.1 | 2.00 ±0.05 | 0.292 ±0.02 |

SOT-223 Reel

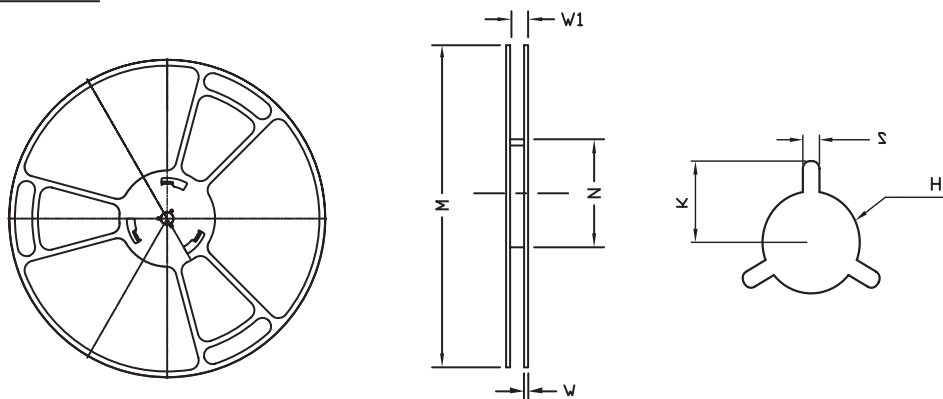

UNIT:mm

| REEL SIZE | M | N | W | W1 | H | K | S | G | R | V |
|----------------|-----|-----------------|-----|---------------|--------------------------|------|--------------|-----|-----|-----|
| φ 330 ± 0.5 | --- | φ 97.0 ± 1.0 | 2.2 | 13.0 + 1.5 | φ 13.0 + 0.5 - 0.2 | 10.6 | 2.0 ± 0.5 | --- | --- | --- |

STT01L10

TOP MARKING DEFINITION

