



N-Channel Logic Level Enhancement Mode Field Effect Transistor

PRODUCT SUMMARY

VDSS	ID	RDS(ON) (mΩ) Max
30V	55A	5.6 @ VGS=10V
		9 @ VGS=4.5V

FEATURES

- Super high dense cell design for low $R_{DS(ON)}$.
- Rugged and reliable.
- TO-252 and TO-251 Package.

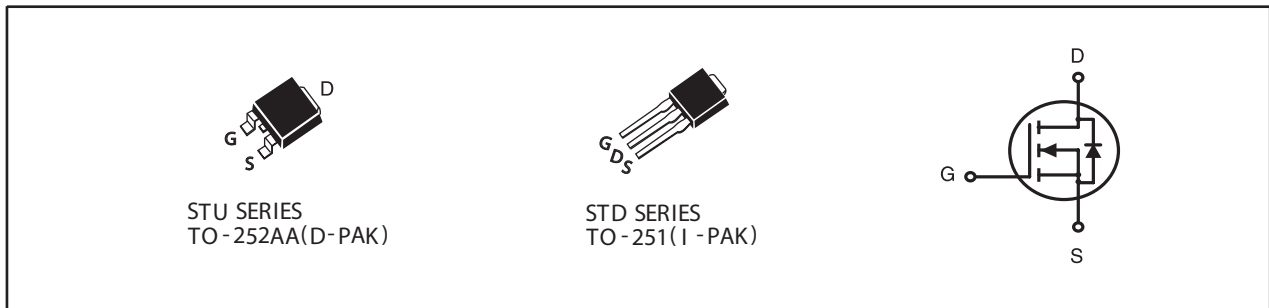

ABSOLUTE MAXIMUM RATINGS ($T_C=25^\circ\text{C}$ unless otherwise noted)

Symbol	Parameter	Limit	Units
V_{DS}	Drain-Source Voltage	30	V
V_{GS}	Gate-Source Voltage	± 20	V
I_D	Drain Current-Continuous	$T_C=25^\circ\text{C}$	55
		$T_C=70^\circ\text{C}$	44
I_{DM}	-Pulsed ^a	161	A
E_{AS}	Single Pulse Avalanche Energy ^c	132	mJ
P_D	Maximum Power Dissipation	$T_C=25^\circ\text{C}$	42
		$T_C=70^\circ\text{C}$	27
T_J, T_{STG}	Operating Junction and Storage Temperature Range	-55 to 150	$^\circ\text{C}$

THERMAL CHARACTERISTICS

$R_{\theta JC}$	Thermal Resistance, Junction-to-Case	3	$^\circ\text{C/W}$
$R_{\theta JA}$	Thermal Resistance, Junction-to-Ambient	50	$^\circ\text{C/W}$

STU/D336S

Ver 1.0

ELECTRICAL CHARACTERISTICS (T_C=25°C unless otherwise noted)

Symbol	Parameter	Conditions	Min	Typ	Max	Units
OFF CHARACTERISTICS						
BV _{DSS}	Drain-Source Breakdown Voltage	V _{GS} =0V , I _D =250uA	30			V
I _{DSS}	Zero Gate Voltage Drain Current	V _{DS} =24V , V _{GS} =0V			1	uA
I _{GSS}	Gate-Body Leakage Current	V _{GS} = ±20V , V _{DS} =0V			±100	nA
ON CHARACTERISTICS						
V _{GS(th)}	Gate Threshold Voltage	V _{DS} =V _{GS} , I _D =250uA	1.0	1.6	3	V
R _{DS(ON)}	Drain-Source On-State Resistance	V _{GS} =10V , I _D =27.5A		4.5	5.6	m ohm
		V _{GS} =4.5V , I _D =22A		6.6	9.0	m ohm
g _{FS}	Forward Transconductance	V _{DS} =10V , I _D =27.5A		65		S
DYNAMIC CHARACTERISTICS^b						
C _{ISS}	Input Capacitance	V _{DS} =15V, V _{GS} =0V f=1.0MHz		1550		pF
C _{OSS}	Output Capacitance			242		pF
C _{RSS}	Reverse Transfer Capacitance			204		pF
SWITCHING CHARACTERISTICS^b						
t _{D(ON)}	Turn-On Delay Time	V _{DD} =15V I _D =1A V _{GS} =10V R _{GEN} = 6 ohm		25		ns
t _r	Rise Time			32		ns
t _{D(OFF)}	Turn-Off Delay Time			70		ns
t _f	Fall Time			26		ns
Q _g	Total Gate Charge	V _{DS} =15V, I _D =27.5A, V _{GS} =10V		23		nC
		V _{DS} =15V, I _D =27.5A, V _{GS} =4.5V		11		nC
Q _{gs}	Gate-Source Charge	V _{DS} =15V, I _D =27.5A, V _{GS} =10V		2.3		nC
Q _{gd}	Gate-Drain Charge			7.1		nC
DRAIN-SOURCE DIODE CHARACTERISTICS AND MAXIMUM RATINGS						
V _{SD}	Diode Forward Voltage	V _{GS} =0V, I _S =5A		0.79	1.3	V

Notes

- a. Pulse Test: Pulse Width ≤ 300us, Duty Cycle ≤ 2%.
 b. Guaranteed by design, not subject to production testing.
 c. Starting T_J=25°C, L=0.5mH, V_{DD} = 20V. (See Figure13)

Jul, 18, 2012

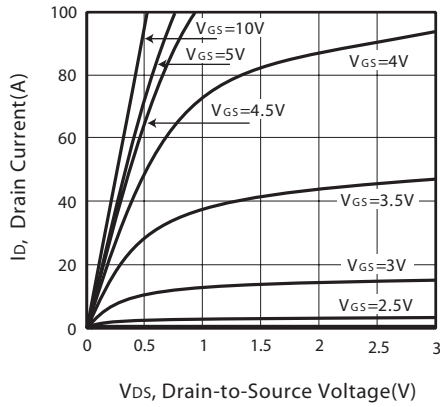

Figure 1. Output Characteristics

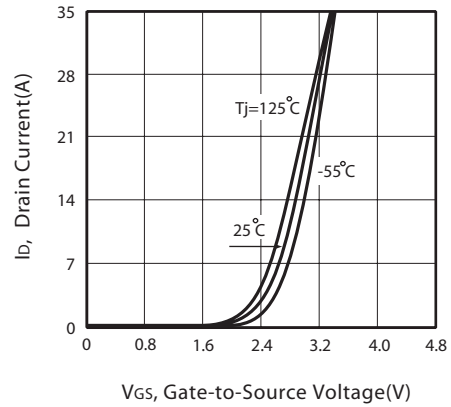

Figure 2. Transfer Characteristics

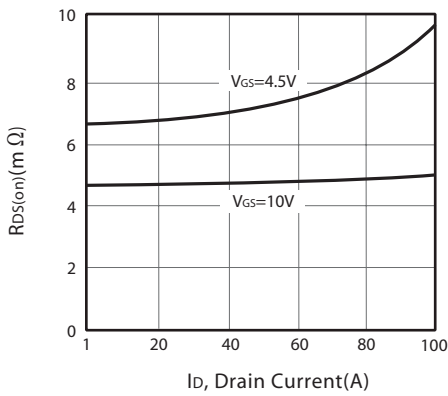

Figure 3. On-Resistance vs. Drain Current and Gate Voltage

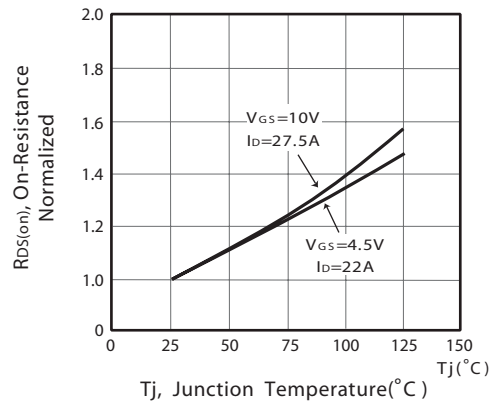

Figure 4. On-Resistance Variation with Drain Current and Temperature

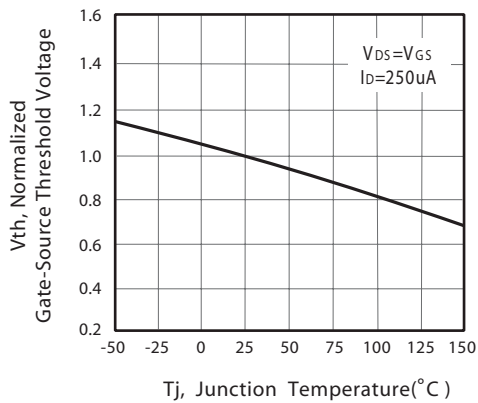

Figure 5. Gate Threshold Variation with Temperature

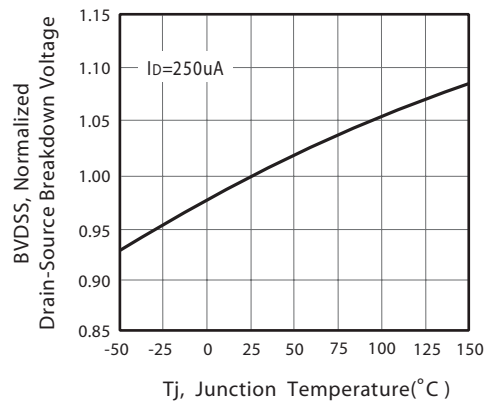

Figure 6. Breakdown Voltage Variation with Temperature

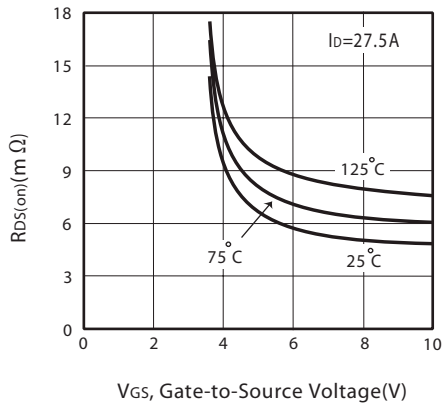

Figure 7. On-Resistance vs. Gate-Source Voltage

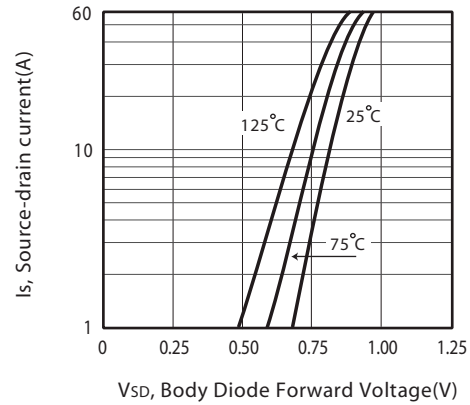

Figure 8. Body Diode Forward Voltage Variation with Source Current

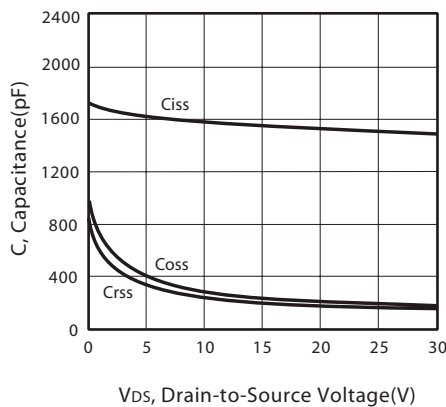

Figure 9. Capacitance

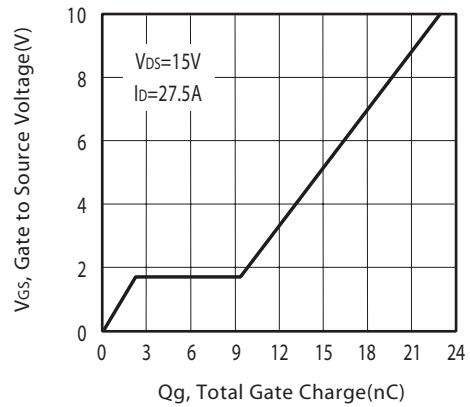

Figure 10. Gate Charge

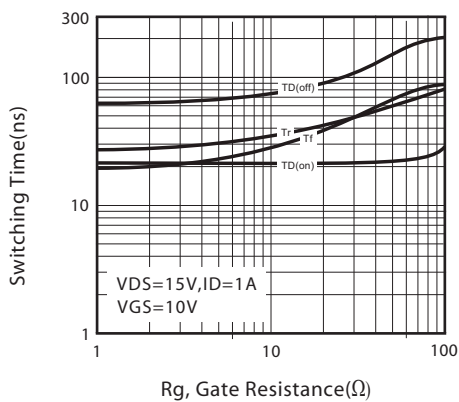

Figure 11. switching characteristics

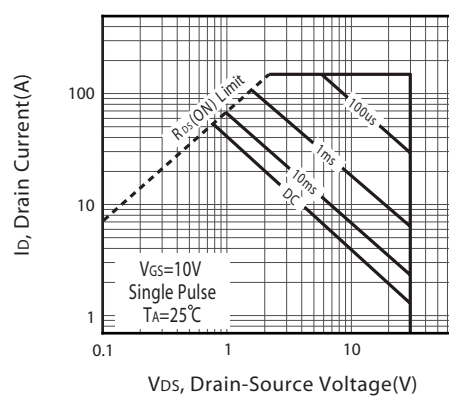
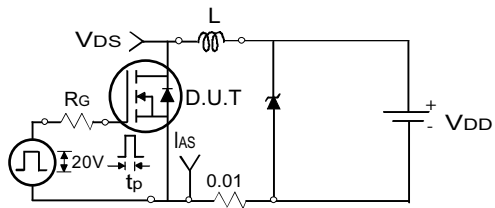
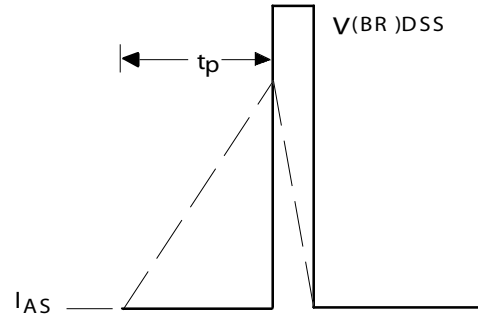

Figure 12. Maximum Safe Operating Area



Uncamped Inductive Test Circuit

Figure 13a.



Uncamped Inductive Waveforms

Figure 13b.

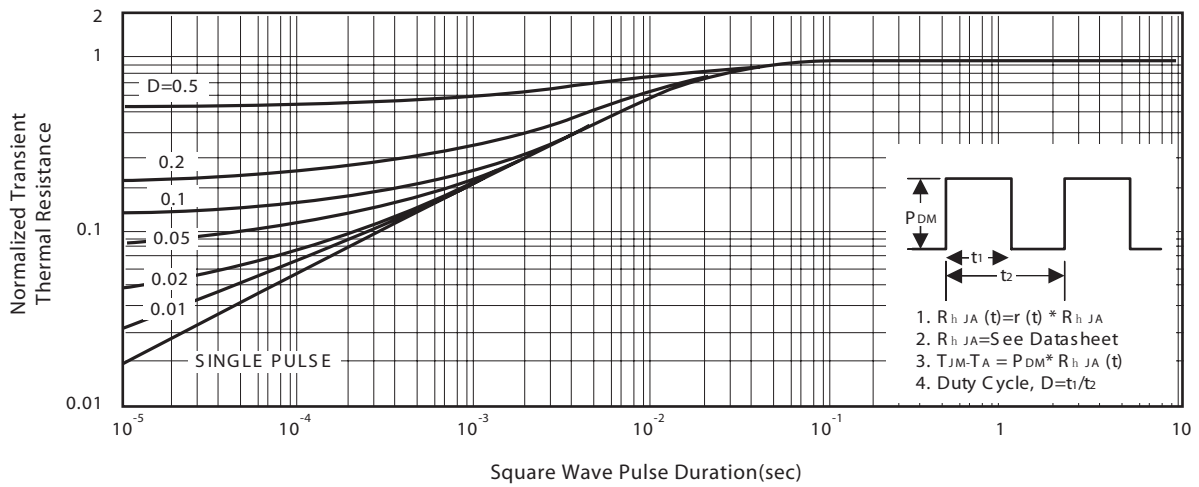
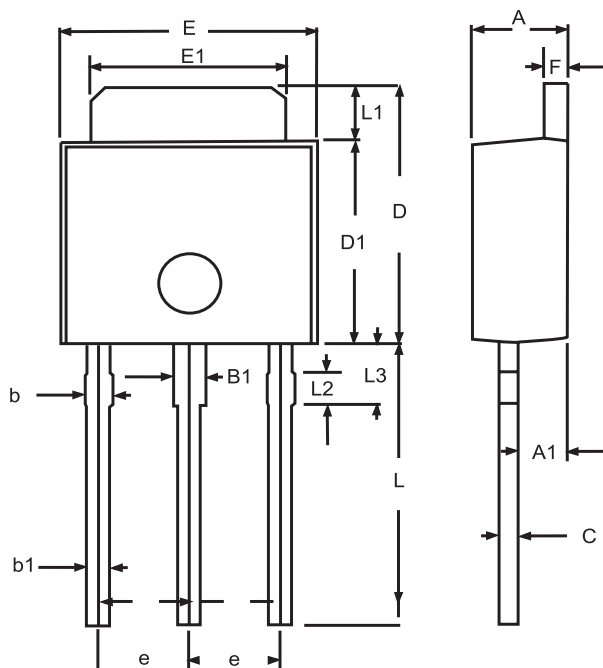

Figure 14. Normalized Thermal Transient Impedance Curve

PACKAGE OUTLINE DIMENSIONS

TO-251



SYMBOLS	MILLIMETERS		INCHES	
	MIN	MAX	MIN	MAX
A	2.20	2.40	0.087	0.095
A1	1.100	1.300	0.043	0.051
B1	0.650	1.050	0.026	0.041
b	0.500	0.900	0.020	0.035
b1	0.400	0.800	0.016	0.32
C	0.400	0.600	0.016	0.024
D	6.700	7.300	0.264	0.287
D1	5.400	5.650	0.213	0.222
E	6.40	6.650	0.252	0.262
e	2.100	2.500	0.083	0.098
F	0.400	0.600	0.016	0.024
L	7.000	8.000	0.276	0.315
L1	1.300	1.700	0.051	0.067
L2	0.700	0.900	0.028	0.035
L3	1.400	1.800	0.055	0.071

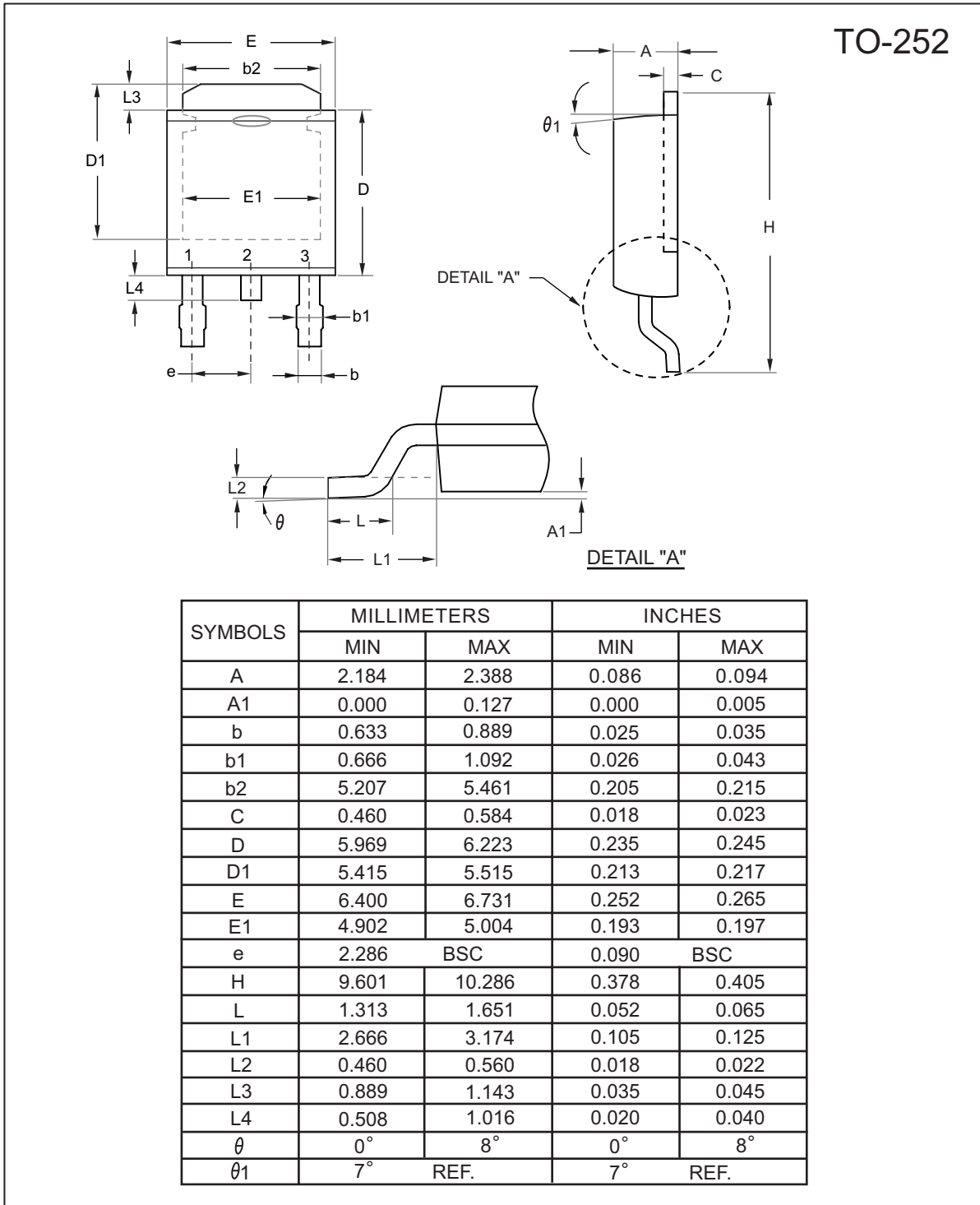

TO-251 Tube/TO-252 Tape and Reel Data

TO-251 Tube

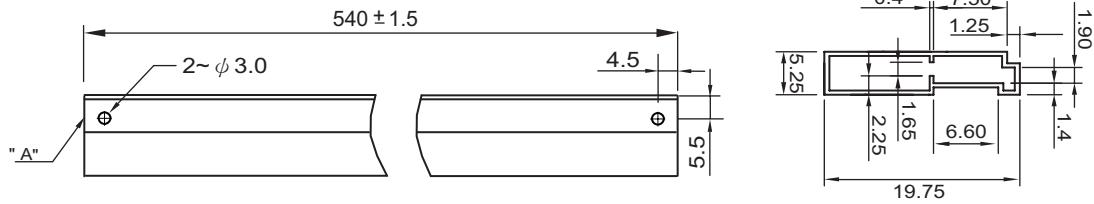

TO-252 Carrier Tape

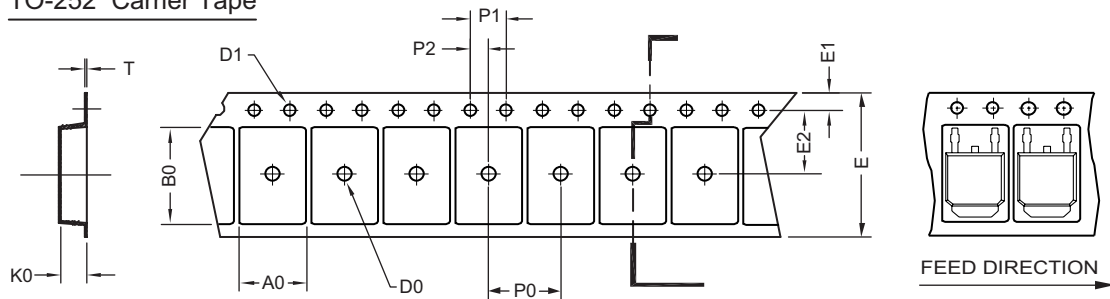

UNIT:mm

PACKAGE	A0	B0	K0	D0	D1	E	E1	E2	P0	P1	P2	T
TO-252 (16 mm)	6.96 ±0.1	10.49 ±0.1	2.79 ±0.1	φ 2	φ 1.5 + 0.1 - 0	16.0 ±0.3	1.75 ±0.1	7.5 ±0.15	8.0 ±0.1	4.0 ±0.1	2.0 ±0.15	0.3 ±0.05

TO-252 Reel

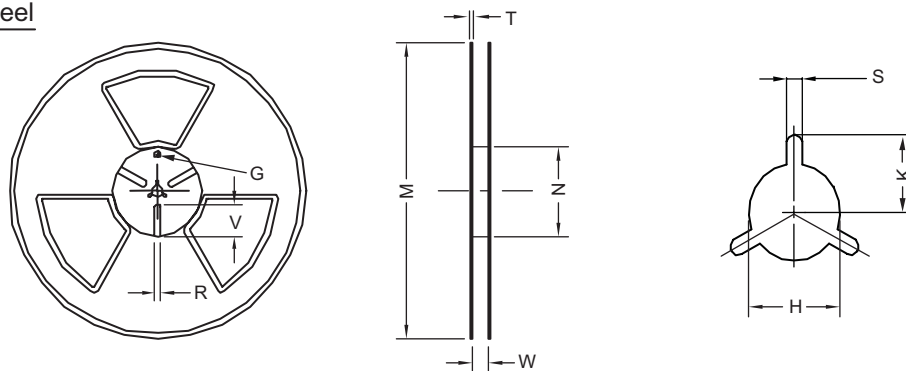

UNIT:mm

TAPE SIZE	REEL SIZE	M	N	W	T	H	K	S	G	R	V
16 mm	φ 330	φ 330 ± 0.5	φ 97 ± 1.0	17.0 + 1.5 - 0	2.2	φ 13.0 + 0.5 - 0.2	10.6	2.0 ±0.5	---	---	---