



N-Channel Logic Level Enhancement Mode Field Effect Transistor

PRODUCT SUMMARY

VDSS	ID	RDS(ON) (mΩ) Max
30V	40A	9.6 @ VGS=10V
		15 @ VGS=4.5V

FEATURES

- Super high dense cell design for low RDS(ON).
- Rugged and reliable.
- TO-252 and TO-251 Package.

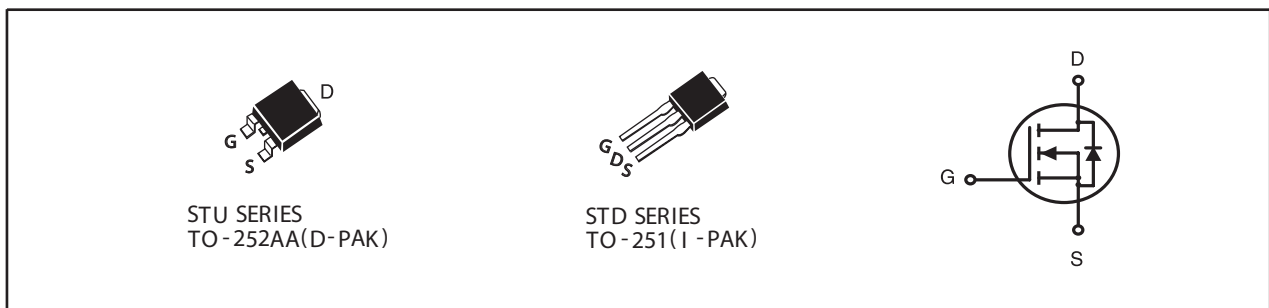

ABSOLUTE MAXIMUM RATINGS (T_C=25°C unless otherwise noted)

Symbol	Parameter	Limit	Units
V _{DS}	Drain-Source Voltage	30	V
V _{GS}	Gate-Source Voltage	±20	V
I _D	Drain Current-Continuous	T _C =25°C	40
		T _C =70°C	32
I _{DM}	-Pulsed ^a	117	A
E _{AS}	Single Pulse Avalanche Energy ^c	56	mJ
P _D	Maximum Power Dissipation	T _C =25°C	42
		T _C =70°C	27
T _J , T _{STG}	Operating Junction and Storage Temperature Range	-55 to 150	°C

THERMAL CHARACTERISTICS

R _{θJC}	Thermal Resistance, Junction-to-Case	3	°C/W
R _{θJA}	Thermal Resistance, Junction-to-Ambient	50	°C/W

STU/D339S

Ver 1.0

ELECTRICAL CHARACTERISTICS (T_C=25°C unless otherwise noted)

Symbol	Parameter	Conditions	Min	Typ	Max	Units
OFF CHARACTERISTICS						
BV _{DSS}	Drain-Source Breakdown Voltage	V _{GS} =0V , I _D =250uA	30			V
I _{DSS}	Zero Gate Voltage Drain Current	V _{DS} =24V , V _{GS} =0V			1	uA
I _{GSS}	Gate-Body Leakage Current	V _{GS} = ±20V , V _{DS} =0V			±100	nA
ON CHARACTERISTICS						
V _{GS(th)}	Gate Threshold Voltage	V _{DS} =V _{GS} , I _D =250uA	1.0	1.7	3	V
R _{DS(ON)}	Drain-Source On-State Resistance	V _{GS} =10V , I _D =20A		8.2	9.6	m ohm
		V _{GS} =4.5V , I _D =16A		11.5	15	m ohm
g _{FS}	Forward Transconductance	V _{DS} =10V , I _D =20A		55		S
DYNAMIC CHARACTERISTICS ^b						
C _{ISS}	Input Capacitance	V _{DS} =15V, V _{GS} =0V f=1.0MHz		900		pF
C _{OSS}	Output Capacitance			161		pF
C _{RSS}	Reverse Transfer Capacitance			124		pF
SWITCHING CHARACTERISTICS ^b						
t _{D(ON)}	Turn-On Delay Time	V _{DD} =15V I _D =1A V _{GS} =10V R _{GEN} = 6 ohm		17		ns
t _r	Rise Time			18		ns
t _{D(OFF)}	Turn-Off Delay Time			18		ns
t _f	Fall Time			46		ns
Q _g	Total Gate Charge	V _{DS} =15V, I _D =20A, V _{GS} =10V		14		nC
		V _{DS} =15V, I _D =20A, V _{GS} =4.5V		6.5		nC
Q _{gs}	Gate-Source Charge	V _{DS} =15V, I _D =20A, V _{GS} =10V		1.8		nC
Q _{gd}	Gate-Drain Charge			4.1		nC
DRAIN-SOURCE DIODE CHARACTERISTICS AND MAXIMUM RATINGS						
V _{SD}	Diode Forward Voltage	V _{GS} =0V, I _S =2A		0.77	1.3	V

Notes

- a. Pulse Test: Pulse Width ≤ 300us, Duty Cycle ≤ 2%.
 b. Guaranteed by design, not subject to production testing.
 c. Starting T_J=25°C, L=0.5mH, V_{DD} = 20V. (See Figure13)

Aug, 17, 2012

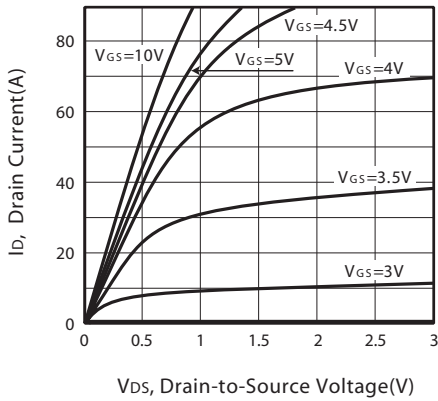

Figure 1. Output Characteristics

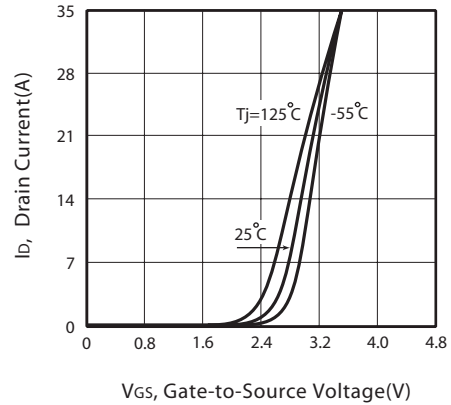

Figure 2. Transfer Characteristics

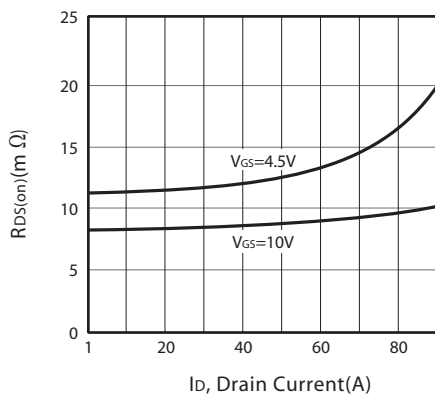

Figure 3. On-Resistance vs. Drain Current and Gate Voltage

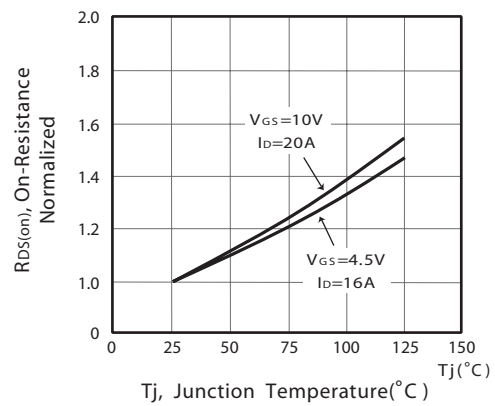

Figure 4. On-Resistance Variation with Drain Current and Temperature

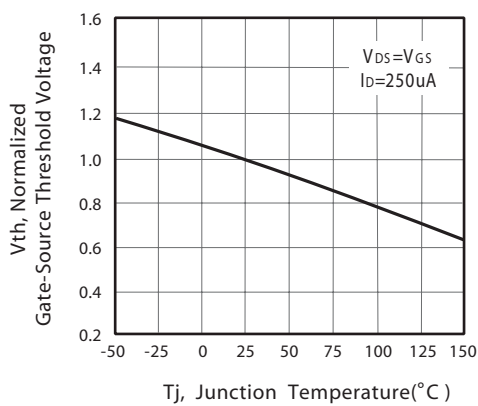

Figure 5. Gate Threshold Variation with Temperature

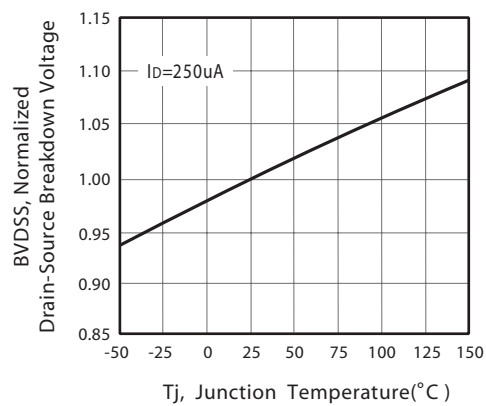

Figure 6. Breakdown Voltage Variation with Temperature

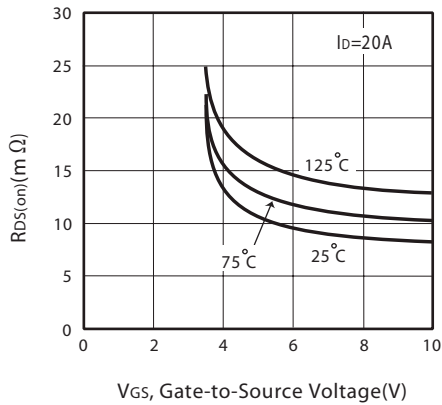

Figure 7. On-Resistance vs. Gate-Source Voltage

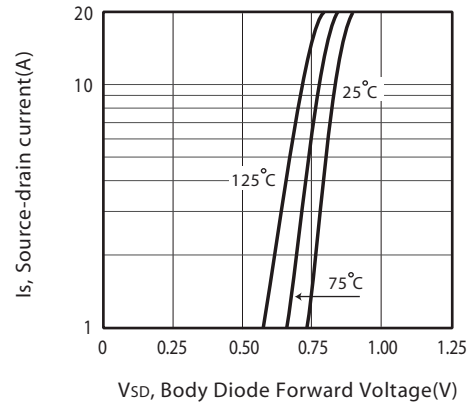

Figure 8. Body Diode Forward Voltage Variation with Source Current

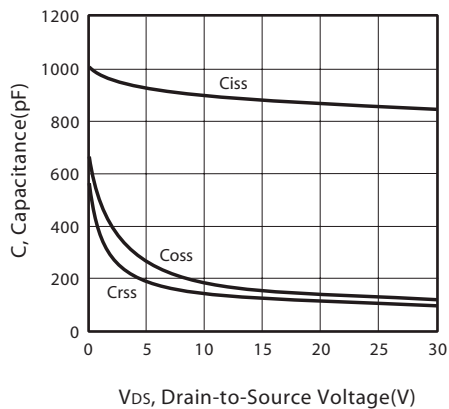

Figure 9. Capacitance

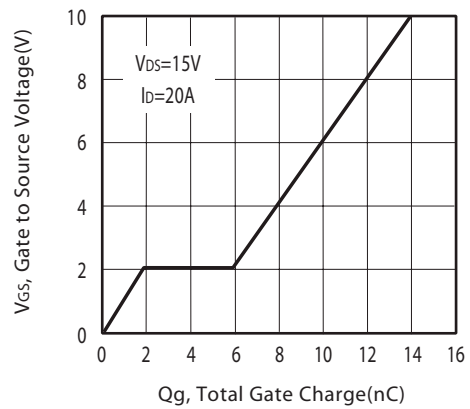

Figure 10. Gate Charge

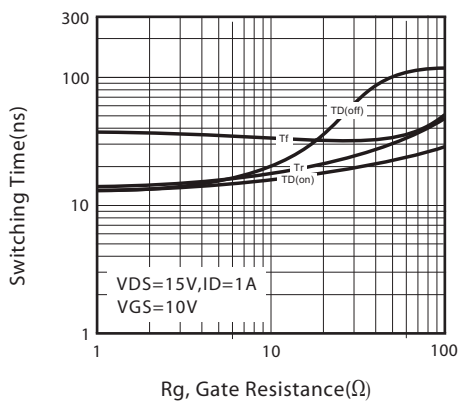

Figure 11. switching characteristics

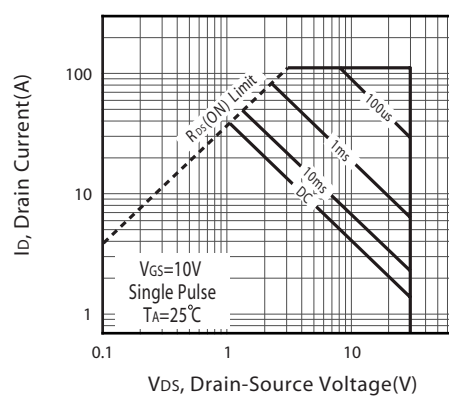
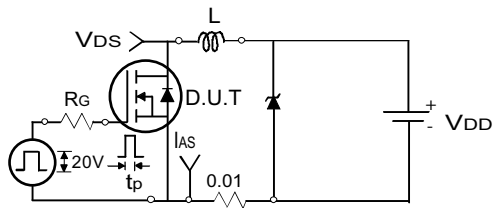
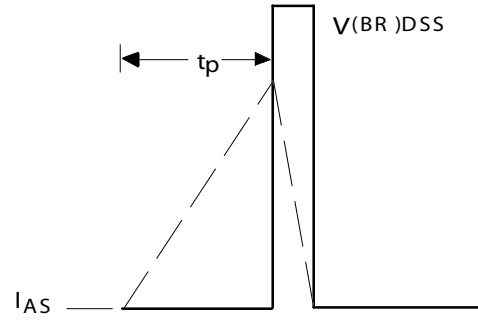

Figure 12. Maximum Safe Operating Area



Uncamped Inductive Test Circuit

Figure 13a.



Unclamped Inductive Waveforms

Figure 13b.

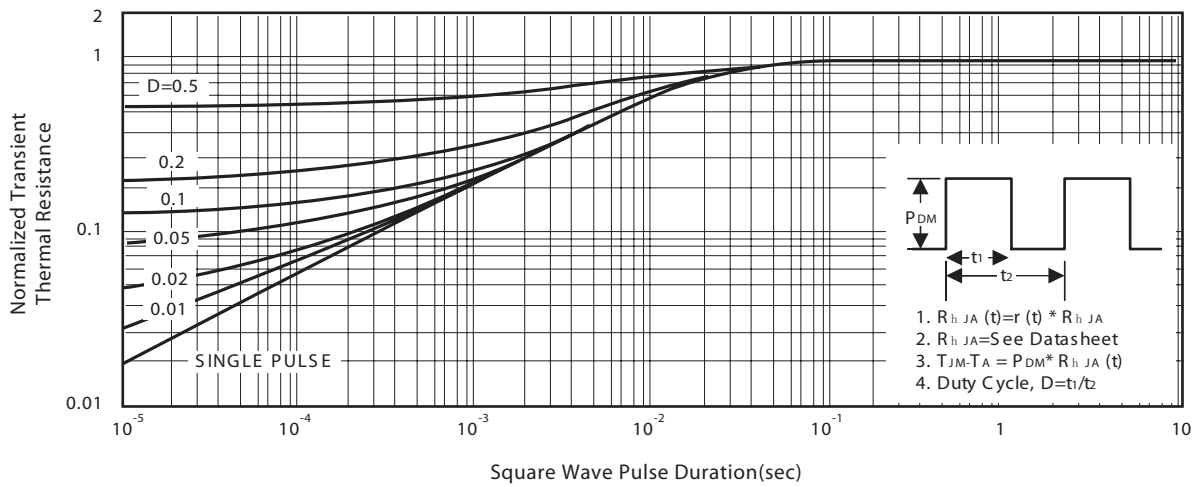
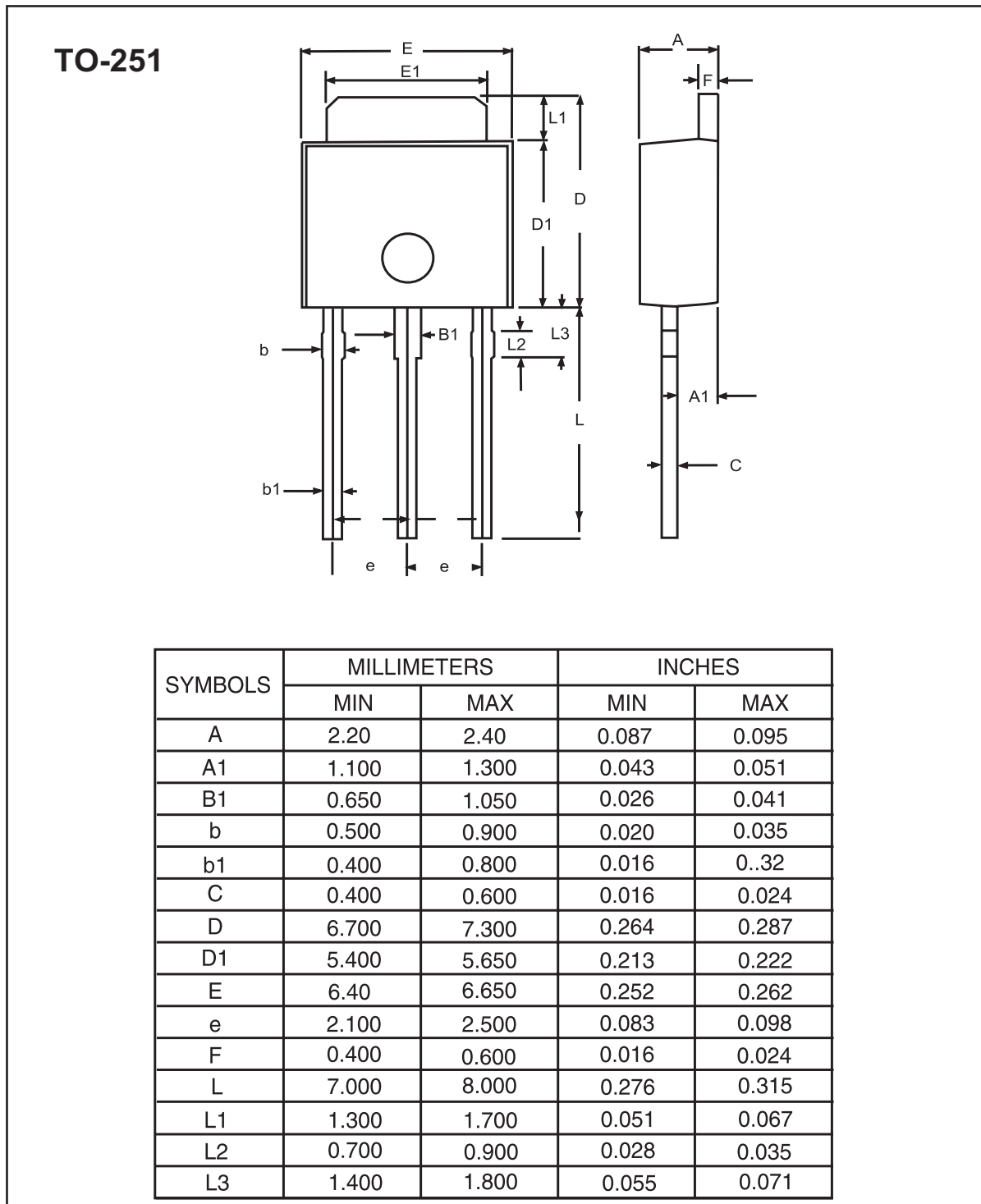
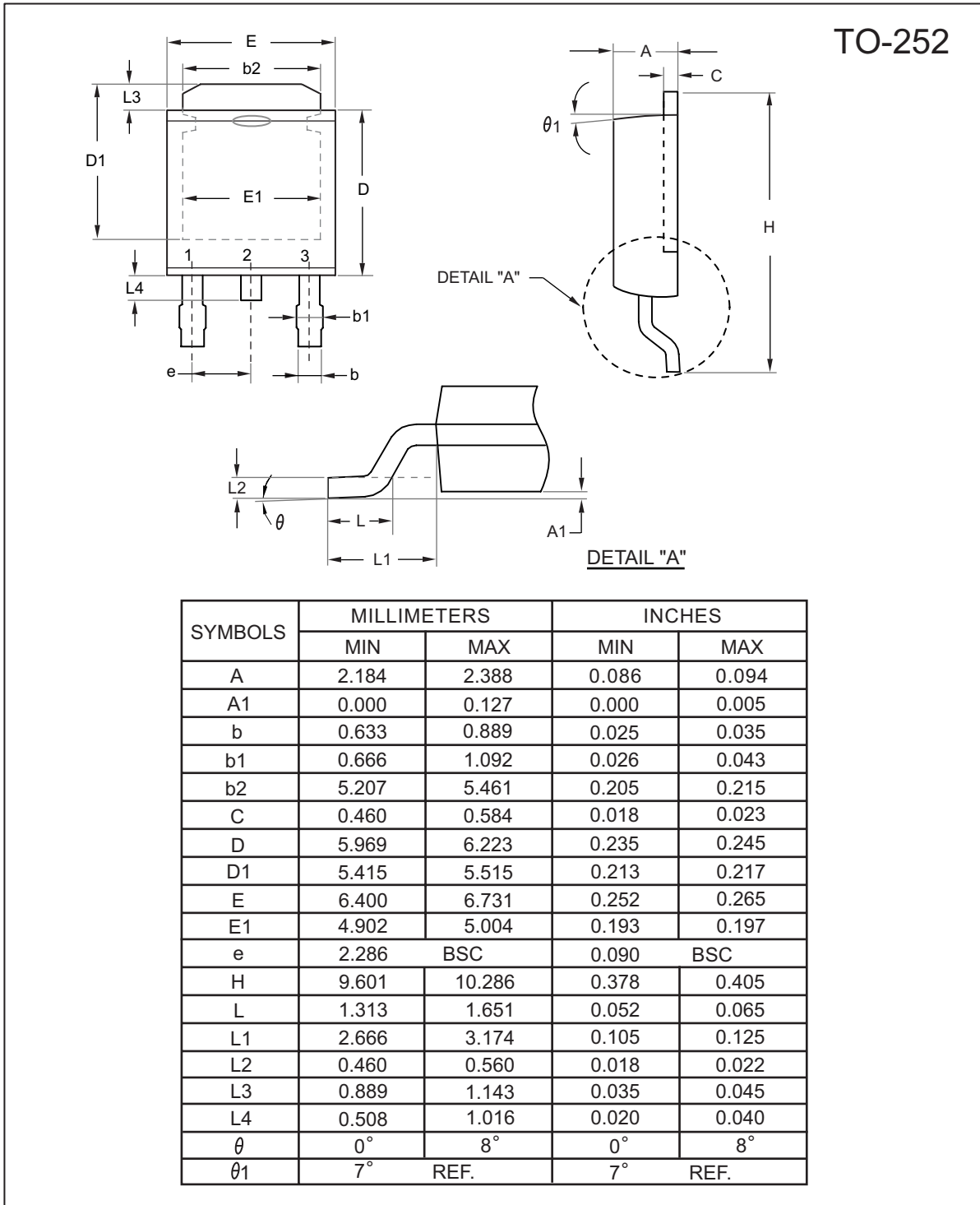

Figure 14. Normalized Thermal Transient Impedance Curve

PACKAGE OUTLINE DIMENSIONS





TO-251 Tube/TO-252 Tape and Reel Data

TO-251 Tube

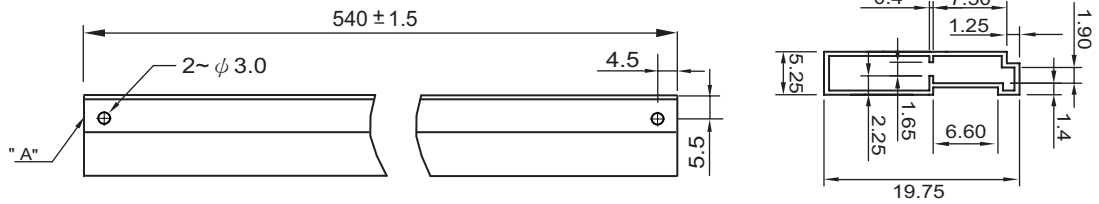

TO-252 Carrier Tape

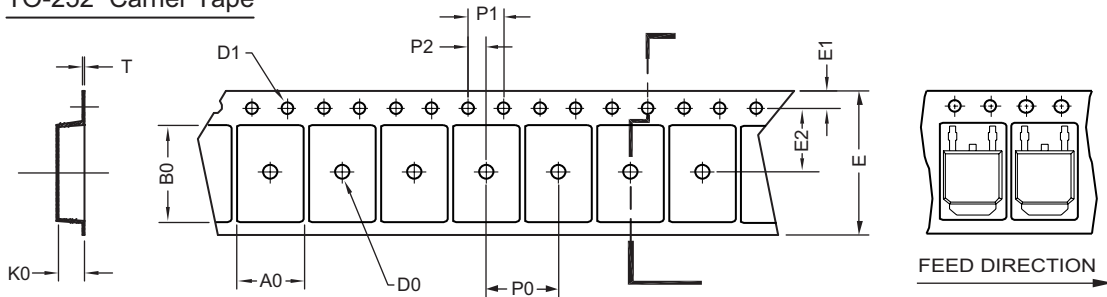

UNIT:mm

PACKAGE	A0	B0	K0	D0	D1	E	E1	E2	P0	P1	P2	T
TO-252 (16 mm)	6.96 ±0.1	10.49 ±0.1	2.79 ±0.1	φ 2	φ 1.5 + 0.1 - 0	16.0 ±0.3	1.75 ±0.1	7.5 ±0.15	8.0 ±0.1	4.0 ±0.1	2.0 ±0.15	0.3 ±0.05

TO-252 Reel

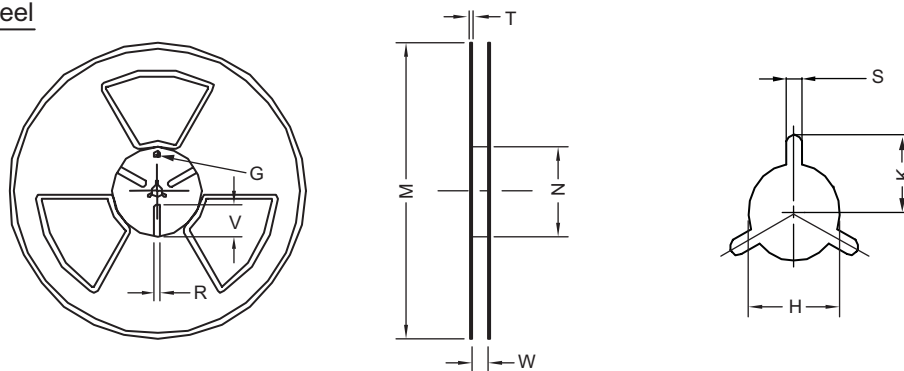

UNIT:mm

TAPE SIZE	REEL SIZE	M	N	W	T	H	K	S	G	R	V
16 mm	φ 330	φ 330 ± 0.5	φ 97 ± 1.0	17.0 + 1.5 - 0	2.2	φ 13.0 + 0.5 - 0.2	10.6	2.0 ±0.5	---	---	---