



N-Channel Logic Level Enhancement Mode Field Effect Transistor

PRODUCT SUMMARY

V _{DSS}	I _D	R _{DS(ON)} (mΩ) Typ
100V	35A	20 @ V _{GS} =10V

FEATURES

- Super high dense cell design for low R_{DS(ON)}.
- Rugged and reliable.
- TO-252 and TO-251 Package.

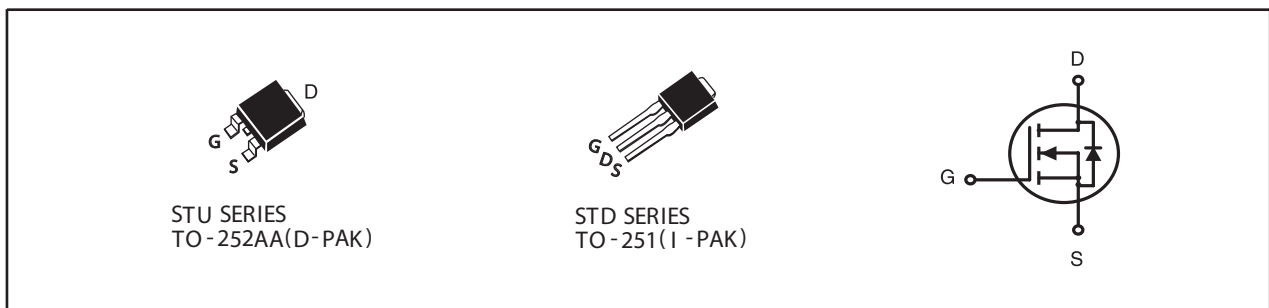

ABSOLUTE MAXIMUM RATINGS (T_C=25°C unless otherwise noted)

Symbol	Parameter	Limit	Units
V _{DS}	Drain-Source Voltage	100	V
V _{GS}	Gate-Source Voltage	±20	V
I _D	Drain Current-Continuous ^a	T _C =25°C	35
		T _C =70°C	29
I _{DM}	-Pulsed ^b	92	A
E _{AS}	Single Pulse Avalanche Energy ^d	156	mJ
P _D	Maximum Power Dissipation ^a	T _C =25°C	60
		T _C =70°C	42
T _J , T _{STG}	Operating Junction and Storage Temperature Range	-55 to 175	°C

THERMAL CHARACTERISTICS

R _{θJC}	Thermal Resistance, Junction-to-Case ^a	2.5	°C/W
R _{θJA}	Thermal Resistance, Junction-to-Ambient ^a	50	°C/W

STU/D35L01HA

Ver 1.0

ELECTRICAL CHARACTERISTICS (T_C=25°C unless otherwise noted)

Symbol	Parameter	Conditions	Min	Typ	Max	Units
OFF CHARACTERISTICS						
BV _{DSS}	Drain-Source Breakdown Voltage	V _{GS} =0V, I _D =250uA	100			V
BV _{DSS}	Drain-Source Breakdown Voltage ^e	V _{GS} =0V, I _D =10mA	110			V
I _{DSS}	Zero Gate Voltage Drain Current	V _{DS} =80V, V _{GS} =0V			1	uA
I _{GSS}	Gate-Body Leakage Current	V _{GS} = ±20V, V _{DS} =0V			±100	nA
ON CHARACTERISTICS						
V _{GS(th)}	Gate Threshold Voltage	V _{DS} =V _{GS} , I _D =250uA	2	2.7	4	V
R _{DS(ON)}	Drain-Source On-State Resistance	V _{GS} =10V, I _D =17A		20	25	m ohm
g _{FS}	Forward Transconductance	V _{DS} =10V, I _D =17A		32		S
DYNAMIC CHARACTERISTICS^c						
C _{ISS}	Input Capacitance	V _{DS} =25V, V _{GS} =0V f=1.0MHz		3160		pF
C _{OSS}	Output Capacitance			215		pF
C _{RSS}	Reverse Transfer Capacitance			178		pF
SWITCHING CHARACTERISTICS^c						
t _{D(ON)}	Turn-On Delay Time	V _{DD} =50V I _D =1A V _{GS} =10V R _{GEN} = 6 ohm		81		ns
t _r	Rise Time			85		ns
t _{D(OFF)}	Turn-Off Delay Time			115		ns
t _f	Fall Time			25		ns
Q _g	Total Gate Charge	V _{DS} =50V, I _D =17A, V _{GS} =10V		57		nC
Q _{gs}	Gate-Source Charge	V _{DS} =50V, I _D =17A, V _{GS} =10V		8.5		nC
Q _{gd}	Gate-Drain Charge			22		nC
DRAIN-SOURCE DIODE CHARACTERISTICS AND MAXIMUM RATINGS						
V _{SD}	Diode Forward Voltage	V _{GS} =0V, I _S =5A		0.77	1.3	V
Notes						
<p>a. Surface Mounted on FR4 Board, t ≤ 10sec.</p> <p>b. Pulse Test: Pulse Width ≤ 300us, Duty Cycle ≤ 2%.</p> <p>c. Guaranteed by design, not subject to production testing.</p> <p>d. Starting T_J=25°C, L=0.5mH, V_{DD} = 50V. (See Figure 13)</p> <p>e. Pulse Test: Pulse Width ≤ 1us, Duty Cycle ≤ 1%.</p>						

Mar,30,2011

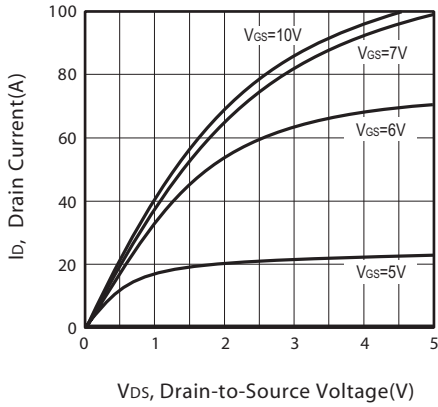

Figure 1. Output Characteristics

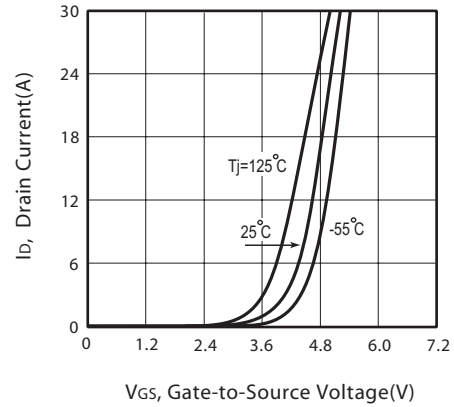

Figure 2. Transfer Characteristics

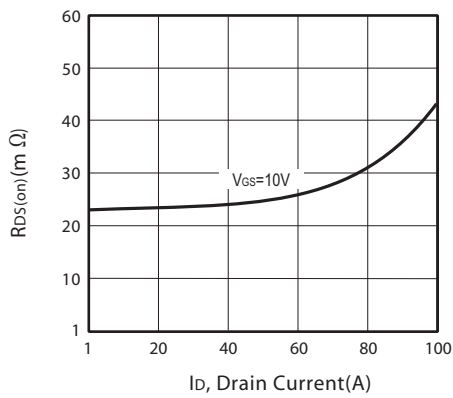

Figure 3. On-Resistance vs. Drain Current and Gate Voltage

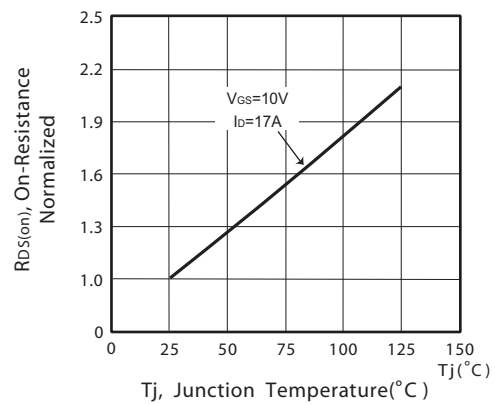

Figure 4. On-Resistance Variation with Drain Current and Temperature

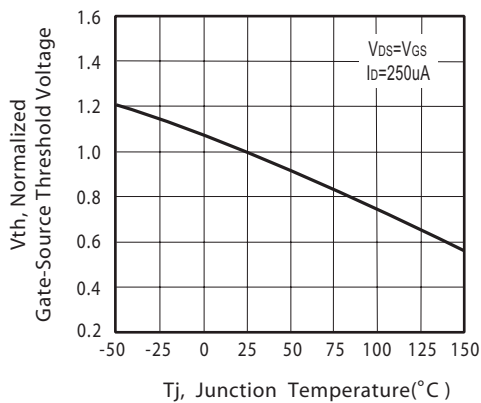

Figure 5. Gate Threshold Variation with Temperature

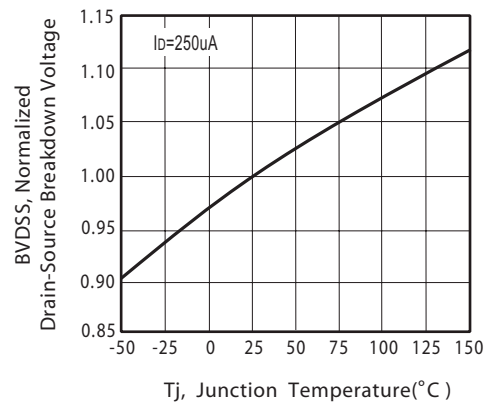

Figure 6. Breakdown Voltage Variation with Temperature

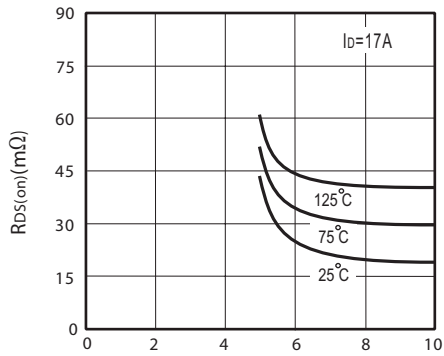

Figure 7. On-Resistance vs. Gate-Source Voltage

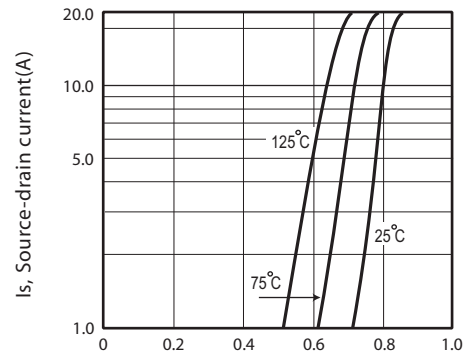

Figure 8. Body Diode Forward Voltage Variation with Source Current

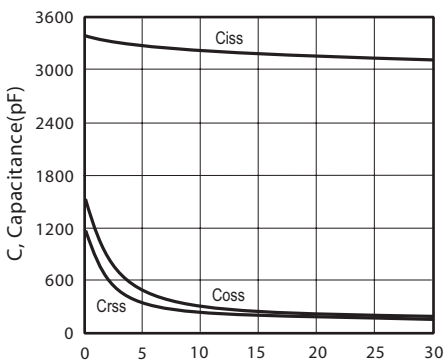

Figure 9. Capacitance

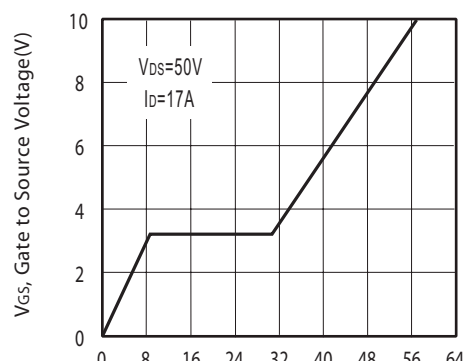

Figure 10. Gate Charge

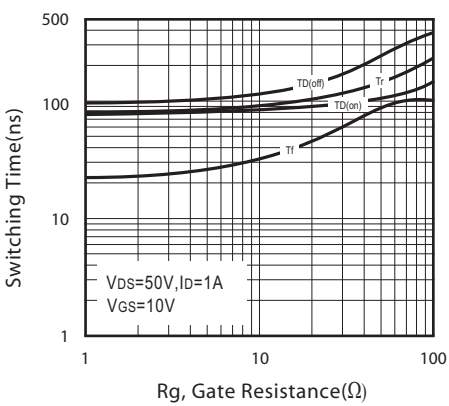

Figure 11. switching characteristics

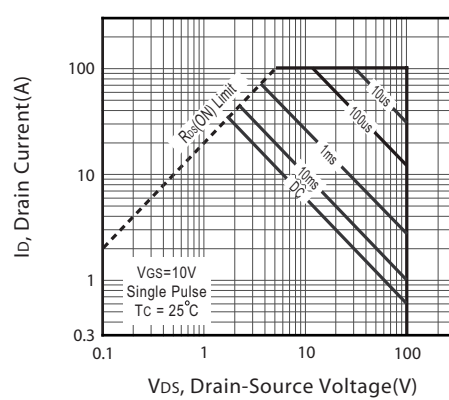
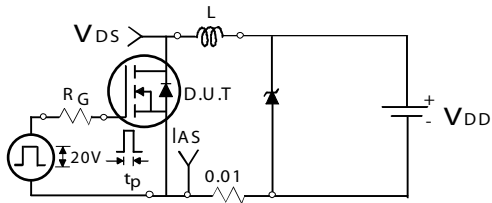
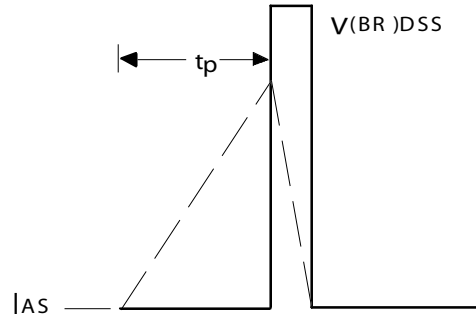

Figure 12. Maximum Safe Operating Area



Unclamped Inductive Test Circuit

Figure 13a.



Unclamped Inductive Waveforms

Figure 13b.

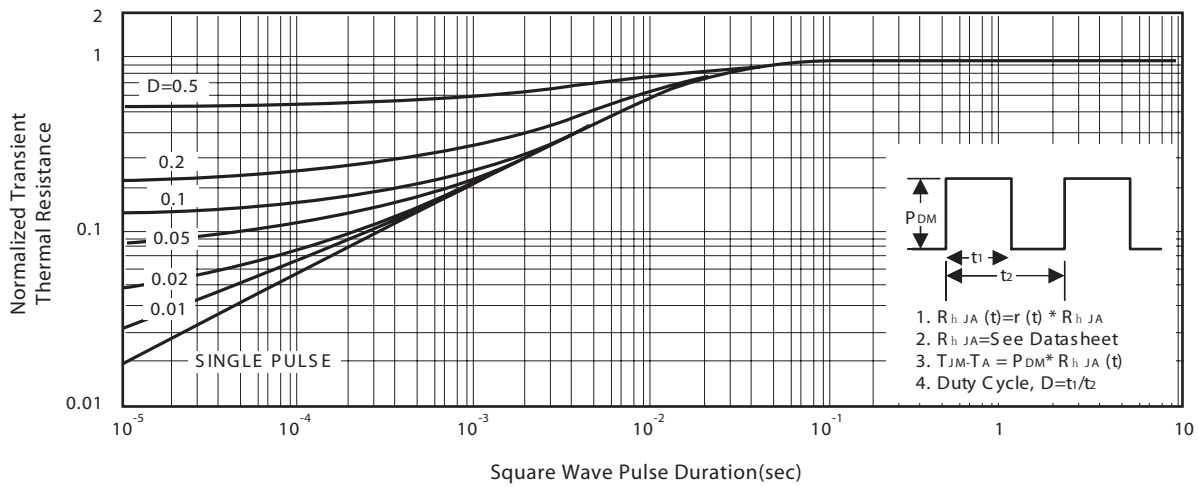
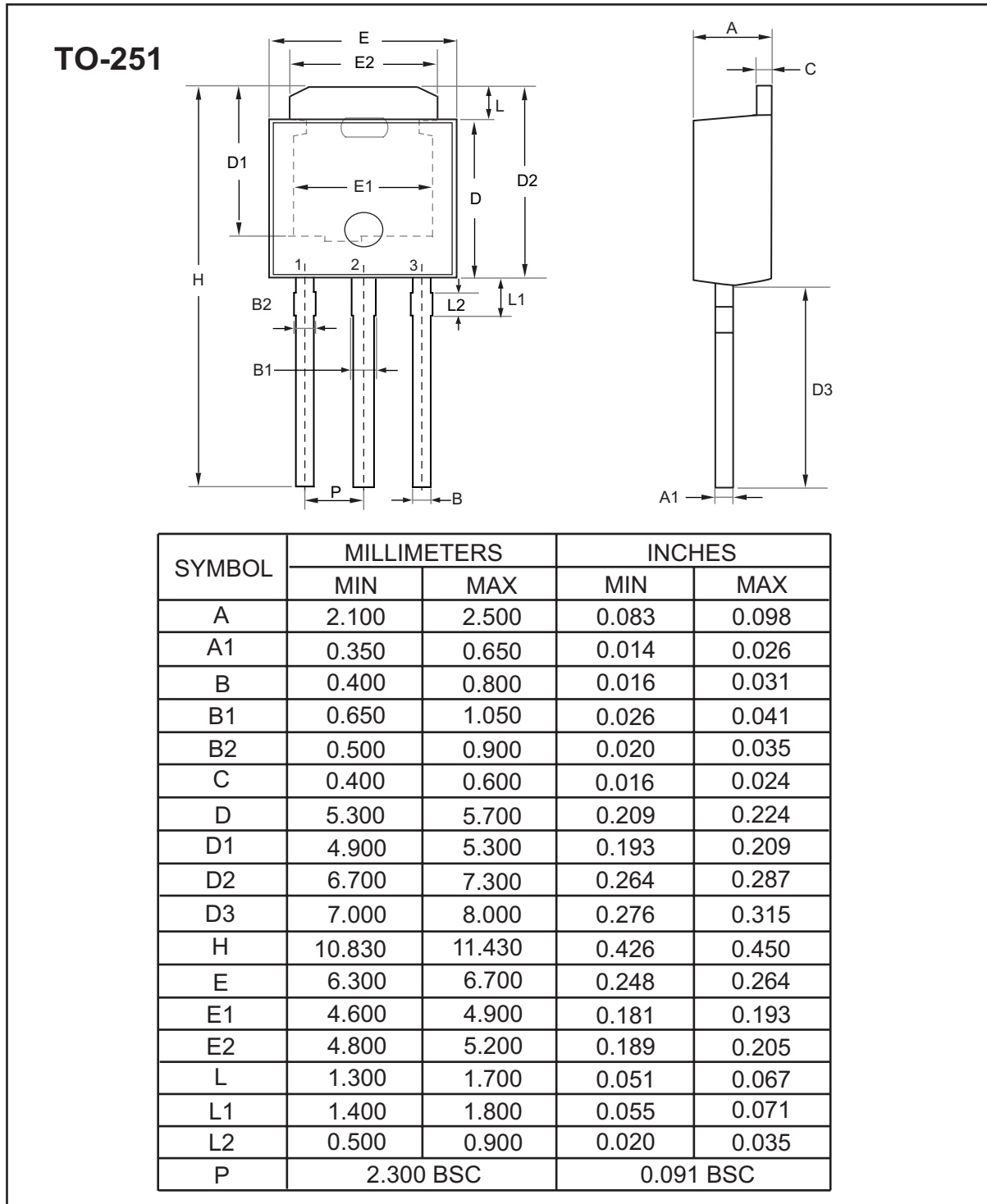

Figure 14. Normalized Thermal Transient Impedance Curve

PACKAGE OUTLINE DIMENSIONS



STU/D35L01HA

Ver 1.0

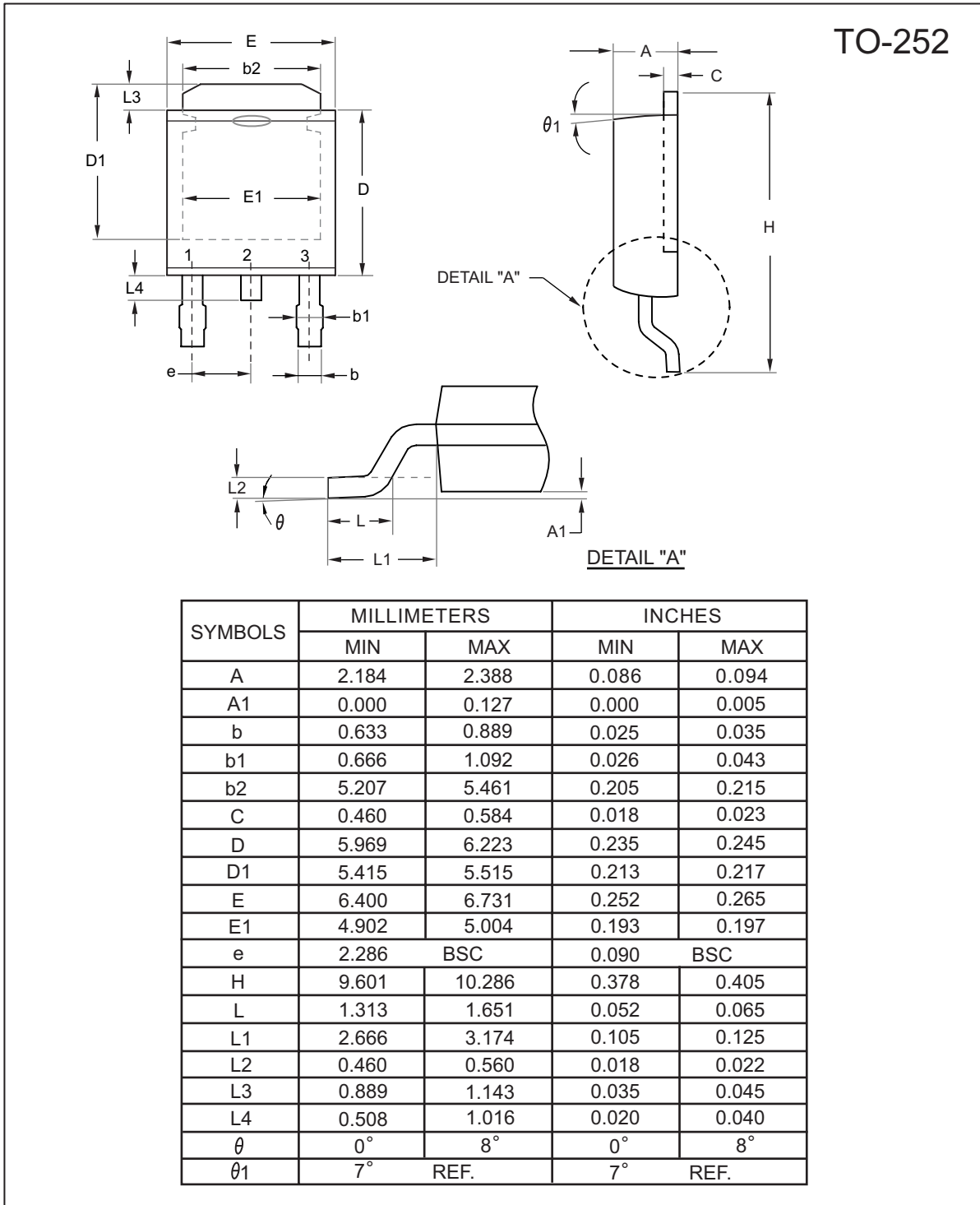

Mar,30,2011

TO-251 Tube/TO-252 Tape and Reel Data

TO-251 Tube



TO-252 Carrier Tape



UNIT:mm

PACKAGE	A0	B0	K0	D0	D1	E	E1	E2	P0	P1	P2	T
TO-252 (16 mm)	6.96 ±0.1	10.49 ±0.1	2.79 ±0.1	φ 2	φ 1.5 + 0.1 - 0	16.0 ±0.3	1.75 ±0.1	7.5 ±0.15	8.0 ±0.1	4.0 ±0.1	2.0 ±0.15	0.3 ±0.05

TO-252 Reel

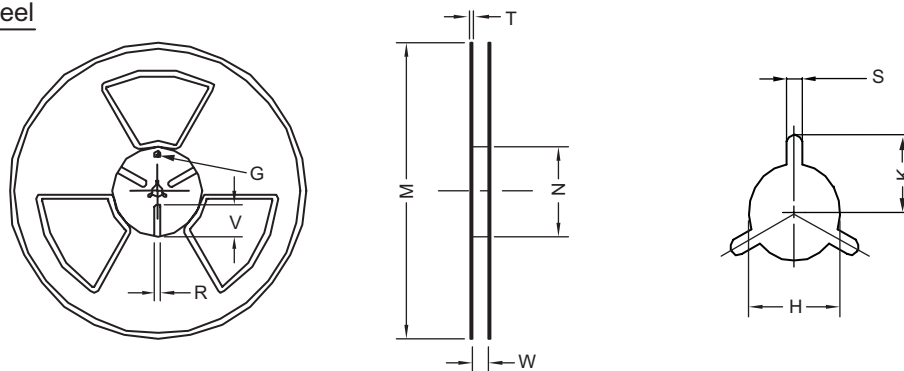

UNIT:mm

TAPE SIZE	REEL SIZE	M	N	W	T	H	K	S	G	R	V
16 mm	φ 330	φ 330 ± 0.5	φ 97 ± 1.0	17.0 + 1.5 - 0	2.2	φ 13.0 + 0.5 - 0.2	10.6	2.0 ±0.5	---	---	---