



N-Channel Logic Level Enhancement Mode Field Effect Transistor

PRODUCT SUMMARY

V _{DSS}	I _D	R _{DS(ON)} (mΩ) Typ
100V	35A	21 @ V _{GS} =10V
		30 @ V _{GS} =4.5V

FEATURES

- Super high dense cell design for low R_{DS(ON)}.
- Rugged and reliable.
- TO-252 and TO-251 Package.

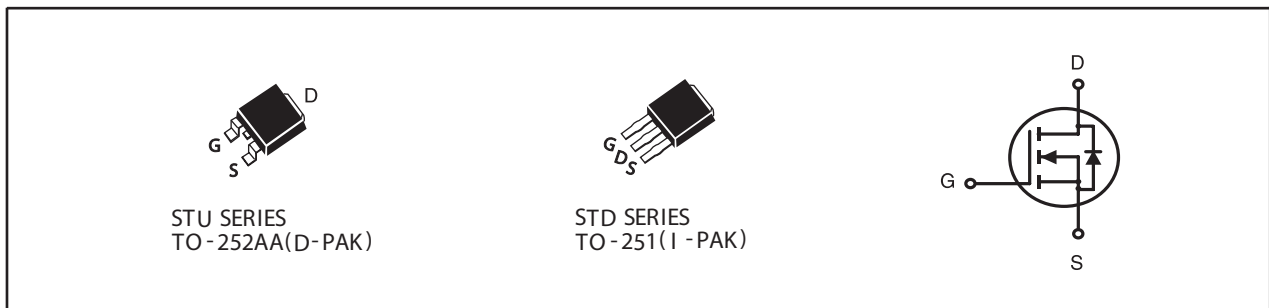

ABSOLUTE MAXIMUM RATINGS (T_C=25°C unless otherwise noted)

Symbol	Parameter	Limit	Units
V _{DS}	Drain-Source Voltage	100	V
V _{GS}	Gate-Source Voltage	±20	V
I _D	Drain Current-Continuous ^{a c}	T _C =25°C	35
		T _C =70°C	28
I _{DM}	-Pulsed ^c	102	A
E _{AS}	Single Pulse Avalanche Energy ^d	196	mJ
P _D	Maximum Power Dissipation ^a	T _C =25°C	42
		T _C =70°C	27
T _J , T _{STG}	Operating Junction and Storage Temperature Range	-55 to 150	°C

THERMAL CHARACTERISTICS

R _{θ JC}	Thermal Resistance, Junction-to-Case ^a	3	°C/W
R _{θ JA}	Thermal Resistance, Junction-to-Ambient ^a	50	°C/W

STU35N10

STD35N10

Ver 1.0

ELECTRICAL CHARACTERISTICS (T_C=25°C unless otherwise noted)

Symbol	Parameter	Conditions	Min	Typ	Max	Units
OFF CHARACTERISTICS						
B _V DSS	Drain-Source Breakdown Voltage	V _{GS} =0V , I _D =250uA	100			V
I _{DSS}	Zero Gate Voltage Drain Current	V _{DS} =80V , V _{GS} =0V			1	uA
I _{GSS}	Gate-Body Leakage Current	V _{GS} = ±20V , V _{DS} =0V			±100	nA
ON CHARACTERISTICS						
V _{GS(th)}	Gate Threshold Voltage	V _{DS} =V _{GS} , I _D =250uA	1	1.6	3	V
R _{DS(ON)}	Drain-Source On-State Resistance	V _{GS} =10V , I _D =17.5A		21	26	m ohm
		V _{GS} =4.5V , I _D =15A		30	41	m ohm
g _{FS}	Forward Transconductance	V _{DS} =10V , I _D =17.5A		29		S
DYNAMIC CHARACTERISTICS ^b						
C _{ISS}	Input Capacitance	V _{DS} =25V, V _{GS} =0V f=1.0MHz		2490		pF
C _{OSS}	Output Capacitance			231		pF
C _{RSS}	Reverse Transfer Capacitance			128		pF
SWITCHING CHARACTERISTICS ^b						
t _{D(ON)}	Turn-On Delay Time	V _{DD} =50V I _D =1A V _{GS} =10V R _{GEN} = 6 ohm		50		ns
t _r	Rise Time			43		ns
t _{D(OFF)}	Turn-Off Delay Time			75		ns
t _f	Fall Time			54		ns
Q _g	Total Gate Charge		V _{DS} =50V, I _D =17.5A, V _{GS} =10V		33	
Q _{gs}	Gate-Source Charge	V _{DS} =50V, I _D =17.5A, V _{GS} =10V		3.6		nC
Q _{gd}	Gate-Drain Charge			12		nC
DRAIN-SOURCE DIODE CHARACTERISTICS AND MAXIMUM RATINGS						
V _{SD}	Diode Forward Voltage	V _{GS} =0V, I _S =8A		0.78	1.3	V
Notes						
<p>a.Surface Mounted on FR4 Board of 1 inch² , 1oz.</p> <p>b.Guaranteed by design, not subject to production testing.</p> <p>c.Drain current limited by maximum junction temperature.</p> <p>d.Starting T_J=25°C, L=0.5mH, V_{DD} = 50V.(See Figure13)</p>						

Apr,30,2014

STU35N10 STD35N10

Ver 1.0

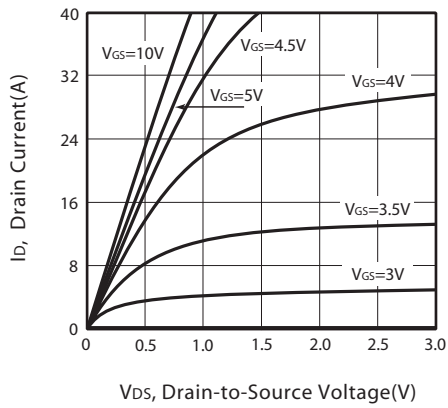

Figure 1. Output Characteristics

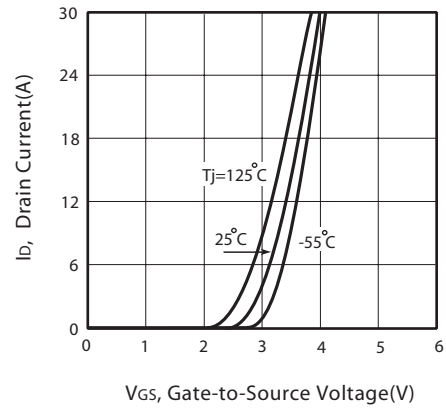

Figure 2. Transfer Characteristics

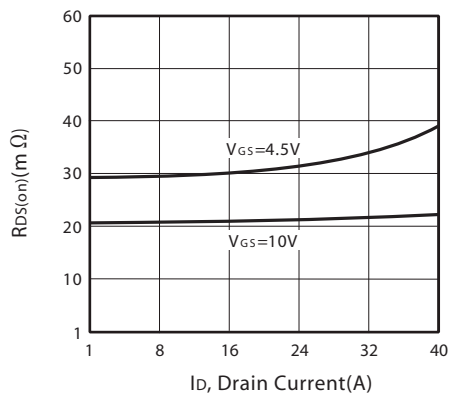

Figure 3. On-Resistance vs. Drain Current and Gate Voltage

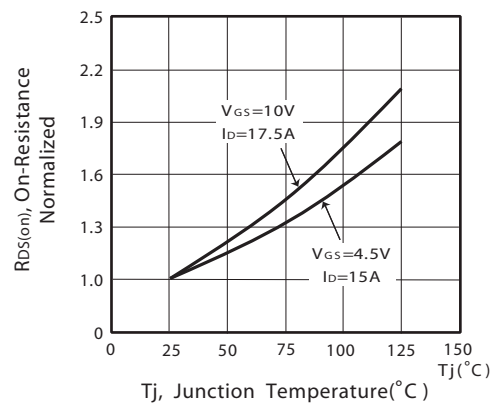

Figure 4. On-Resistance Variation with Drain Current and Temperature

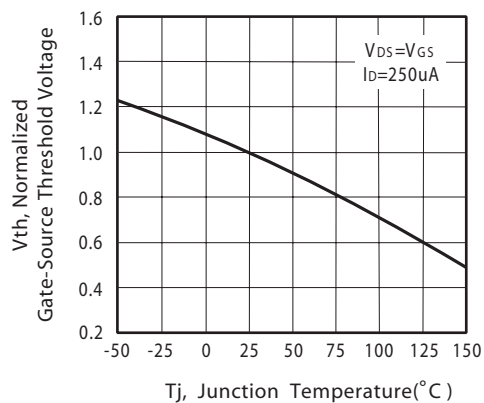

Figure 5. Gate Threshold Variation with Temperature

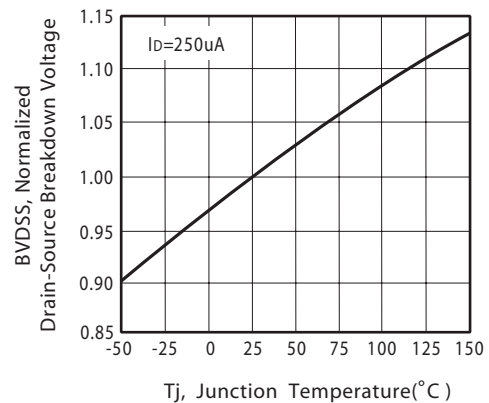

Figure 6. Breakdown Voltage Variation with Temperature

Apr,30,2014

STU35N10 STD35N10

Ver 1.0

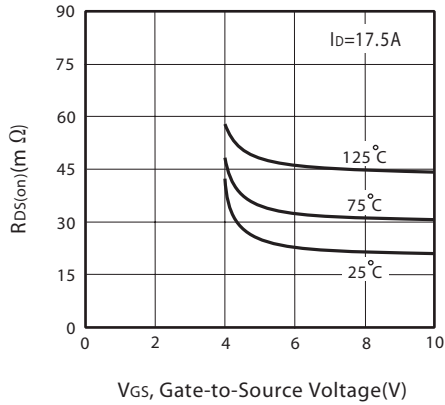

Figure 7. On-Resistance vs. Gate-Source Voltage

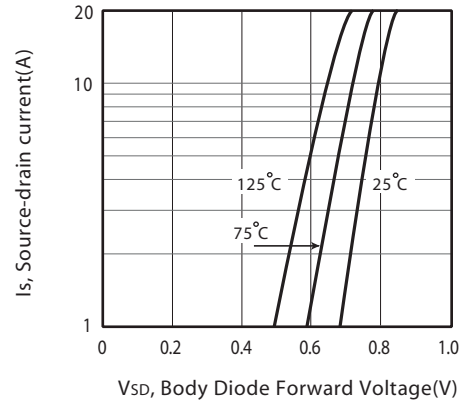

Figure 8. Body Diode Forward Voltage Variation with Source Current

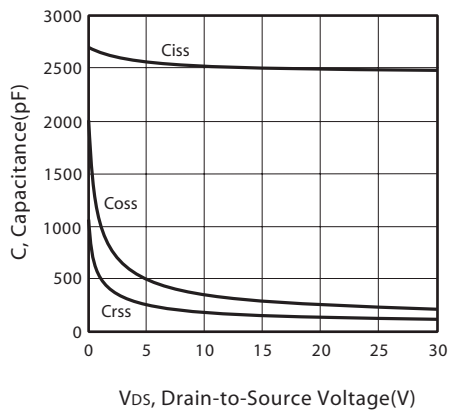

Figure 9. Capacitance

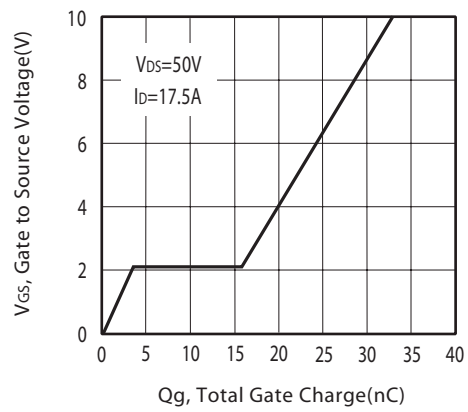

Figure 10. Gate Charge

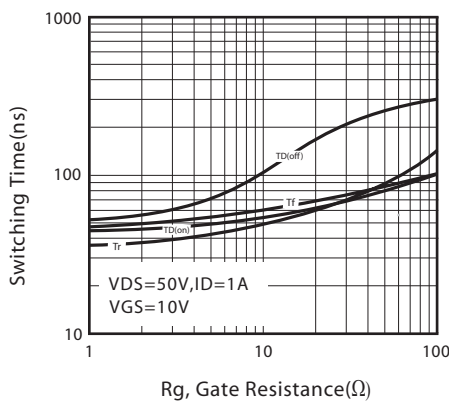

Figure 11. switching characteristics

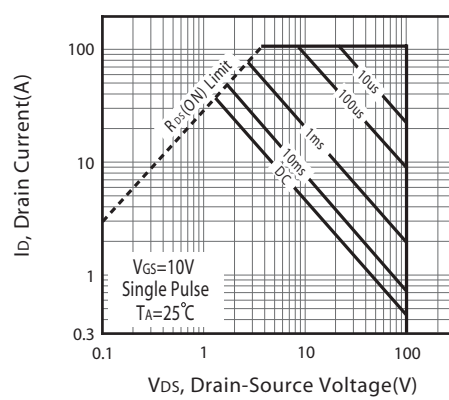
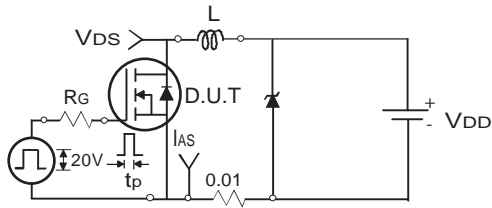

Figure 12. Maximum Safe Operating Area

Apr,30,2014

STU35N10 STD35N10

Ver 1.0



Uncamped Inductive Test Circuit

Figure 13a.

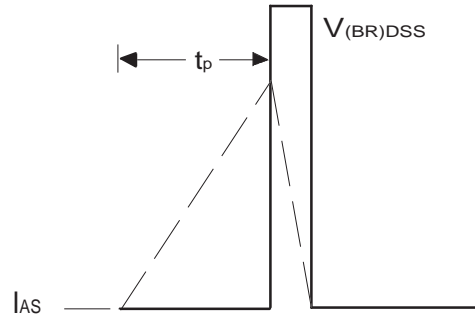

Unclamped Inductive Waveforms

Figure 13b.

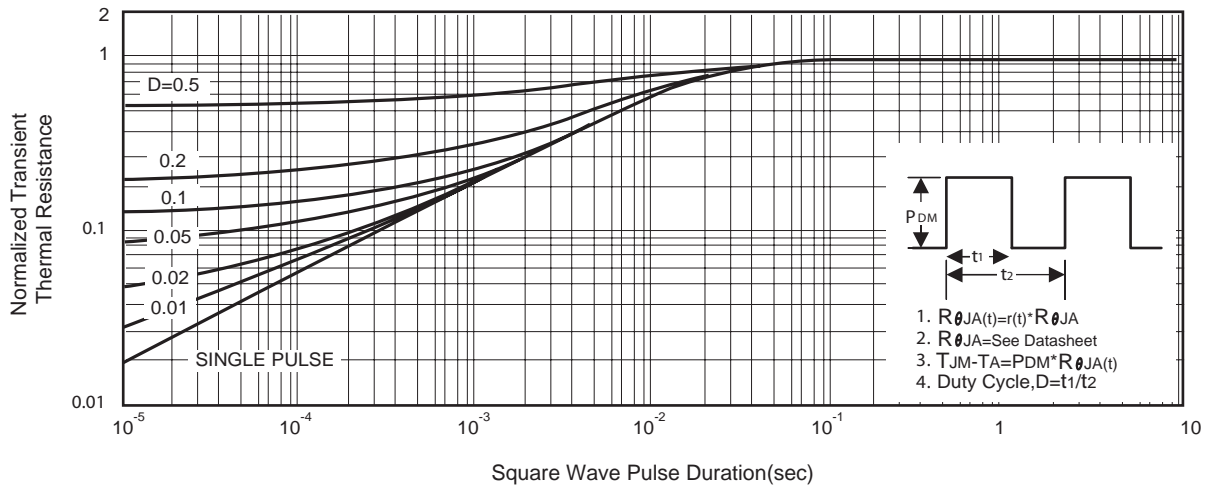

Figure 14. Normalized Thermal Transient Impedance Curve

Apr,30,2014

STU35N10 STD35N10

Ver 1.0

TO-252

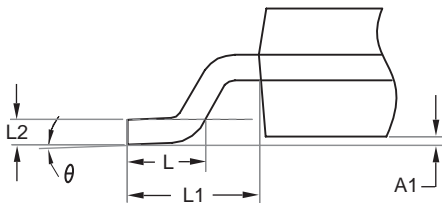
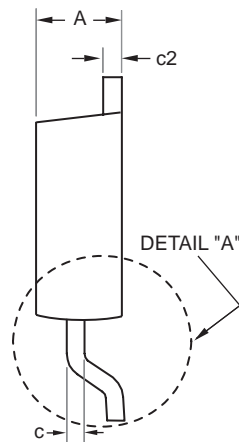
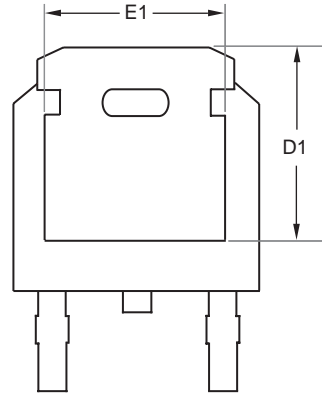
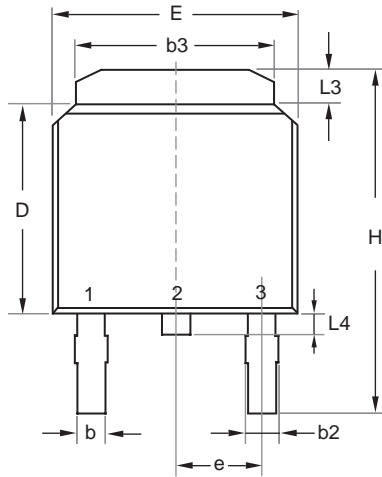

DETAIL "A"

SYMBOLS	MILLIMETERS	
	MIN	MAX
A	2.200	2.380
A1	0.000	0.127
b	0.635	0.889
b2	0.762	1.143
b3	5.200	5.460
c	0.450	0.600
c2	0.450	0.580
D	6.000	6.223
D1	5.210	5.380
e	2.286 BSC	
E	6.400	6.731
E1	4.318	4.900
H	9.400	10.400
L	1.400	1.770
L1	2.743 REF	
L2	0.508 BSC	
L3	0.890	1.270
L4	0.640	1.010
θ	0°	10°

Apr,30,2014

STU35N10 STD35N10

Ver 1.0

PACKAGE OUTLINE DIMENSIONS

TO-251

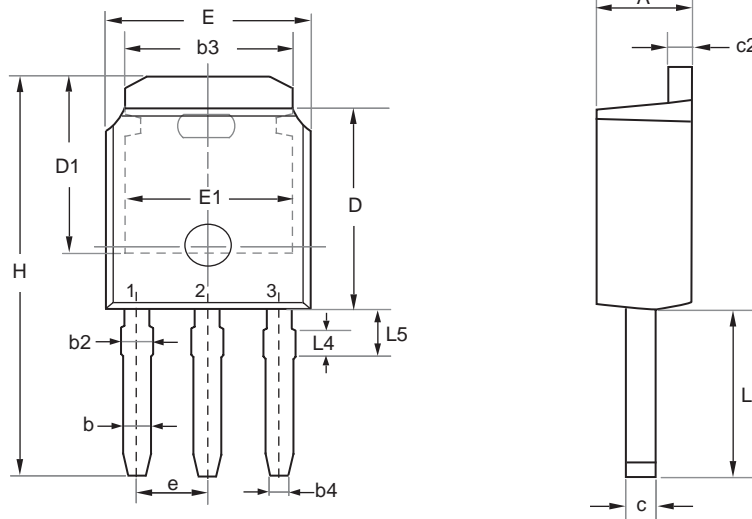

SYMBOL	MILLIMETERS	
	MIN	MAX
E	6.350	6.731
L	3.700	4.400
L4	0.698 REF	
L5	0.972	1.226
D	5.970	6.223
H	9.670	11.450
b	0.630	0.850
b2	0.760	1.140
b3	4.950	5.460
b4	0.450	0.550
e	2.286 BSC	
A	2.180	2.390
c	0.400	0.610
c2	0.400	0.610
D1	5.100	---
E1	4.318	---

Apr,30,2014

STU35N10 STD35N10

Ver 1.0

TO-251 Tube/TO-252 Tape and Reel Data

TO-251 Tube

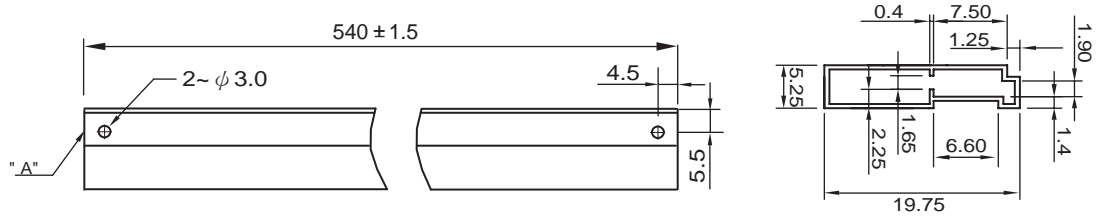

TO-252 Carrier Tape

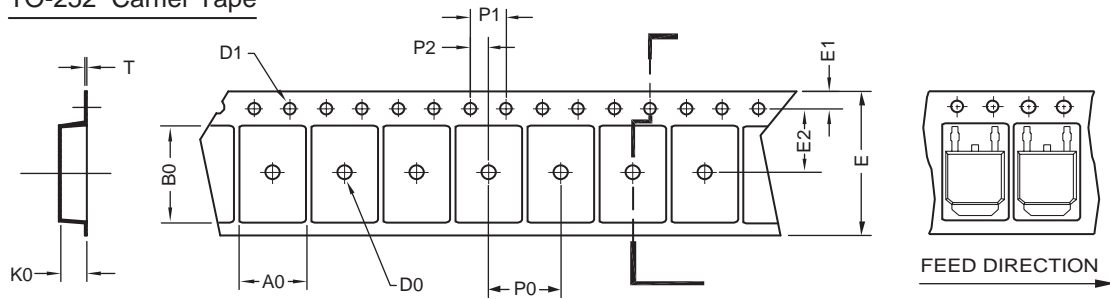

UNIT:mm

PACKAGE	A0	B0	K0	D0	D1	E	E1	E2	P0	P1	P2	T
TO-252 (16 mm)	6.96 ±0.1	10.49 ±0.1	2.79 ±0.1	φ 2	φ 1.5 +0.1 - 0	16.0 ±0.3	1.75 ±0.1	7.5 ±0.15	8.0 ±0.1	4.0 ±0.1	2.0 ±0.15	0.3 ±0.05

TO-252 Reel

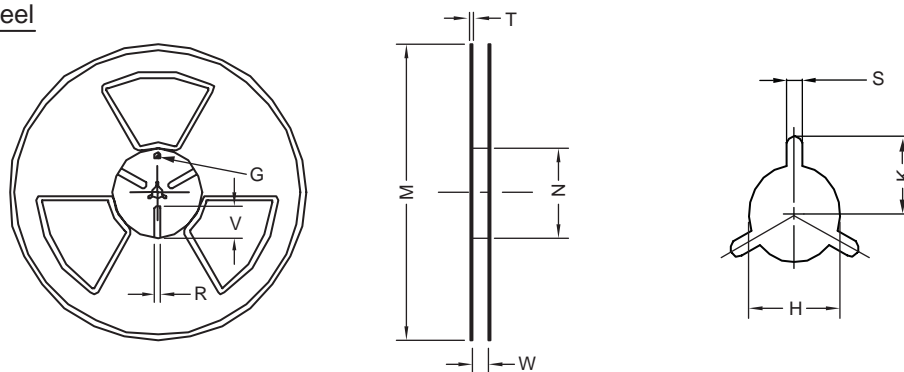

UNIT:mm

TAPE SIZE	REEL SIZE	M	N	W	T	H	K	S	G	R	V
16 mm	φ 330	φ 330 ± 0.5	φ 97 ± 1.0	17.0 + 1.5 - 0	2.2	φ 13.0 + 0.5 - 0.2	10.6	2.0 ±0.5	---	---	---

Apr,30,2014

STU35N10 STD35N10

Ver 1.0

TOP MARKING DEFINITION

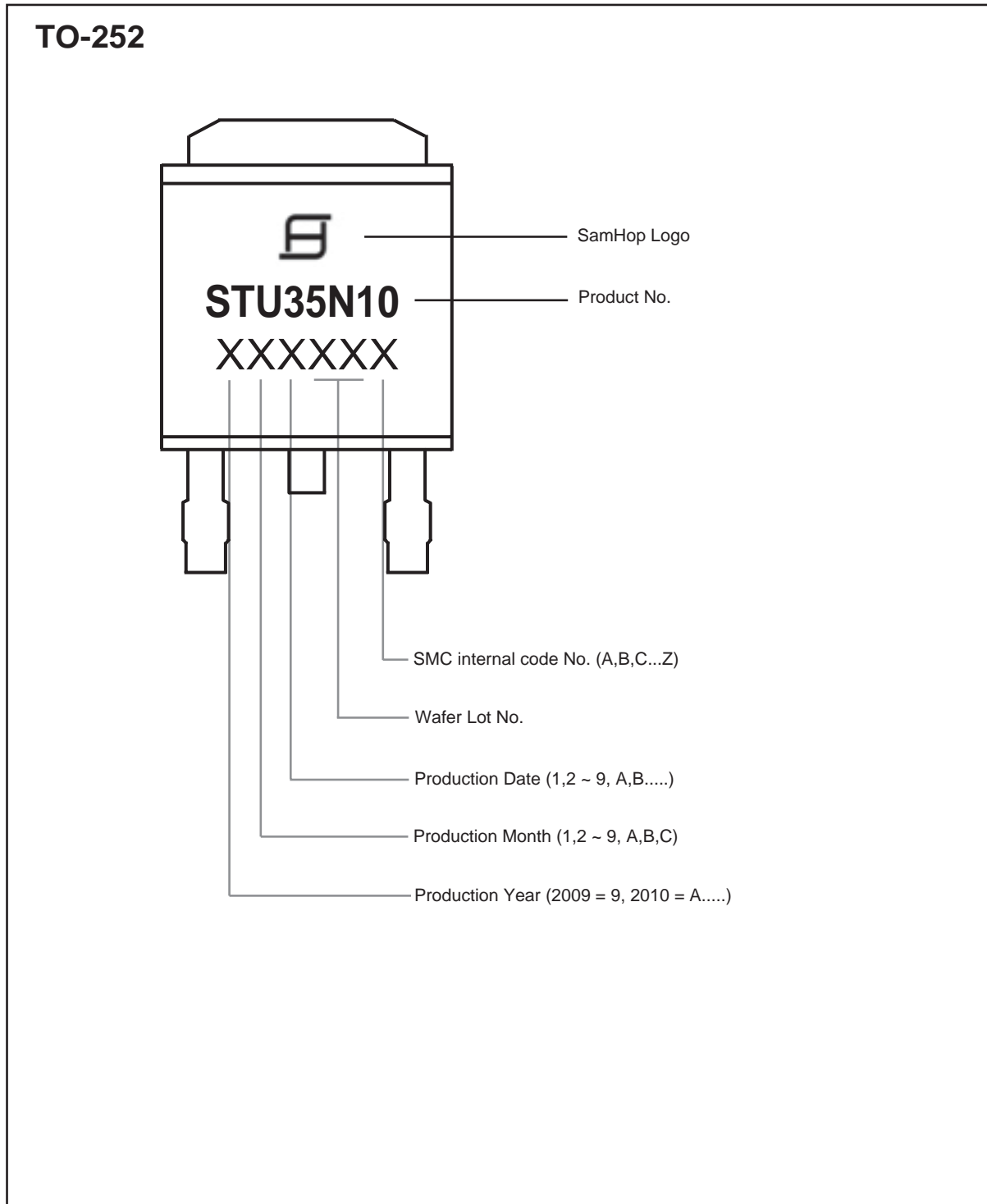

Apr,30,2014

STU35N10 STD35N10

Ver 1.0

TOP MARKING DEFINITION

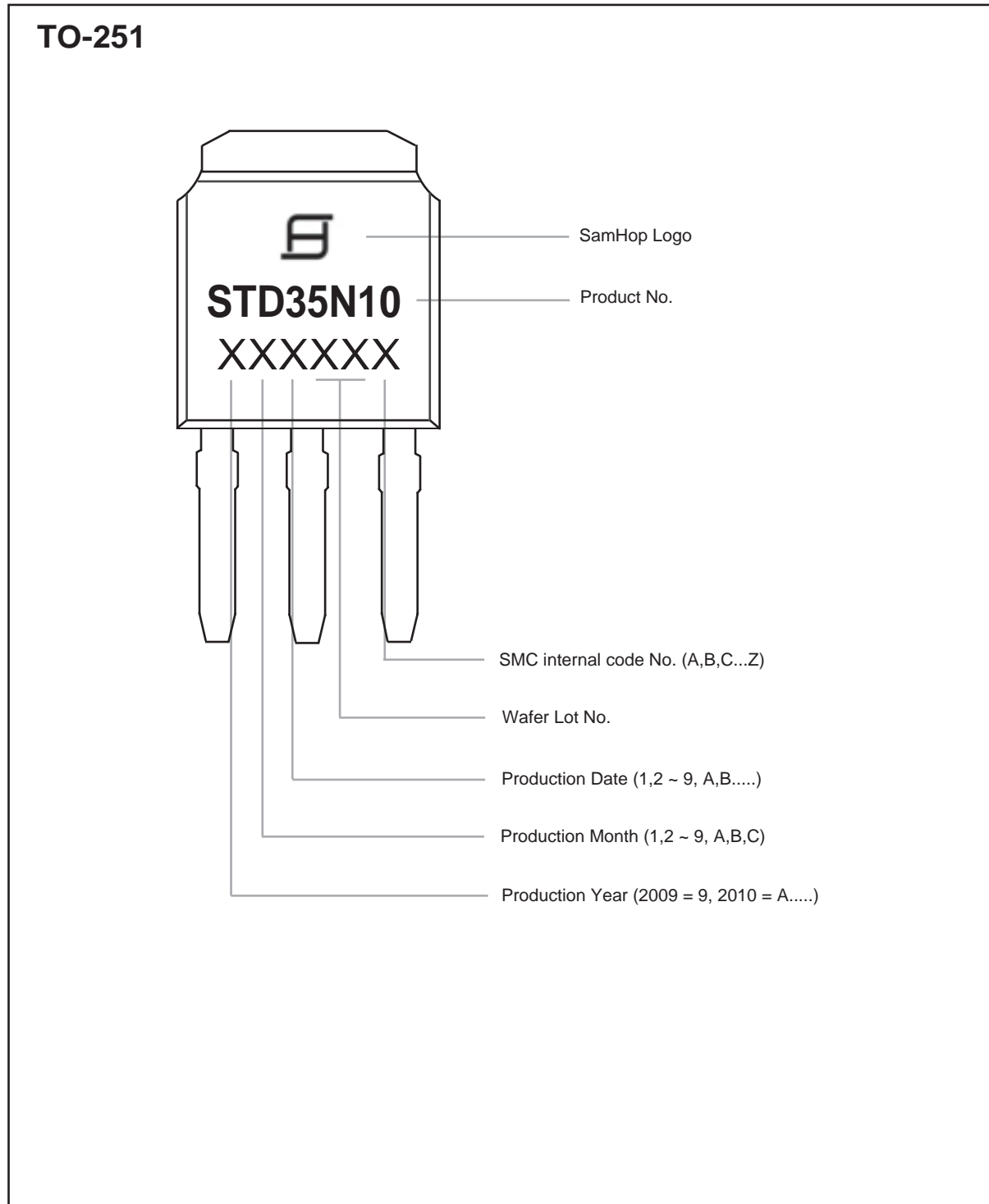

Apr,30,2014