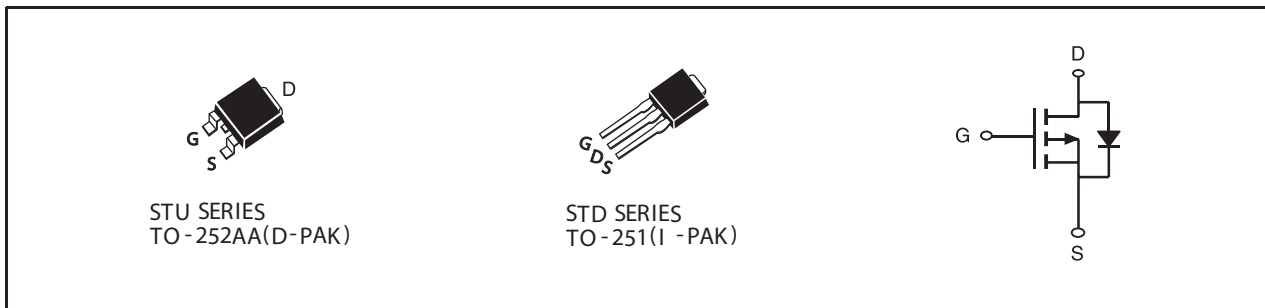

**P-Channel Logic Level Enhancement Mode Field Effect Transistor****PRODUCT SUMMARY**

V <sub>DSS</sub>	I <sub>D</sub>	R <sub>DS(ON)</sub> (mΩ) Max
-40V	-24A	41 @ V <sub>GS</sub> =-10V
		74 @ V <sub>GS</sub> =-4.5V

**FEATURES**

- Super high dense cell design for low R<sub>DS(ON)</sub>.
- Rugged and reliable.
- TO-252 and TO-251 Package.

**ABSOLUTE MAXIMUM RATINGS (T<sub>A</sub>=25°C unless otherwise noted)**

Symbol	Parameter	Limit	Units
V <sub>DS</sub>	Drain-Source Voltage	-40	V
V <sub>GS</sub>	Gate-Source Voltage	±20	V
I <sub>D</sub>	Drain Current-Continuous <sup>a</sup>	T <sub>C</sub> =25°C	-24
		T <sub>C</sub> =70°C	-19
I <sub>DM</sub>	-Pulsed <sup>b</sup>	-73	A
E <sub>AS</sub>	Single Pulse Avalanche Energy <sup>d</sup>	56	mJ
P <sub>D</sub>	Maximum Power Dissipation <sup>a</sup>	T <sub>C</sub> =25°C	42
		T <sub>C</sub> =70°C	27
T <sub>J</sub> , T <sub>STG</sub>	Operating Junction and Storage Temperature Range	-55 to 150	°C

**THERMAL CHARACTERISTICS**

R <sub>θJC</sub>	Thermal Resistance, Junction-to-Case <sup>a</sup>	3	°C/W
R <sub>θJA</sub>	Thermal Resistance, Junction-to-Ambient <sup>a</sup>	50	°C/W

# STU/D449S

Ver 1.0

## ELECTRICAL CHARACTERISTICS (T<sub>A</sub>=25°C unless otherwise noted)

Symbol	Parameter	Conditions	Min	Typ	Max	Units
<b>OFF CHARACTERISTICS</b>						
BV <sub>DSS</sub>	Drain-Source Breakdown Voltage	V <sub>GS</sub> =0V , I <sub>D</sub> =-250uA	-40			V
I <sub>DSS</sub>	Zero Gate Voltage Drain Current	V <sub>DS</sub> =-32V , V <sub>GS</sub> =0V			1	uA
I <sub>GSS</sub>	Gate-Body Leakage Current	V <sub>GS</sub> = ±20V , V <sub>DS</sub> =0V			±100	nA
<b>ON CHARACTERISTICS</b>						
V <sub>GS(th)</sub>	Gate Threshold Voltage	V <sub>DS</sub> =V <sub>GS</sub> , I <sub>D</sub> =-250uA	-2	-2.5	-4	V
R <sub>DS(ON)</sub>	Drain-Source On-State Resistance	V <sub>GS</sub> =-10V , I <sub>D</sub> =-12A		33	41	m ohm
		V <sub>GS</sub> =-4.5V , I <sub>D</sub> =-9A		57	74	m ohm
g <sub>FS</sub>	Forward Transconductance	V <sub>DS</sub> =-10V , I <sub>D</sub> =-12A		24		S
<b>DYNAMIC CHARACTERISTICS <sup>c</sup></b>						
C <sub>ISS</sub>	Input Capacitance	V <sub>DS</sub> =-20V, V <sub>GS</sub> =0V f=1.0MHz		900		pF
C <sub>OSS</sub>	Output Capacitance			115		pF
C <sub>RSS</sub>	Reverse Transfer Capacitance			90		pF
<b>SWITCHING CHARACTERISTICS <sup>c</sup></b>						
t <sub>D(ON)</sub>	Turn-On Delay Time	V <sub>DD</sub> =-20V I <sub>D</sub> =-1A V <sub>GS</sub> =-10V R <sub>GEN</sub> = 6 ohm		21		ns
t <sub>r</sub>	Rise Time			20		ns
t <sub>D(OFF)</sub>	Turn-Off Delay Time			51		ns
t <sub>f</sub>	Fall Time			20		ns
Q <sub>g</sub>	Total Gate Charge	V <sub>DS</sub> =-20V, I <sub>D</sub> =-12A, V <sub>GS</sub> =-10V		20		nC
		V <sub>DS</sub> =-20V, I <sub>D</sub> =-12A, V <sub>GS</sub> =-4.5V		9.5		nC
Q <sub>gs</sub>	Gate-Source Charge	V <sub>DS</sub> =-20V, I <sub>D</sub> =-12A, V <sub>GS</sub> =-10V		2.5		nC
Q <sub>gd</sub>	Gate-Drain Charge			5.5		nC
<b>DRAIN-SOURCE DIODE CHARACTERISTICS AND MAXIMUM RATINGS</b>						
V <sub>SD</sub>	Diode Forward Voltage <sup>b</sup>	V <sub>GS</sub> =0V, I <sub>S</sub> = -2A		-0.8	-1.3	V

### Notes

- Surface Mounted on FR4 Board, t ≤ 10sec.
- Pulse Test: Pulse Width ≤ 300us, Duty Cycle ≤ 2%.
- Guaranteed by design, not subject to production testing.
- Starting T<sub>J</sub>=25°C, L=0.5mH, V<sub>DD</sub> = -20V. (See Figure13)

Apr,01,2010

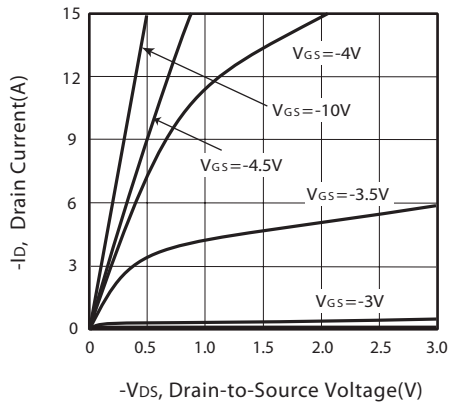

Figure 1. Output Characteristics

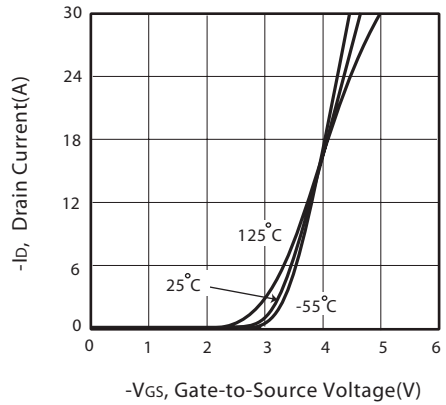

Figure 2. Transfer Characteristics

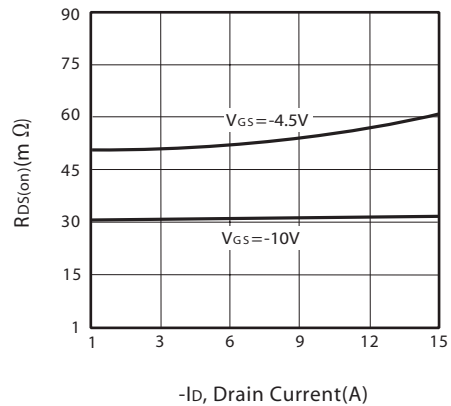

Figure 3. On-Resistance vs. Drain Current and Gate Voltage

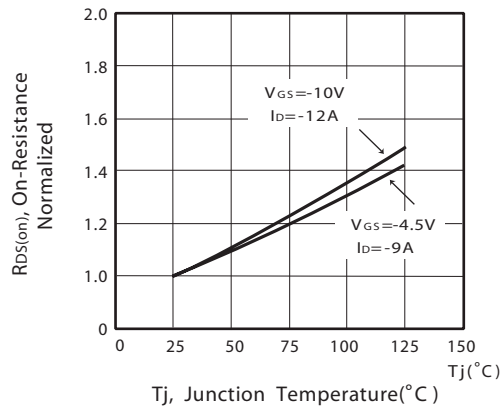

Figure 4. On-Resistance Variation with Drain Current and Temperature

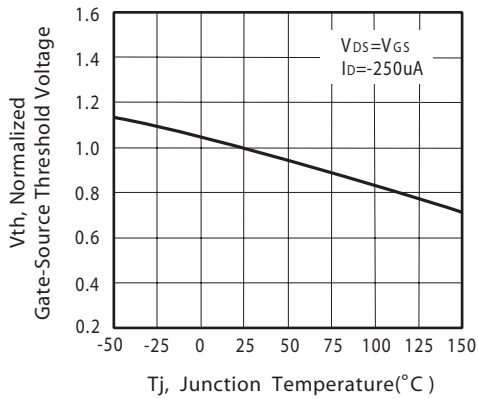

Figure 5. Gate Threshold Variation with Temperature

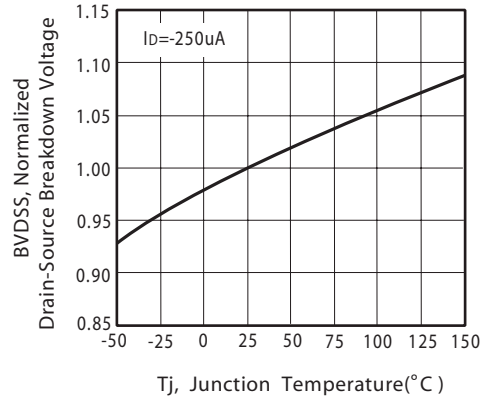

Figure 6. Breakdown Voltage Variation with Temperature

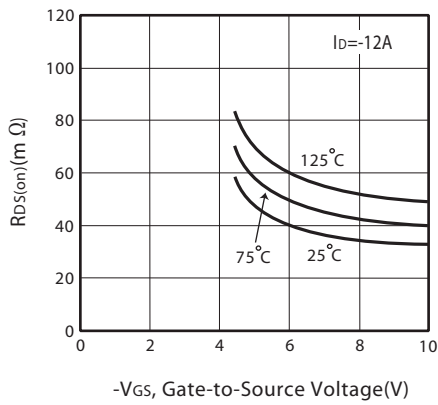

Figure 7. On-Resistance vs. Gate-Source Voltage

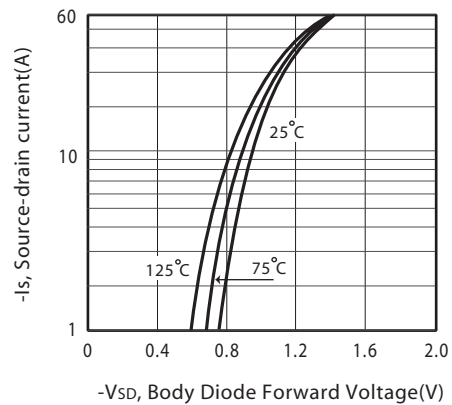

Figure 8. Body Diode Forward Voltage Variation with Source Current

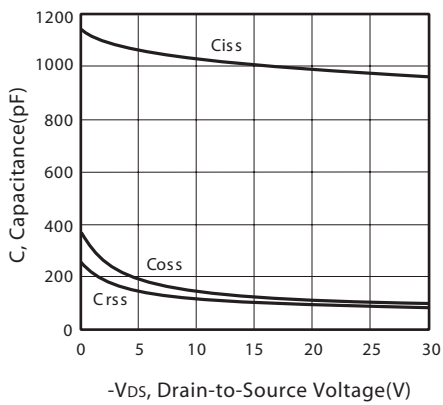

Figure 9. Capacitance

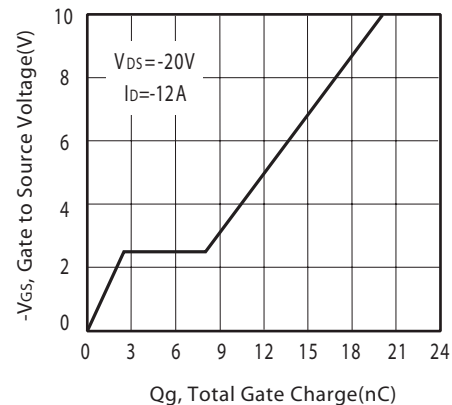

Figure 10. Gate Charge

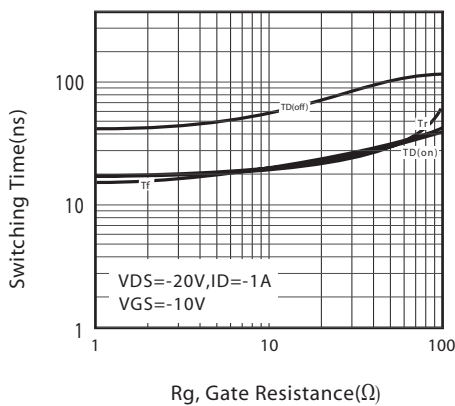

Figure 11. switching characteristics

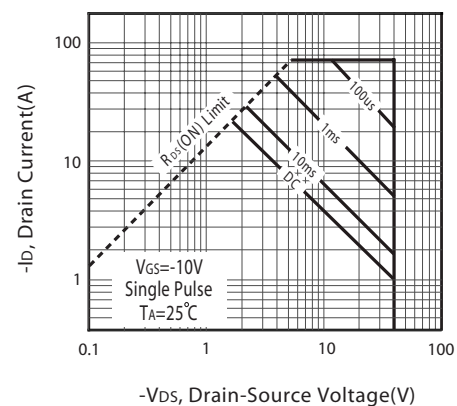
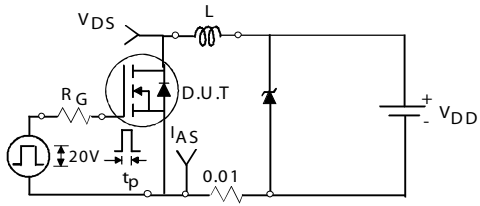
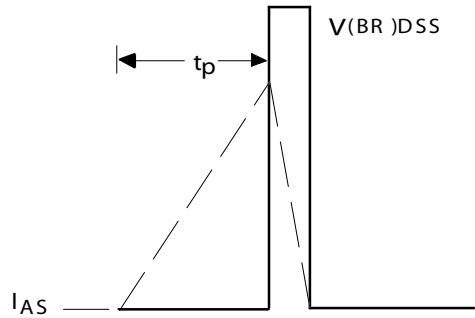

Figure 12. Maximum Safe Operating Area



Unclamped Inductive Test Circuit

Figure 13a.



Unclamped Inductive Waveforms

Figure 13b.

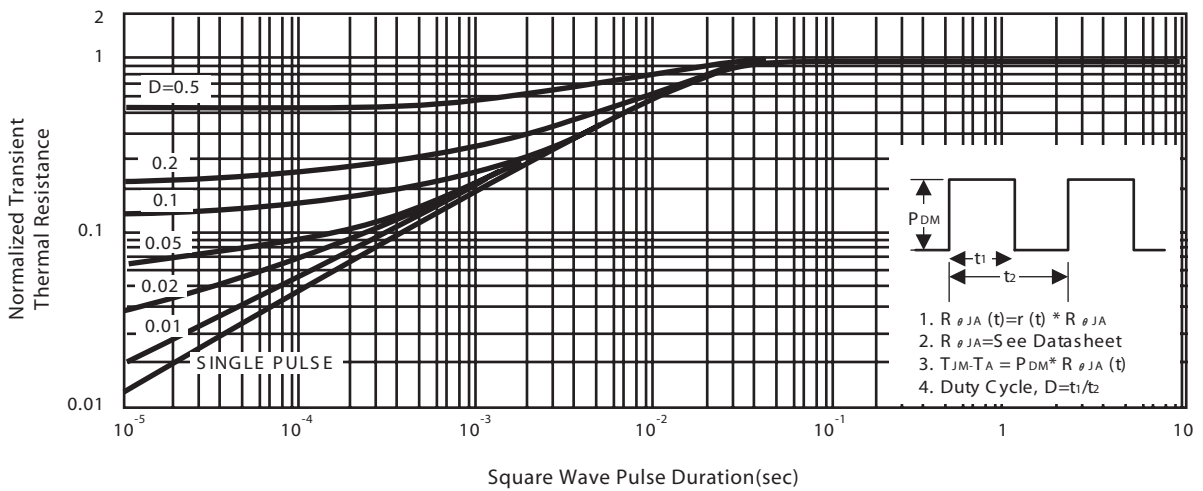
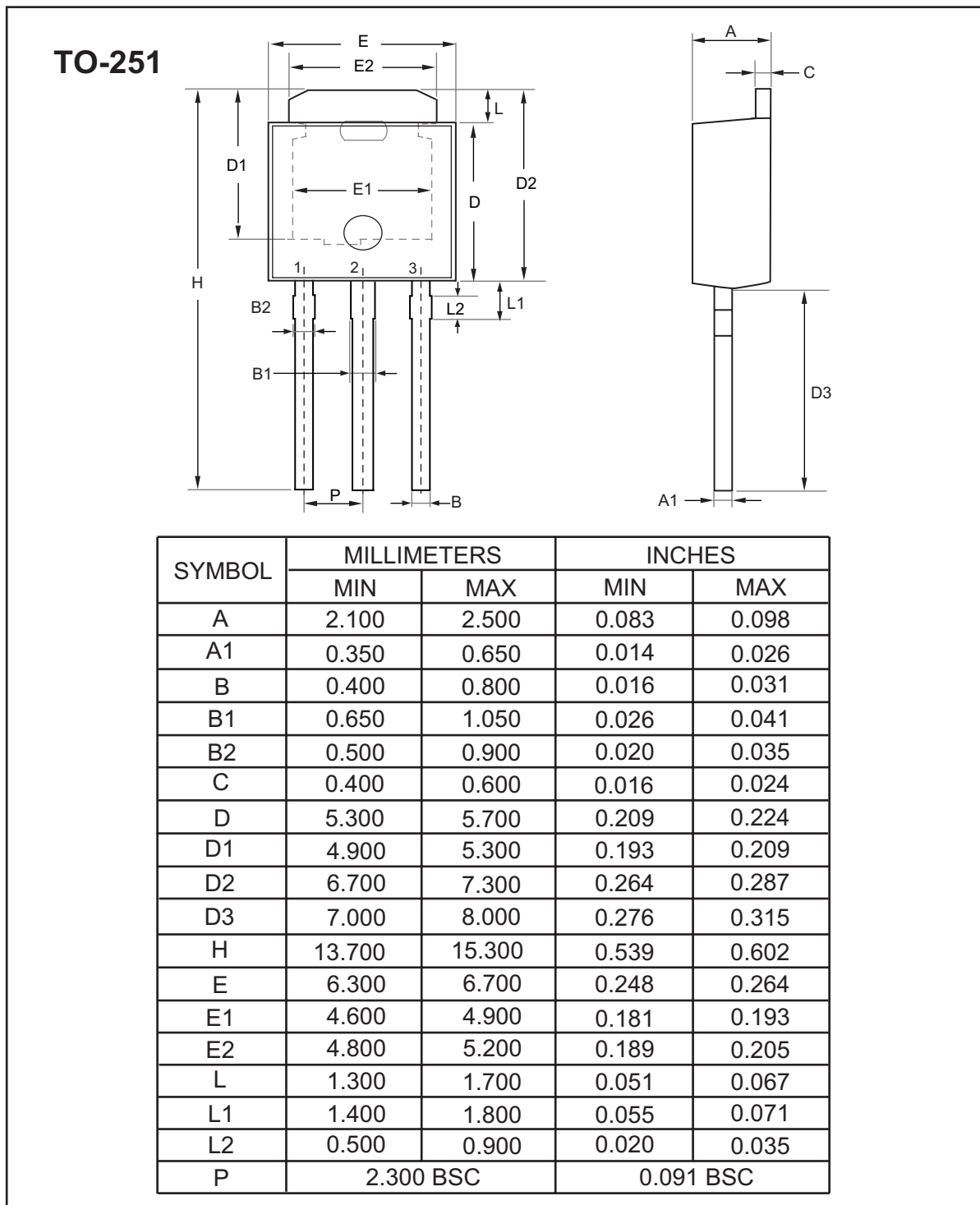
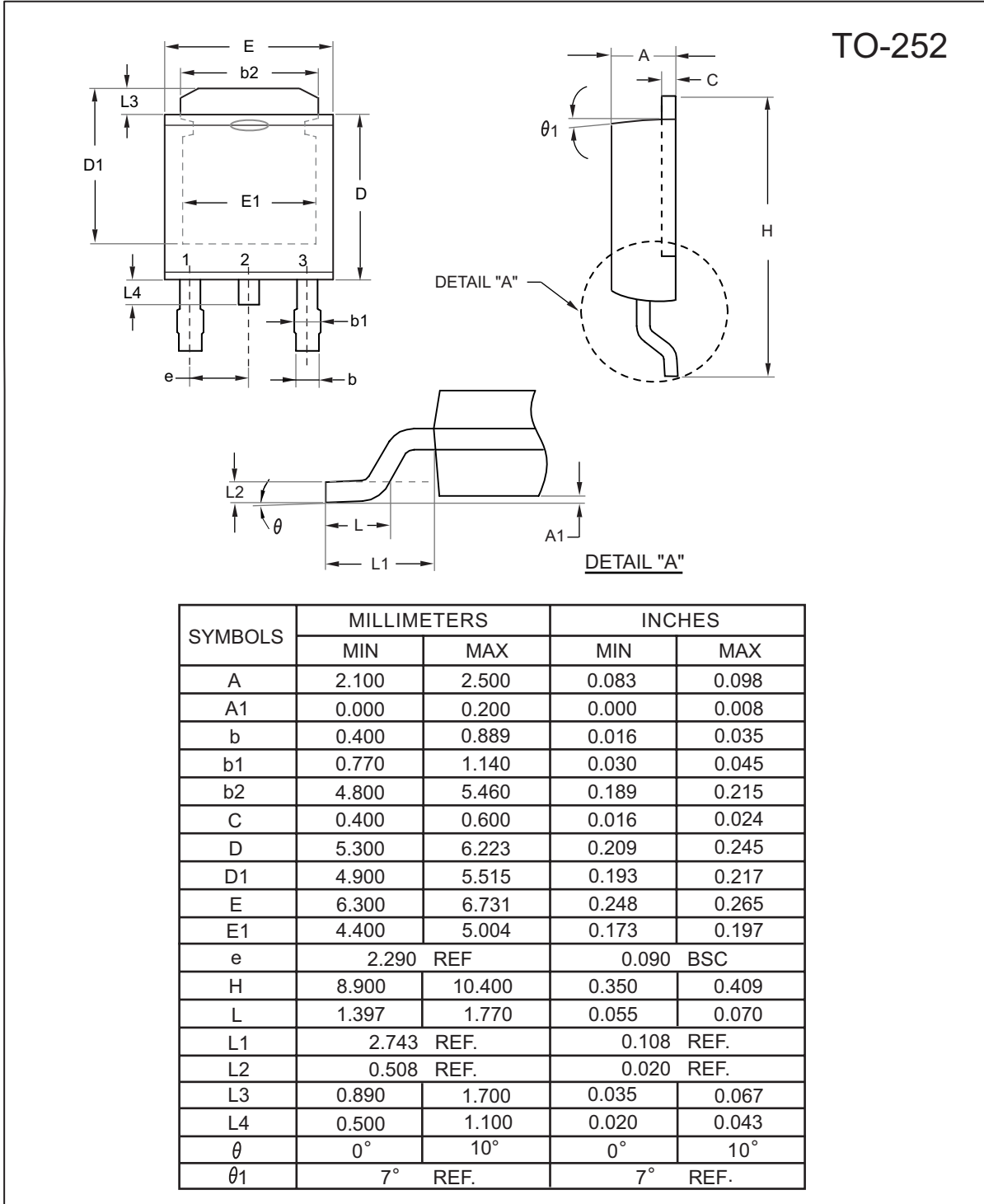

Figure 14. Normalized Thermal Transient Impedance Curve

## PACKAGE OUTLINE DIMENSIONS





## TO-251 Tube/TO-252 Tape and Reel Data

### TO-251 Tube

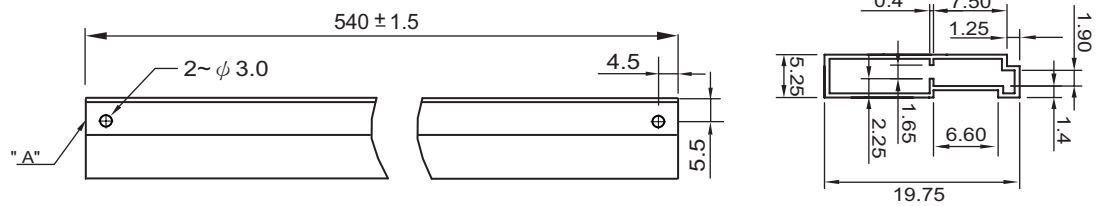

### TO-252 Carrier Tape

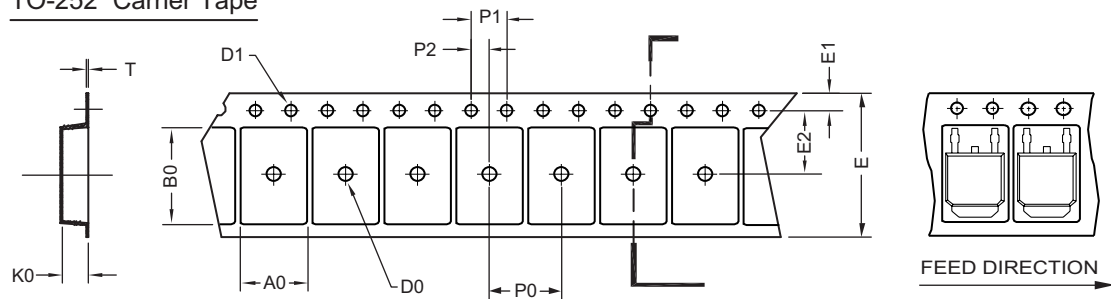

UNIT:mm

PACKAGE	A0	B0	K0	D0	D1	E	E1	E2	P0	P1	P2	T
TO-252 (16 mm)	6.96 ±0.1	10.49 ±0.1	2.79 ±0.1	φ 2	φ 1.5 + 0.1 - 0	16.0 ±0.3	1.75 ±0.1	7.5 ±0.15	8.0 ±0.1	4.0 ±0.1	2.0 ±0.15	0.3 ±0.05

### TO-252 Reel

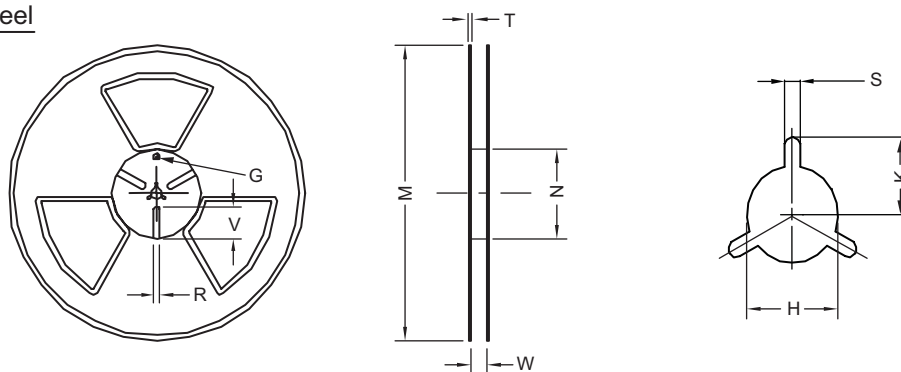

UNIT:mm

TAPE SIZE	REEL SIZE	M	N	W	T	H	K	S	G	R	V
16 mm	φ 330	φ 330 ± 0.5	φ 97 ± 1.0	17.0 + 1.5 - 0	2.2	φ 13.0 + 0.5 - 0.2	10.6	2.0 ±0.5	---	---	---