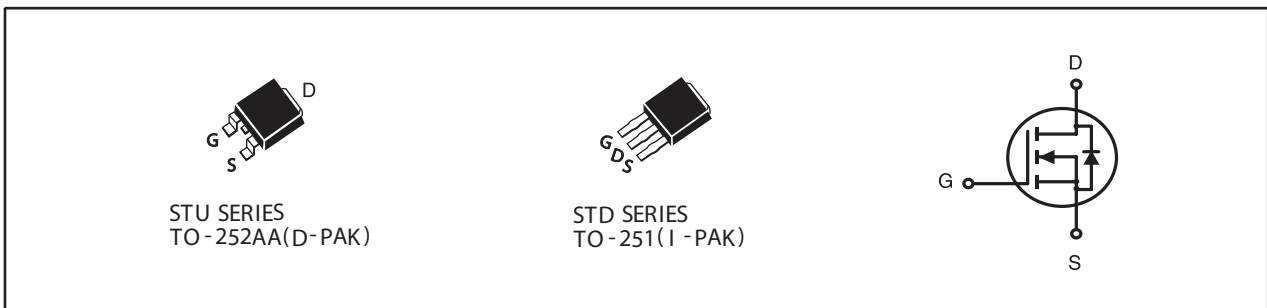

**N-Channel Logic Level Enhancement Mode Field Effect Transistor****PRODUCT SUMMARY**

V _{DSS}	I _D	R _{DS(ON)} (mΩ) Typ
100V	40A	18 @ V _{GS} =10V

FEATURES

- Super high dense cell design for low R_{DS(ON)}.
- Rugged and reliable.
- TO-252 and TO-251 Package.

**ABSOLUTE MAXIMUM RATINGS (T_C=25°C unless otherwise noted)**

Symbol	Parameter	Limit	Units
V _{DS}	Drain-Source Voltage	100	V
V _{GS}	Gate-Source Voltage	±20	V
I _D	Drain Current-Continuous ^{a e}	T _C =25°C	40
		T _C =70°C	33.5
I _{DM}	-Pulsed ^b	117	A
E _{AS}	Single Pulse Avalanche Energy ^d	306	mJ
P _D	Maximum Power Dissipation	T _C =25°C	60
		T _C =70°C	42
T _J , T _{STG}	Operating Junction and Storage Temperature Range	-55 to 175	°C

THERMAL CHARACTERISTICS

R _{θ JC}	Thermal Resistance, Junction-to-Case	2.5	°C/W
R _{θ JA}	Thermal Resistance, Junction-to-Ambient	50	°C/W

STU45N01

STD45N01

Ver 1.0

ELECTRICAL CHARACTERISTICS (T_C=25°C unless otherwise noted)

Symbol	Parameter	Conditions	Min	Typ	Max	Units
OFF CHARACTERISTICS						
BV _{DSS}	Drain-Source Breakdown Voltage	V _{GS} =0V , I _D =250uA	100			V
I _{DSS}	Zero Gate Voltage Drain Current	V _{DS} =80V , V _{GS} =0V			1	uA
I _{GSS}	Gate-Body Leakage Current	V _{GS} = ±20V , V _{DS} =0V			±100	nA
ON CHARACTERISTICS						
V _{GS(th)}	Gate Threshold Voltage	V _{DS} =V _{GS} , I _D =250uA	1	2	3	V
R _{DS(ON)}	Drain-Source On-State Resistance	V _{GS} =10V , I _D =20A		18	23	m ohm
g _{FS}	Forward Transconductance	V _{DS} =10V , I _D =20A		17		S
DYNAMIC CHARACTERISTICS ^c						
C _{ISS}	Input Capacitance	V _{DS} =25V, V _{GS} =0V f=1.0MHz		2560		pF
C _{OSS}	Output Capacitance			247		pF
C _{RSS}	Reverse Transfer Capacitance			180		pF
SWITCHING CHARACTERISTICS ^c						
t _{D(ON)}	Turn-On Delay Time	V _{DD} =50V I _D =1A V _{GS} =10V R _{GEN} = 6 ohm		54		ns
t _r	Rise Time			73		ns
t _{D(OFF)}	Turn-Off Delay Time			78		ns
t _f	Fall Time			40		ns
Q _g	Total Gate Charge	V _{DS} =50V, I _D =20A, V _{GS} =10V		32		nC
Q _{gs}	Gate-Source Charge	V _{DS} =50V, I _D =20A, V _{GS} =10V		4		nC
Q _{gd}	Gate-Drain Charge			16		nC
DRAIN-SOURCE DIODE CHARACTERISTICS AND MAXIMUM RATINGS						
V _{SD}	Diode Forward Voltage	V _{GS} =0V, I _S =6A		0.78	1.3	V
Notes						
<p>a.Surface Mounted on FR4 Board, t ≤ 10sec.</p> <p>b.Pulse Test:Pulse Width ≤ 300us, Duty Cycle ≤ 2%.</p> <p>c.Guaranteed by design, not subject to production testing.</p> <p>d.Starting T_J=25°C, L=0.5mH, V_{DD} = 50V.(See Figure13)</p> <p>e.Drain current limited by maximum junction temperature.</p>						

Aug,05,2013

STU45N01 STD45N01

Ver 1.0

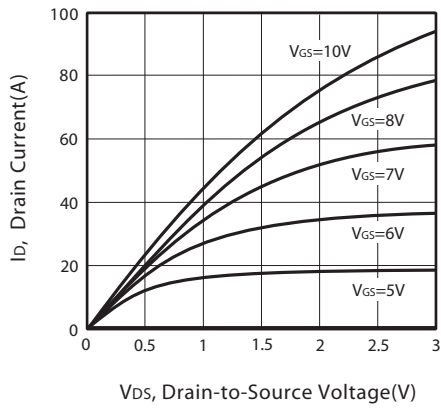

Figure 1. Output Characteristics

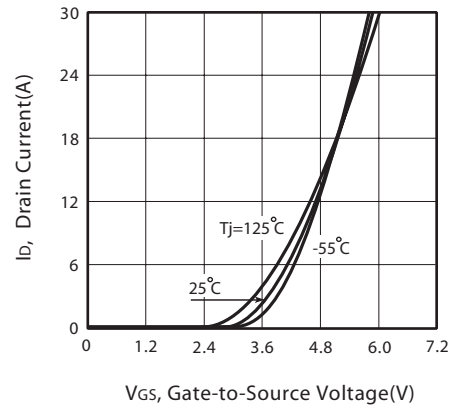

Figure 2. Transfer Characteristics

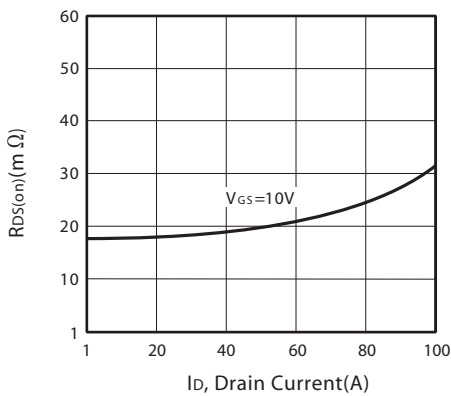

Figure 3. On-Resistance vs. Drain Current and Gate Voltage

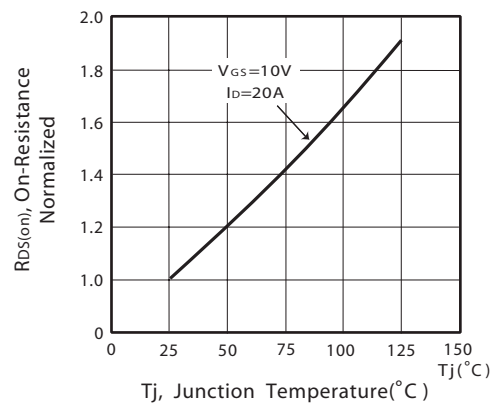

Figure 4. On-Resistance Variation with Drain Current and Temperature

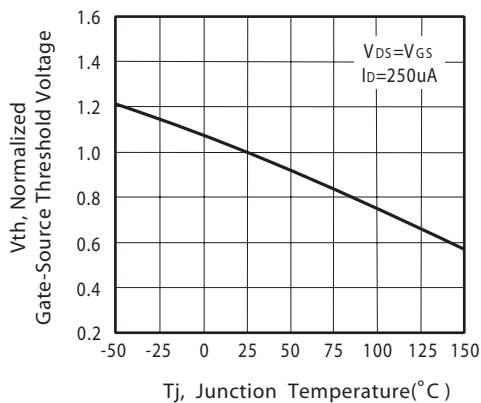

Figure 5. Gate Threshold Variation with Temperature

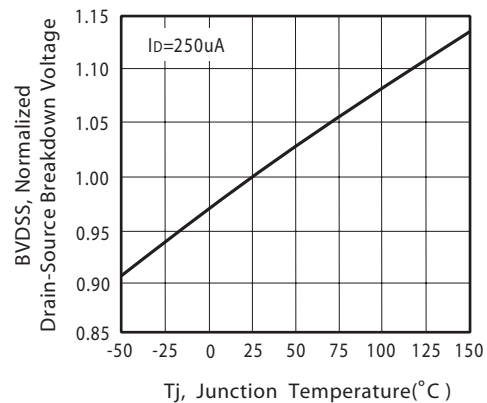

Figure 6. Breakdown Voltage Variation with Temperature

Aug,05,2013

STU45N01 STD45N01

Ver 1.0

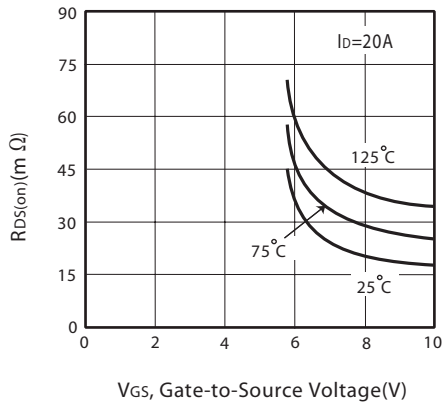

Figure 7. On-Resistance vs. Gate-Source Voltage

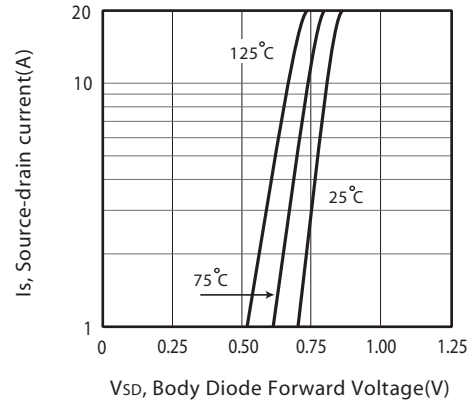

Figure 8. Body Diode Forward Voltage Variation with Source Current

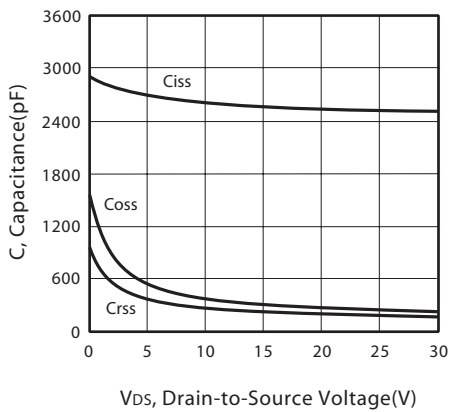

Figure 9. Capacitance

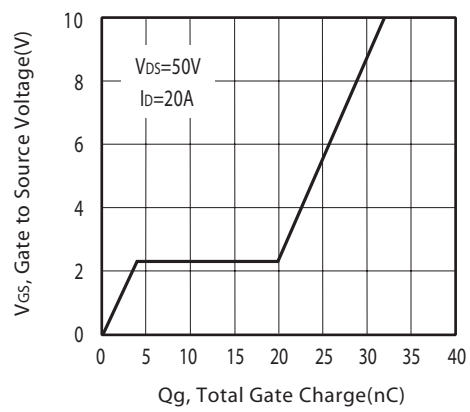

Figure 10. Gate Charge

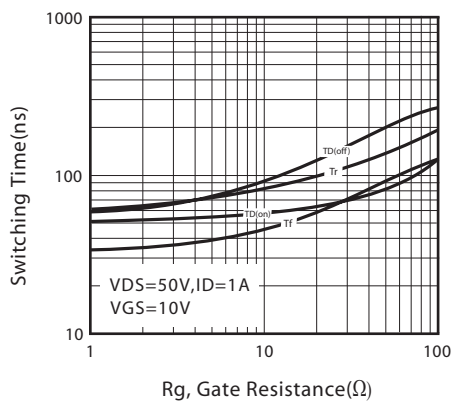

Figure 11. switching characteristics

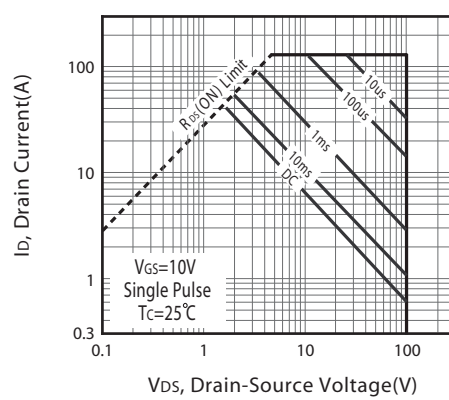
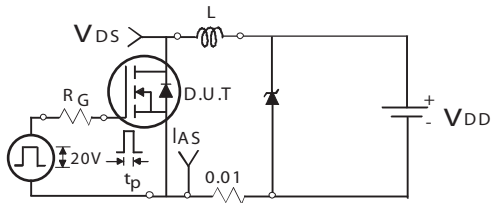

Figure 12. Maximum Safe Operating Area

Aug,05,2013

STU45N01 STD45N01

Ver 1.0



Unclamped Inductive Test Circuit

Figure 13a.

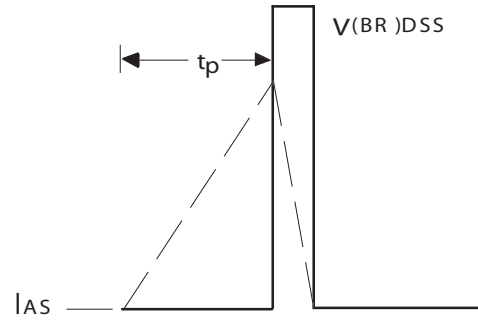

Unclamped Inductive Waveforms

Figure 13b.

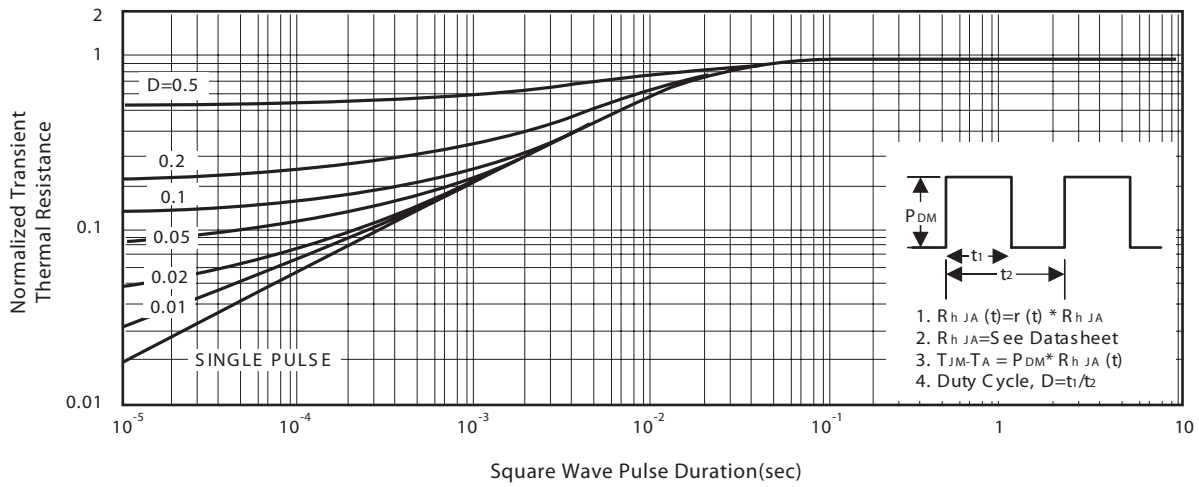
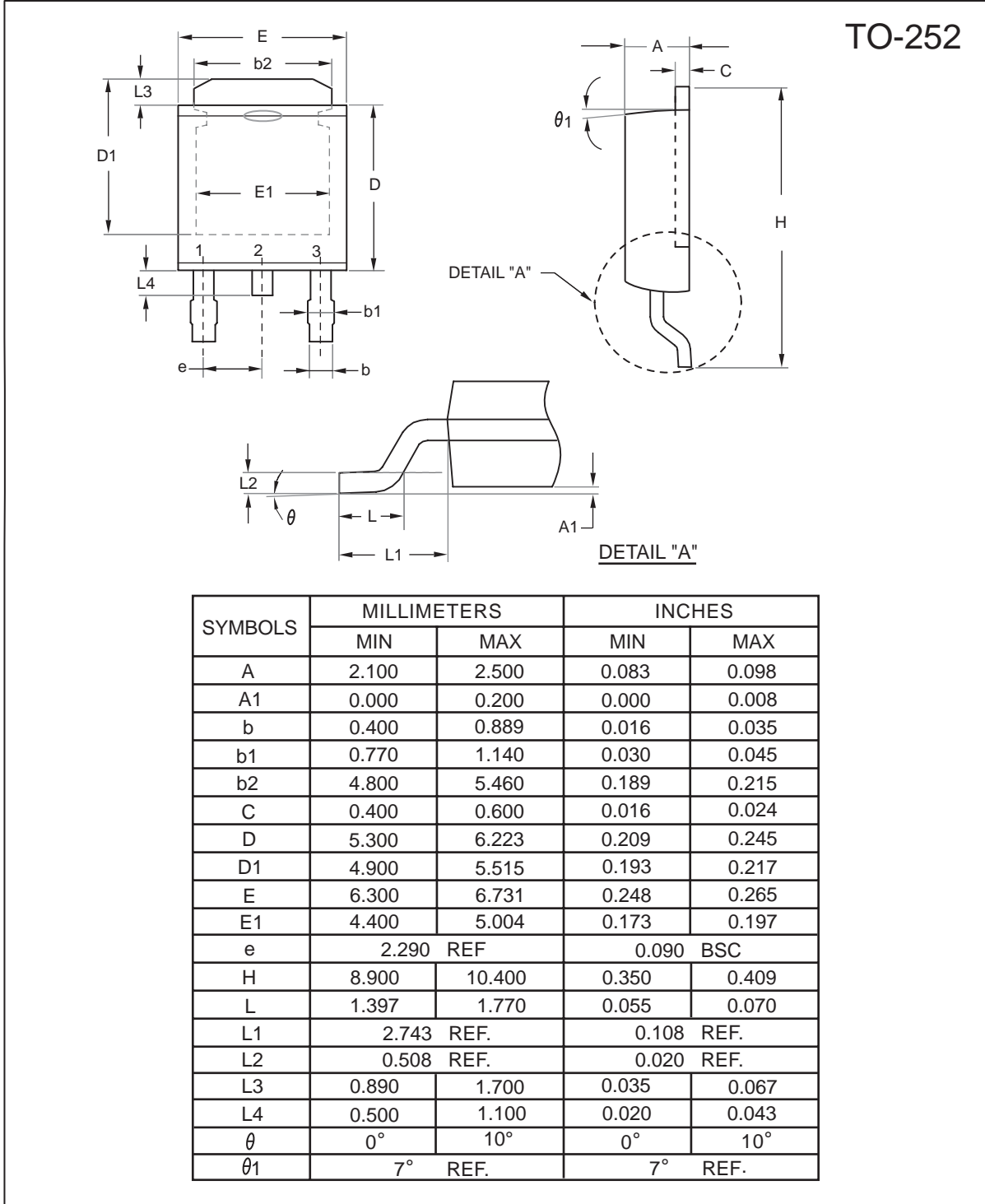

Figure 14. Normalized Thermal Transient Impedance Curve

Aug.05,2013

STU45N01 STD45N01

Ver 1.0



Aug.05,2013

STU45N01 STD45N01

Ver 1.0

PACKAGE OUTLINE DIMENSIONS

TO-251

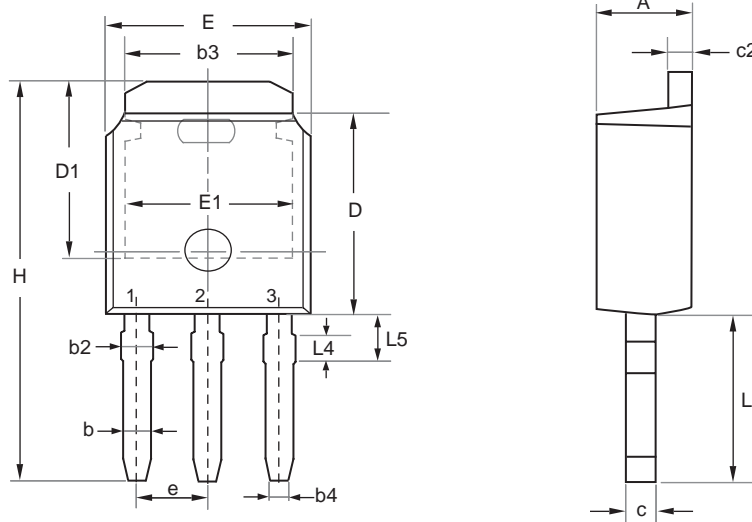

SYMBOL	MILLIMETERS		INCHES	
	MIN	MAX	MIN	MAX
E	6.400	6.731	0.252	0.265
L	3.980	4.280	0.157	0.169
L4	0.698 REF		0.027 REF	
L5	0.972	1.226	0.038	0.048
D	6.000	6.223	0.236	0.245
H	11.050	11.450	0.435	0.450
b	0.640	0.880	0.025	0.035
b2	0.770	1.140	0.030	0.045
b3	5.210	5.460	0.205	0.215
b4	0.450	0.550	0.018	0.022
e	2.286 BSC		0.090 BSC	
A	2.200	2.380	0.087	0.094
c	0.400	0.600	0.016	0.024
c2	0.400	0.600	0.016	0.024
D1	5.100	---	0.201	---
E1	4.400	---	0.173	---

Aug,05,2013

STU45N01 STD45N01

Ver 1.0

TO-251 Tube/TO-252 Tape and Reel Data

TO-251 Tube

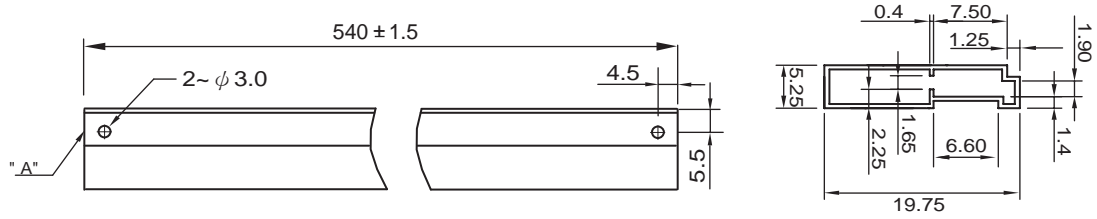

TO-252 Carrier Tape

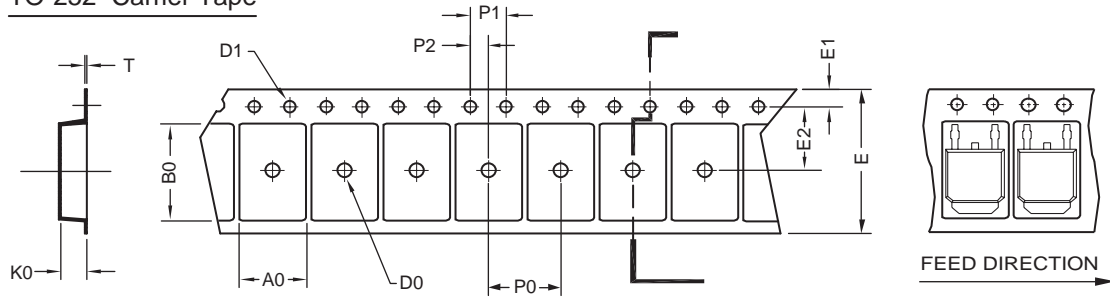

UNIT:mm

PACKAGE	A0	B0	K0	D0	D1	E	E1	E2	P0	P1	P2	T
TO-252 (16 mm)	6.96 ± 0.1	10.49 ± 0.1	2.79 ± 0.1	$\phi 2$	$\phi 1.5$ $+0.1$ -0	16.0 ± 0.3	1.75 ± 0.1	7.5 ± 0.15	8.0 ± 0.1	4.0 ± 0.1	2.0 ± 0.15	0.3 ± 0.05

TO-252 Reel

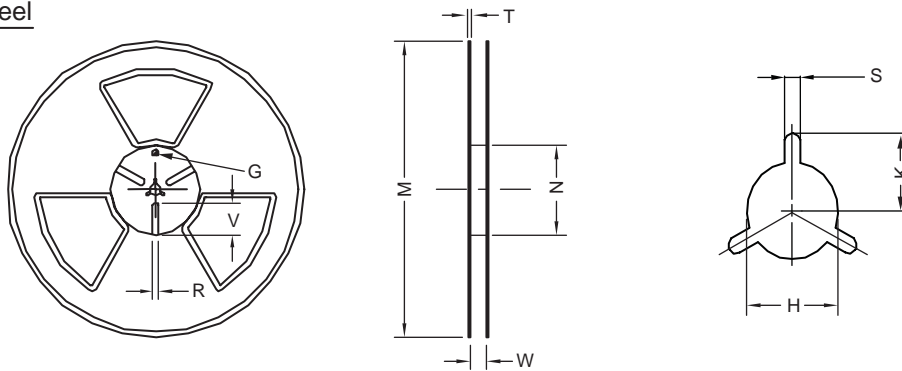

UNIT:mm

TAPE SIZE	REEL SIZE	M	N	W	T	H	K	S	G	R	V
16 mm	$\phi 330$	$\phi 330$ ± 0.5	$\phi 97$ ± 1.0	17.0 $+1.5$ -0	2.2	$\phi 13.0$ $+0.5$ -0.2	10.6	2.0 ± 0.5	---	---	---

Aug,05,2013

STU45N01 STD45N01

Ver 1.0

TOP MARKING DEFINITION

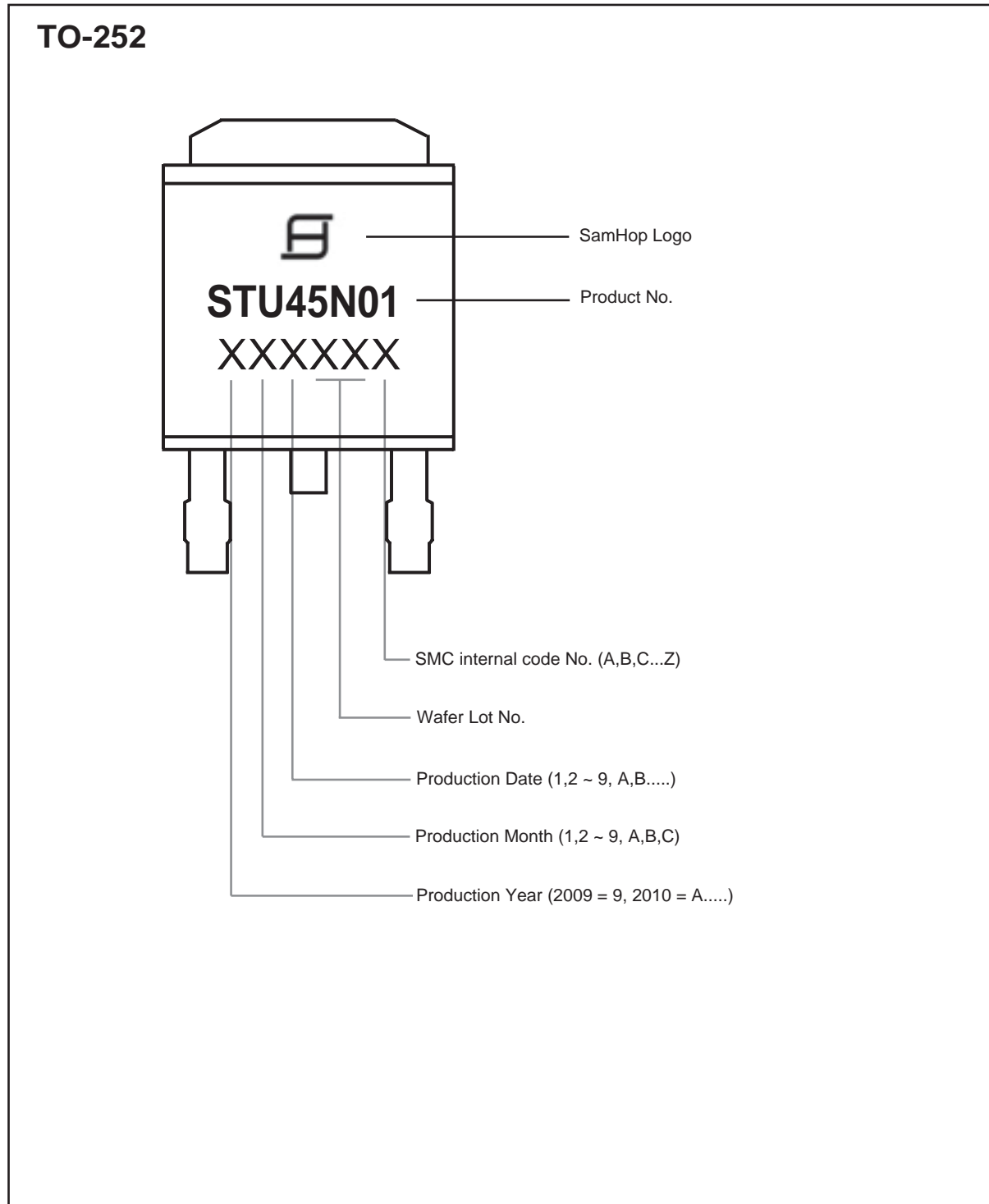

Aug,05,2013

STU45N01 STD45N01

Ver 1.0

TOP MARKING DEFINITION

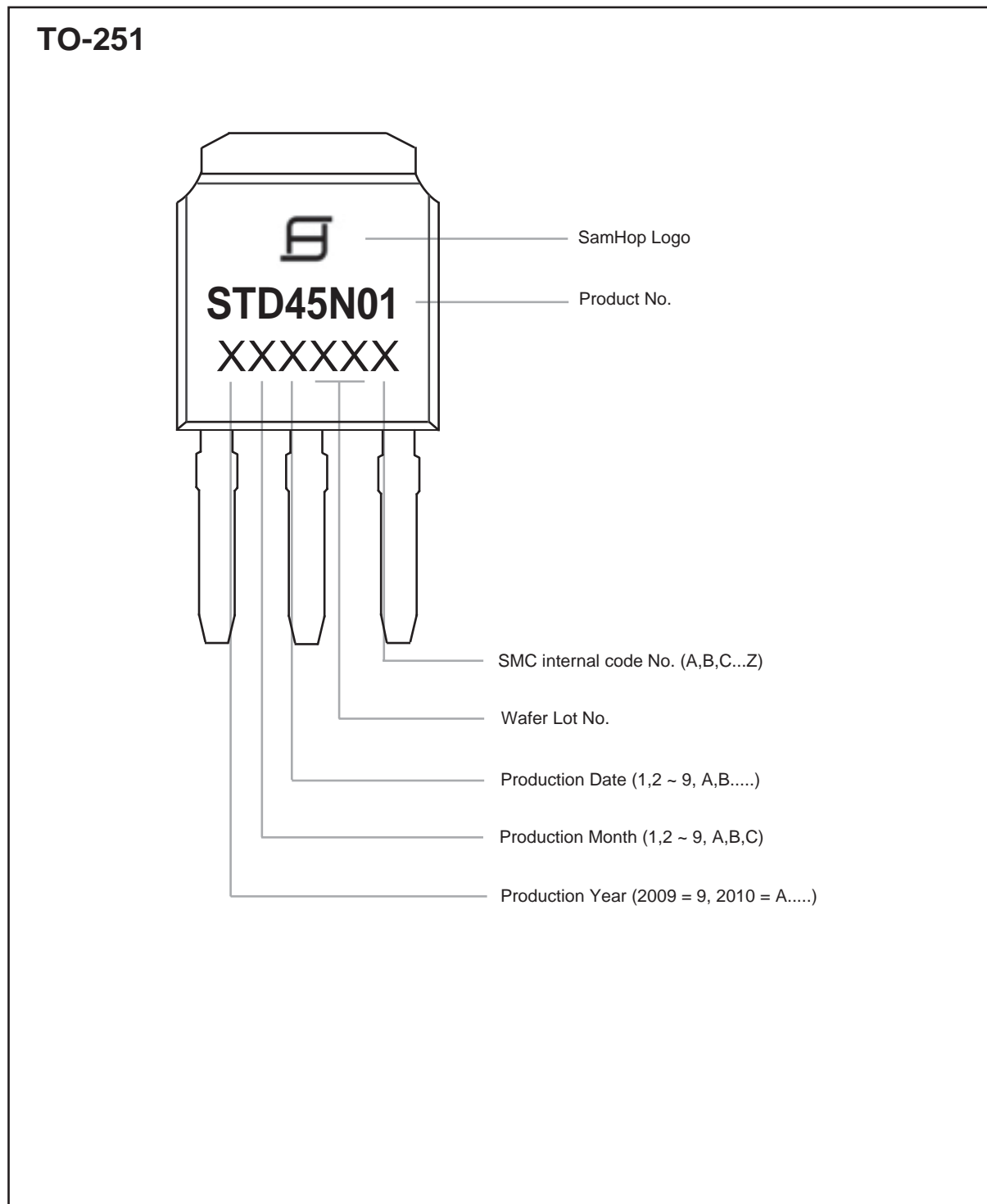

Aug,05,2013