



STU/D600S

SamHop Microelectronics Corp.

Aug 25,2006

N-Channel Enhancement Mode Field Effect Transistor

PRODUCT SUMMARY

V _{DSS}	I _D	R _{DS(ON)} (mΩ) Max
60V	16A	55 @ V _{GS} = 10V
		70 @ V _{GS} = 4.5V

FEATURES

- Super high dense cell design for low R_{DS(ON)}.
- Rugged and reliable.
- TO-252 and TO-251 Package.

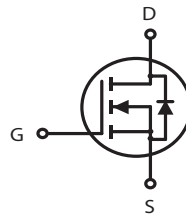

ABSOLUTE MAXIMUM RATINGS (T_A=25 C unless otherwise noted)

Parameter	Symbol	Limit	Unit	
Drain-Source Voltage	V _{DS}	60	V	
Gate-Source Voltage	V _{GS}	±20	V	
Drain Current-Continuous ^a @T _a	I _D	25 °C	16	A
		70 °C	10.7	A
-Pulsed ^b	I _{DM}	30	A	
Drain-Source Diode Forward Current ^a	I _S	15	A	
Maximum Power Dissipation ^a	P _D	T _a = 25 °C	50	W
		T _a =70 °C	35	
Operating Junction and Storage Temperature Range	T _J , T _{STG}	-55 to 175	°C	

THERMAL CHARACTERISTICS

Thermal Resistance, Junction-to-Case	R _{θC}	3	°C/W
Thermal Resistance, Junction-to-Ambient	R _{θA}	50	°C/W

STU/D600S

N-Channel ELECTRICAL CHARACTERISTICS ($T_A = 25\text{ }^\circ\text{C}$ unless otherwise noted)

Parameter	Symbol	Condition	Min	Typ ^c	Max	Unit
OFF CHARACTERISTICS						
Drain-Source Breakdown Voltage	BV_{DSS}	$V_{GS}=0V, I_D=250\mu A$	60			V
Zero Gate Voltage Drain Current	I_{DSS}	$V_{DS}=48V, V_{GS}=0V$			1	μA
Gate-Body Leakage	I_{GSS}	$V_{GS}=\pm 20V, V_{DS}=0V$			± 100	nA
ON CHARACTERISTICS^b						
Gate Threshold Voltage	$V_{GS(th)}$	$V_{DS}=V_{GS}, I_D=250\mu A$	1.0	1.8	3.0	V
Drain-Source On-State Resistance	$R_{DS(on)}$	$V_{GS}=10V, I_D=8A$		45	55	m ohm
		$V_{GS}=4.5V, I_D=4A$		50	70	m ohm
On-State Drain Current	$I_{D(on)}$	$V_{DS}=5V, V_{GS}=10V$	20			A
Forward Transconductance	g_{FS}	$V_{DS}=10V, I_D=8A$		16		S
DYNAMIC CHARACTERISTICS^c						
Input Capacitance	C_{iss}	$V_{DS}=30V, V_{GS}=0V$ $f=1.0MHz$		670		pF
Output Capacitance	C_{oss}			72		pF
Reverse Transfer Capacitance	C_{riss}			45		pF
Gate resistance	R_g	$V_{GS}=0V, V_{DS}=0V, f=1.0MHz$		3.2		ohm
SWITCHING CHARACTERISTICS^c						
Turn-On Delay Time	$t_{D(on)}$	$V_{DD}=30V$ $I_D=8A$ $V_{GS}=10V$ $R_{GEN}=3.3\text{ ohm}$		13		ns
Rise Time	t_r			10		ns
Turn-Off Delay Time	$t_{D(off)}$			25		ns
Fall Time	t_f			9		ns
Total Gate Charge	Q_g	$V_{DS}=30V, I_D=8A, V_{GS}=10V$		14.2		nC
		$V_{DS}=30V, I_D=8A, V_{GS}=4.5V$		7		nC
Gate-Source Charge	Q_{gs}	$V_{DS}=30V, I_D=8A$		1.7		nC
Gate-Drain Charge	Q_{gd}	$V_{GS}=10V$		3.8		nC

STU/D600S

ELECTRICAL CHARACTERISTICS ($T_c=25^{\circ}\text{C}$ unless otherwise noted)

Parameter	Symbol	Condition	Min	Typ	Max	Unit
DRAIN-SOURCE DIODE CHARACTERISTICS ^a						
Diode Forward Voltage	V_{SD}	$V_{GS} = 0V, I_s = 10A$		0.9	1.3	V

Notes

- a. Pulse Test: Pulse Width $\leq 300\mu s$, Duty Cycle $\leq 2\%$.
- b. Guaranteed by design, not subject to production testing.

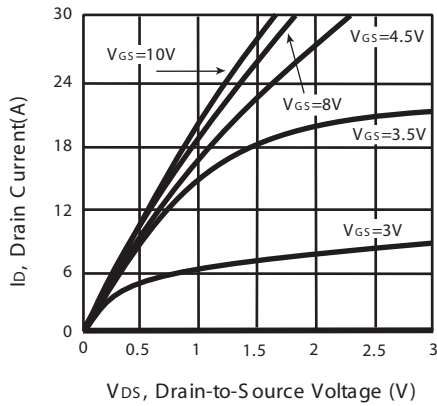

Figure 1. Output Characteristics

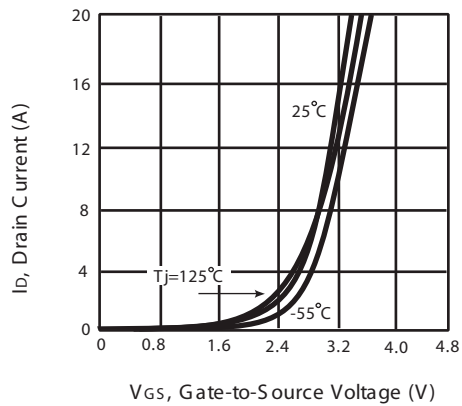

Figure 2. Transfer Characteristics

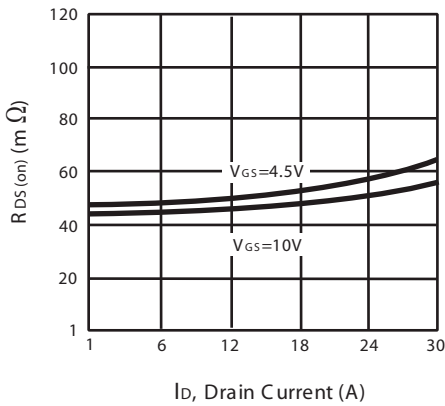

Figure 3. On-Resistance vs. Drain Current and Gate Voltage

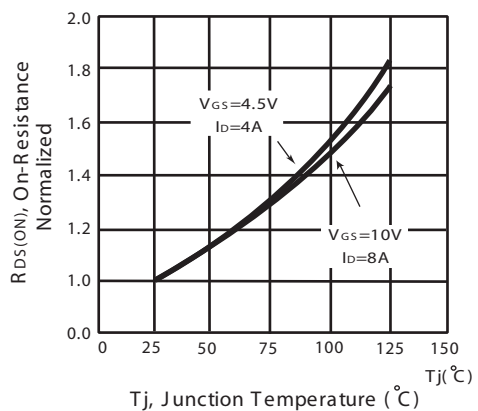

Figure 4. On-Resistance Variation with Drain Current and Temperature

STU/D600S

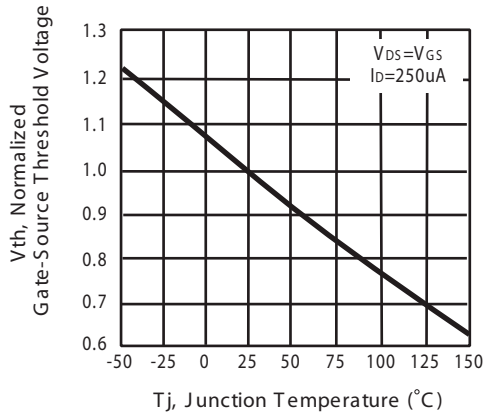

Figure 5. Gate Threshold Variation with Temperature

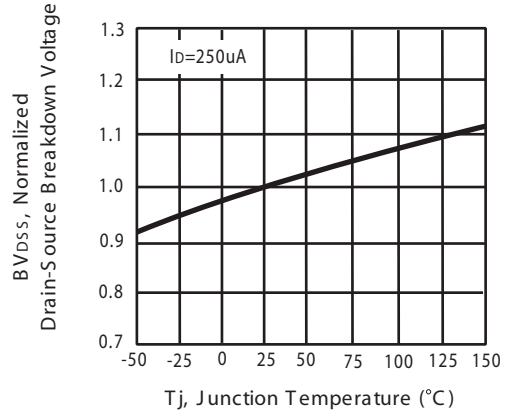

Figure 6. Breakdown Voltage Variation with Temperature

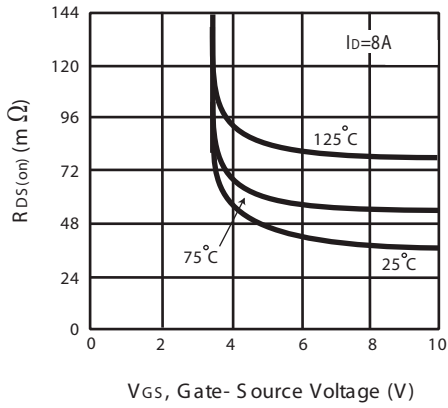

Figure 7. On-Resistance vs. Gate-Source Voltage

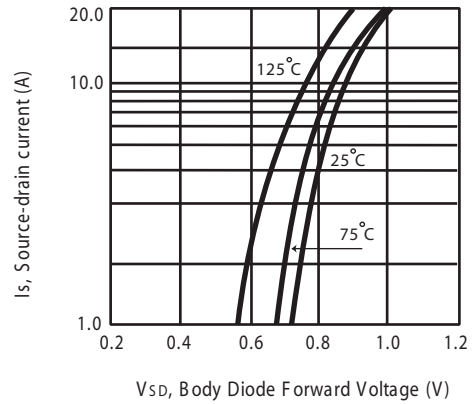

Figure 8. Body Diode Forward Voltage Variation with Source Current

STU/D600S

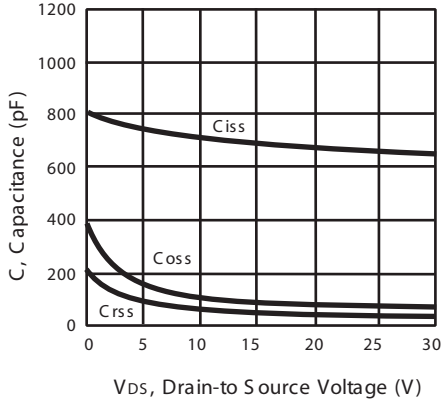

Figure 9. Capacitance

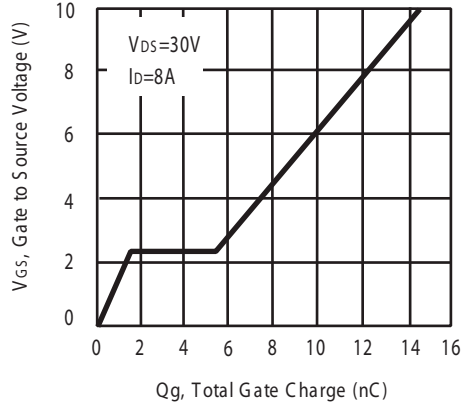

Figure 10. Gate Charge

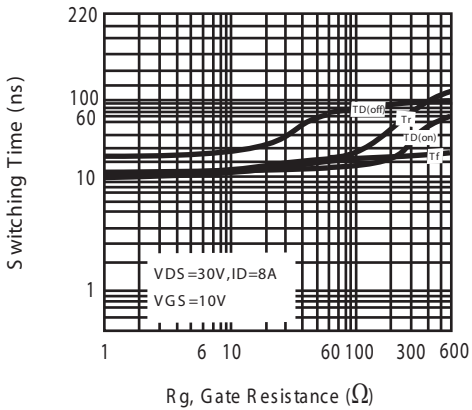

Figure 11. switching characteristics

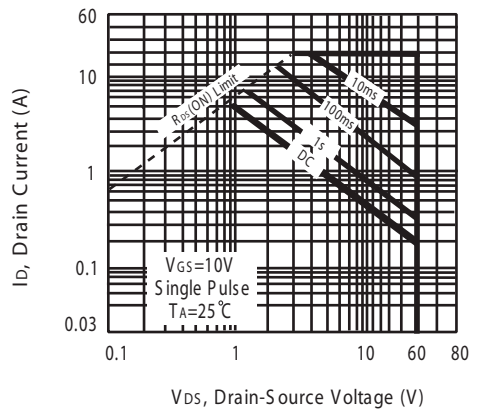

Figure 12. Maximum Safe Operating Area

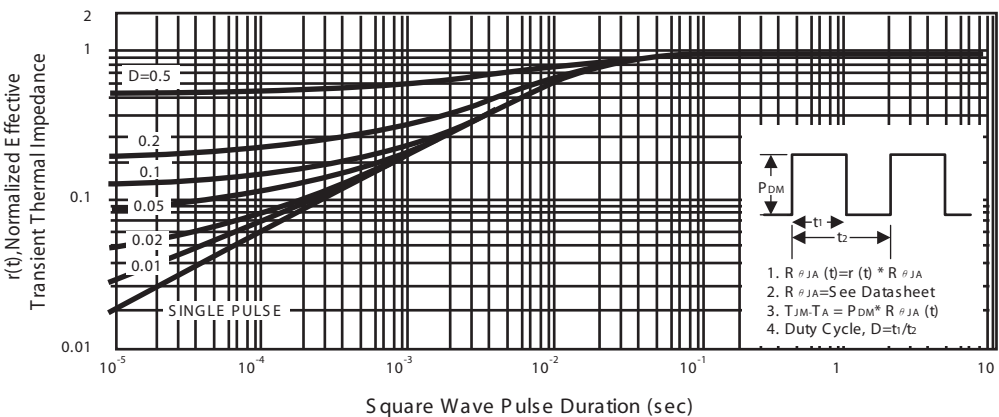
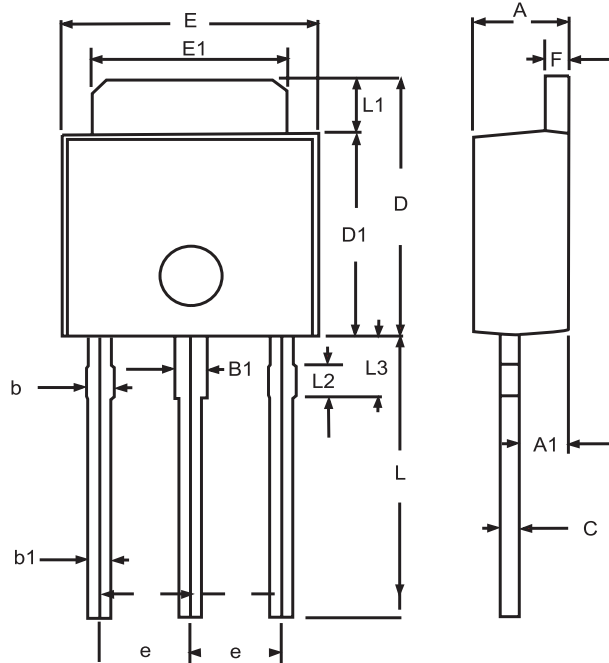

Figure 13. Normalized Thermal Transient Impedance Curve

STU/D600S

PACKAGE OUTLINE DIMENSIONS

TO-251



SYMBOLS	MILLIMETERS		INCHES	
	MIN	MAX	MIN	MAX
A	2.20	2.40	0.087	0.095
A1	1.100	1.300	0.043	0.051
B1	0.650	1.050	0.026	0.041
b	0.500	0.900	0.020	0.035
b1	0.400	0.800	0.016	0.32
C	0.400	0.600	0.016	0.024
D	6.700	7.300	0.264	0.287
D1	5.400	5.650	0.213	0.222
E	6.40	6.650	0.252	0.262
e	2.100	2.500	0.083	0.098
F	0.400	0.600	0.016	0.024
L	7.000	8.000	0.276	0.315
L1	1.300	1.700	0.051	0.067
L2	0.700	0.900	0.028	0.035
L3	1.400	1.800	0.055	0.071

STU/D600S

PACKAGE OUTLINE DIMENSIONS

TO-252

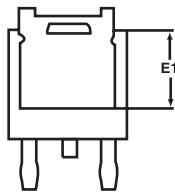
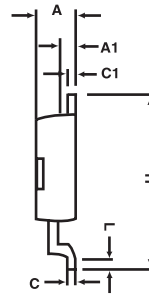
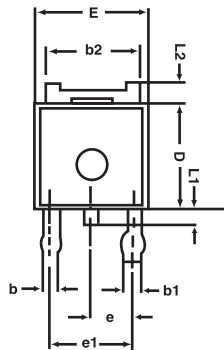

SYMBOLS	MILLIMETERS		INCHES	
	MIN	MAX	MIN	MAX
A	2.25	2.35	0.089	0.093
A1	0.95	1.05	0.037	0.041
b	0.77	0.85	0.030	0.033
b1	0.84	0.94	0.033	0.037
b2	5.30	5.45	0.209	0.215
C	0.49	0.53	0.019	0.021
D	6.00	6.20	0.236	0.244
E	6.40	6.60	0.252	0.260
E1	3.18	3.67	0.125	0.145
e	2.29	BSC	0.090	BSC
H	9.70	10.10	0.382	0.398
L	1.425	1.625	0.056	0.064
L1	0.650	0.850	0.026	0.033
L2	0.600	REF.	0.024	REF.

STU/D600S

TO251 Tube/TO-252 Tape and Reel Data

TO-251 Tube

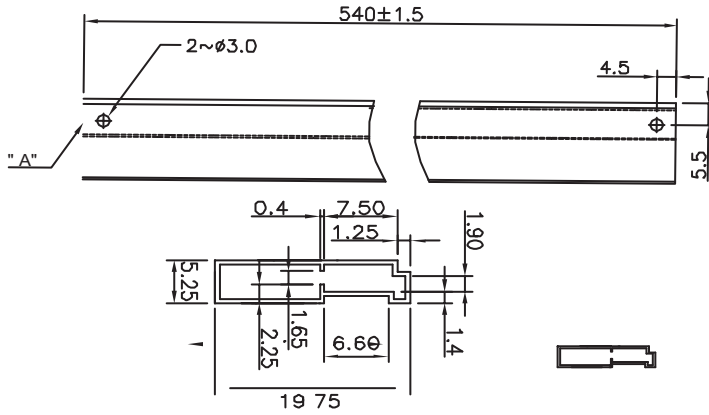

TO-252 Carrier Tape

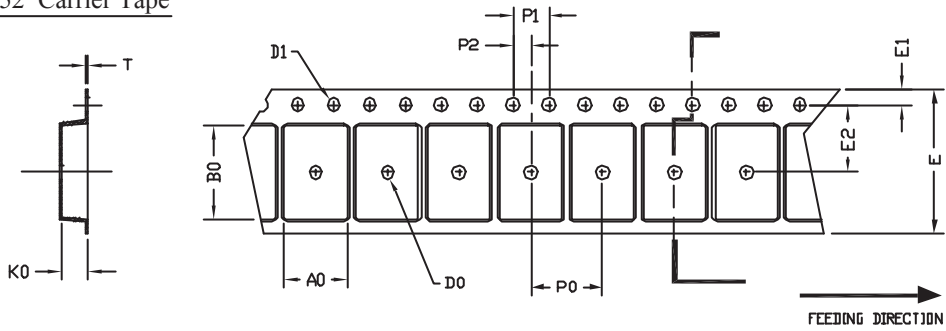

UNIT:mm

PACKAGE	A0	B0	K0	D0	D1	E	E1	E2	P0	P1	P2	T
TO-252 (16 mm)	6.80 ± 0.1	10.3 ± 0.1	2.50 ± 0.1	$\phi 2$	$\phi 1.5$ $+ 0.1$ $- 0$	16.0 $0.3 \pm$	1.75 $0.1 \pm$	7.5 ± 0.15	8.0 ± 0.1	4.0 ± 0.1	2.0 ± 0.15	0.3 ± 0.05

TO-252 Reel

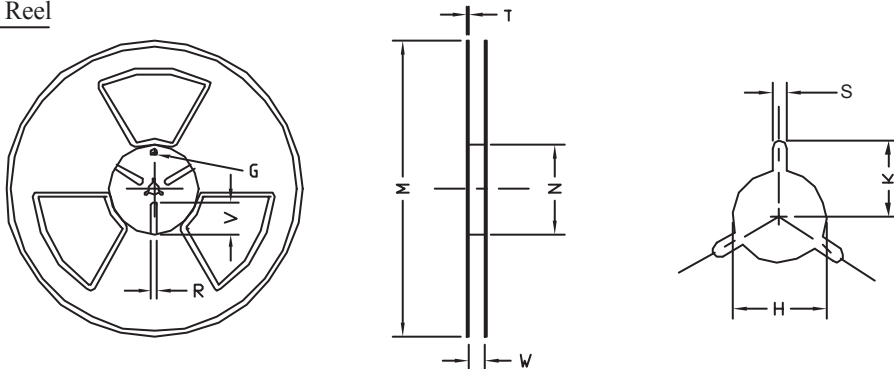

UNIT:mm

TAPE SIZE	REEL SIZE	M	N	W	T	H	K	S	G	R	V
16 mm	$\phi 330$	$\phi 330$ ± 0.5	$\phi 97$ ± 1.0	17.0 $+ 1.5$ $- 0$	2.2	$\phi 13.0$ $+ 0.5$ $- 0.2$	10.6	2.0 ± 0.5	---	---	---