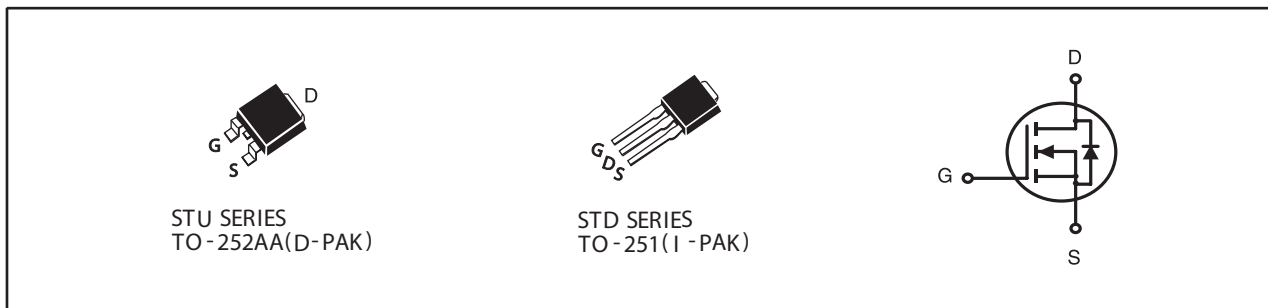

**N-Channel Logic Level Enhancement Mode Field Effect Transistor****PRODUCT SUMMARY**

V <sub>DSS</sub>	I <sub>D</sub>	R <sub>DS(ON)</sub> (mΩ) Max
60V	21A	56 @ V <sub>GS</sub> =10V
		68 @ V <sub>GS</sub> =4.5V

**FEATURES**

- Super high dense cell design for low R<sub>DS(ON)</sub>.
- Rugged and reliable.
- Surface Mount Package.

**ABSOLUTE MAXIMUM RATINGS (T<sub>C</sub>=25°C unless otherwise noted)**

Symbol	Parameter	Limit	Units
V <sub>DS</sub>	Drain-Source Voltage	60	V
V <sub>GS</sub>	Gate-Source Voltage	±20	V
I <sub>D</sub>	Drain Current-Continuous <sup>a</sup>	T <sub>C</sub> =25°C	21
		T <sub>C</sub> =70°C	16.8
I <sub>DM</sub>	-Pulsed <sup>b</sup>	61	A
E <sub>AS</sub>	Single Pulse Avalanche Energy <sup>d</sup>	25	mJ
P <sub>D</sub>	Maximum Power Dissipation	T <sub>C</sub> =25°C	50
		T <sub>C</sub> =70°C	32
T <sub>J</sub> , T <sub>STG</sub>	Operating Junction and Storage Temperature Range	-55 to 150	°C

**THERMAL CHARACTERISTICS**

R <sub>θJC</sub>	Thermal Resistance, Junction-to-Case	2.5	°C/W
R <sub>θJA</sub>	Thermal Resistance, Junction-to-Ambient	50	°C/W

# STU/D606S

Ver 1.2

## ELECTRICAL CHARACTERISTICS (T<sub>C</sub>=25°C unless otherwise noted)

Symbol	Parameter	Conditions	Min	Typ	Max	Units
<b>OFF CHARACTERISTICS</b>						
BV <sub>DSS</sub>	Drain-Source Breakdown Voltage	V <sub>GS</sub> =0V, I <sub>D</sub> =250uA	60			V
I <sub>DSS</sub>	Zero Gate Voltage Drain Current	V <sub>DS</sub> =48V, V <sub>GS</sub> =0V			1	uA
I <sub>GSS</sub>	Gate-Body Leakage Current	V <sub>GS</sub> = ±20V, V <sub>DS</sub> =0V			±100	nA
<b>ON CHARACTERISTICS</b>						
V <sub>GS(th)</sub>	Gate Threshold Voltage	V <sub>DS</sub> =V <sub>GS</sub> , I <sub>D</sub> =250uA	1.0	1.8	3.0	V
R <sub>DS(ON)</sub>	Drain-Source On-State Resistance	V <sub>GS</sub> =10V, I <sub>D</sub> =10.5A		45	56	m ohm
		V <sub>GS</sub> =4.5V, I <sub>D</sub> =9.5A		50	68	m ohm
g <sub>FS</sub>	Forward Transconductance	V <sub>DS</sub> =20V, I <sub>D</sub> =10.5A		16		S
<b>DYNAMIC CHARACTERISTICS <sup>c</sup></b>						
C <sub>ISS</sub>	Input Capacitance	V <sub>DS</sub> =30V, V <sub>GS</sub> =0V f=1.0MHz		825		pF
C <sub>OSS</sub>	Output Capacitance			72		pF
C <sub>RSS</sub>	Reverse Transfer Capacitance			48		pF
<b>SWITCHING CHARACTERISTICS <sup>c</sup></b>						
t <sub>D(ON)</sub>	Turn-On Delay Time	V <sub>DD</sub> =30V I <sub>D</sub> =1A V <sub>GS</sub> =10V R <sub>GEN</sub> =3.3 ohm		13		ns
t <sub>r</sub>	Rise Time			12.5		ns
t <sub>D(OFF)</sub>	Turn-Off Delay Time			38		ns
t <sub>f</sub>	Fall Time			6		ns
Q <sub>g</sub>	Total Gate Charge	V <sub>DS</sub> =30V, I <sub>D</sub> =10.5A, V <sub>GS</sub> =10V		13.5		nC
		V <sub>DS</sub> =30V, I <sub>D</sub> =10.5A, V <sub>GS</sub> =4.5V		6.3		nC
Q <sub>gs</sub>	Gate-Source Charge	V <sub>DS</sub> =30V, I <sub>D</sub> =10.5A, V <sub>GS</sub> =10V		1.6		nC
Q <sub>gd</sub>	Gate-Drain Charge			3.4		nC
<b>DRAIN-SOURCE DIODE CHARACTERISTICS AND MAXIMUM RATINGS</b>						
V <sub>SD</sub>	Diode Forward Voltage	V <sub>GS</sub> =0V, I <sub>S</sub> =1.7A		0.79	1.3	V

### Notes

- Drain current limited by maximum junction temperature.
- Pulse Test: Pulse Width ≤ 300us, Duty Cycle ≤ 2%.
- Guaranteed by design, not subject to production testing.
- Starting T<sub>J</sub>=25°C, L=0.5mH, V<sub>DD</sub> = 30V. (See Figure13)

Dec,03,2012

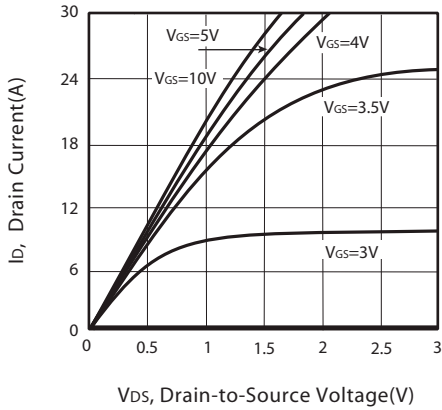

Figure 1. Output Characteristics

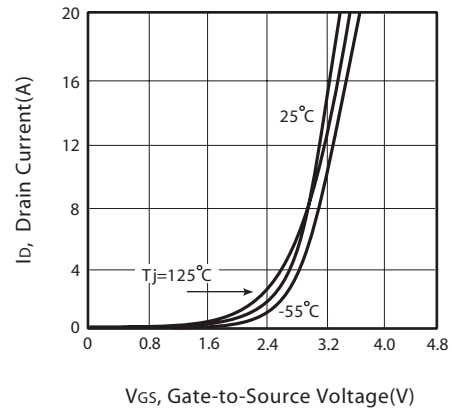

Figure 2. Transfer Characteristics

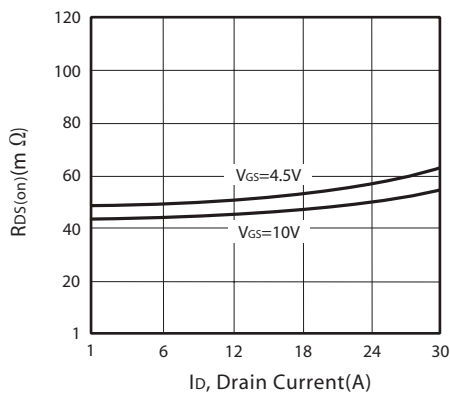

Figure 3. On-Resistance vs. Drain Current and Gate Voltage

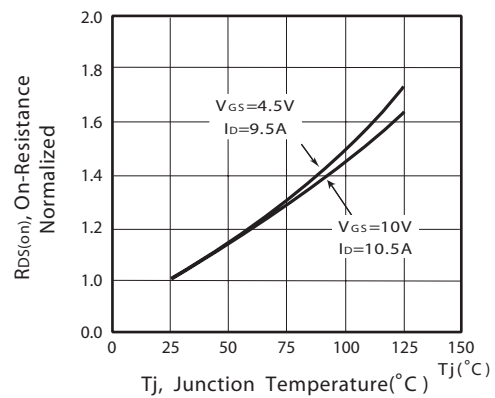

Figure 4. On-Resistance Variation with Drain Current and Temperature

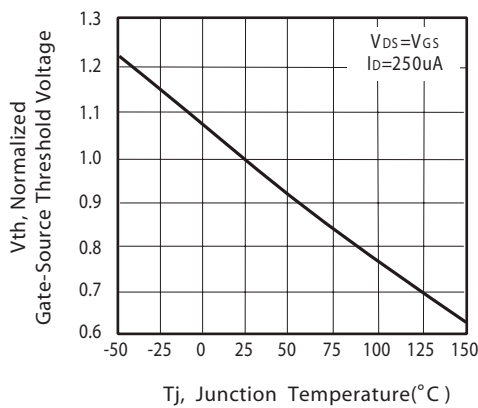

Figure 5. Gate Threshold Variation with Temperature

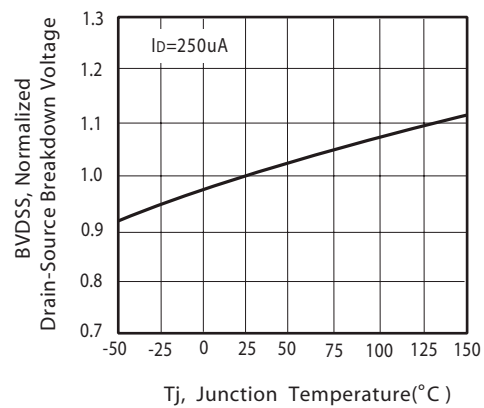

Figure 6. Breakdown Voltage Variation with Temperature

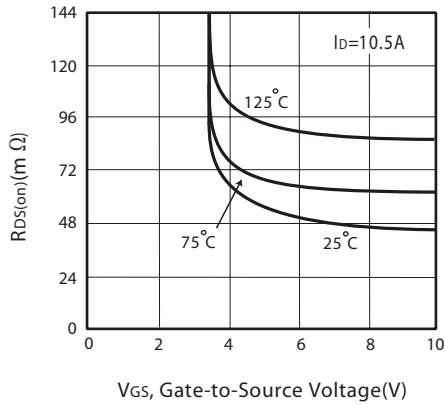

Figure 7. On-Resistance vs. Gate-Source Voltage

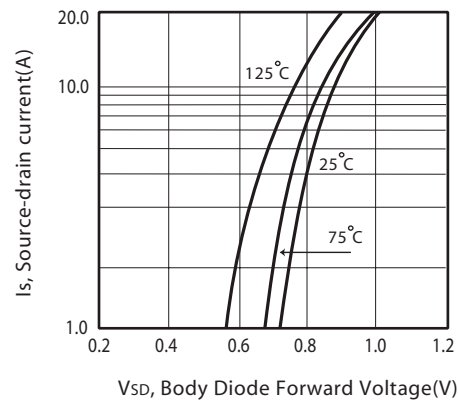

Figure 8. Body Diode Forward Voltage Variation with Source Current

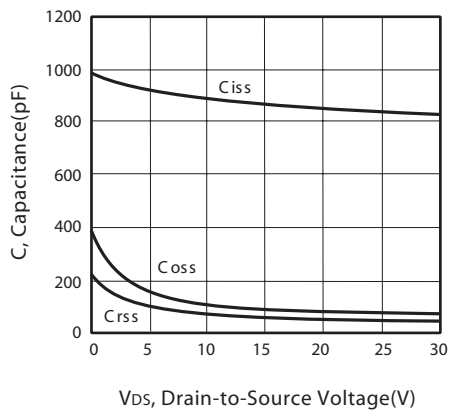

Figure 9. Capacitance

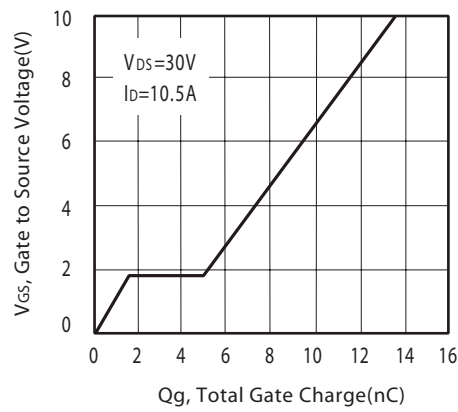

Figure 10. Gate Charge

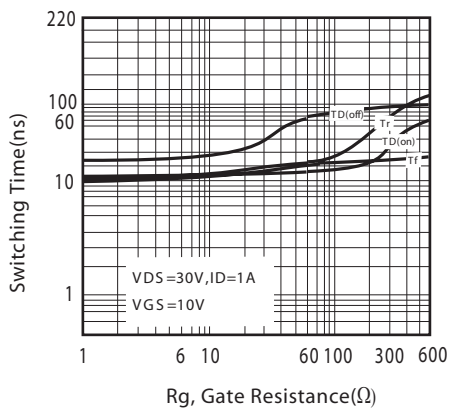

Figure 11. switching characteristics

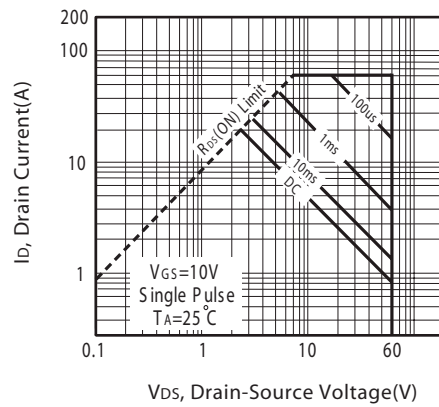
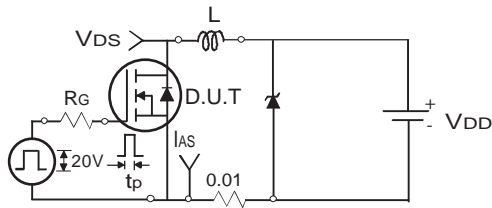
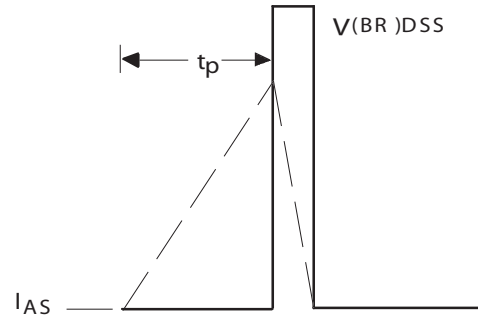

Figure 12. Maximum Safe Operating Area



Uncamped Inductive Test Circuit

Figure 13a.



Unclamped Inductive Waveforms

Figure 13b.

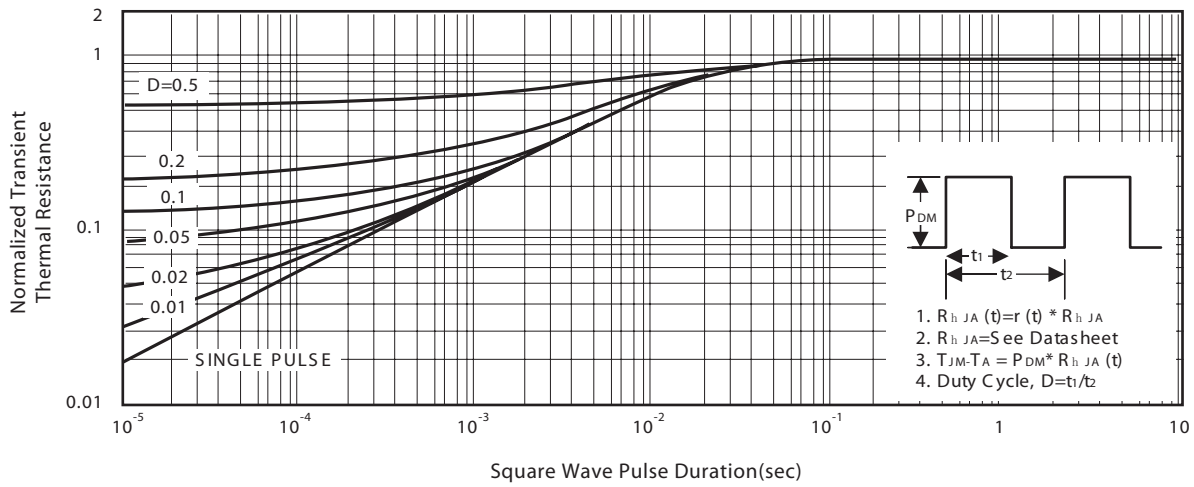
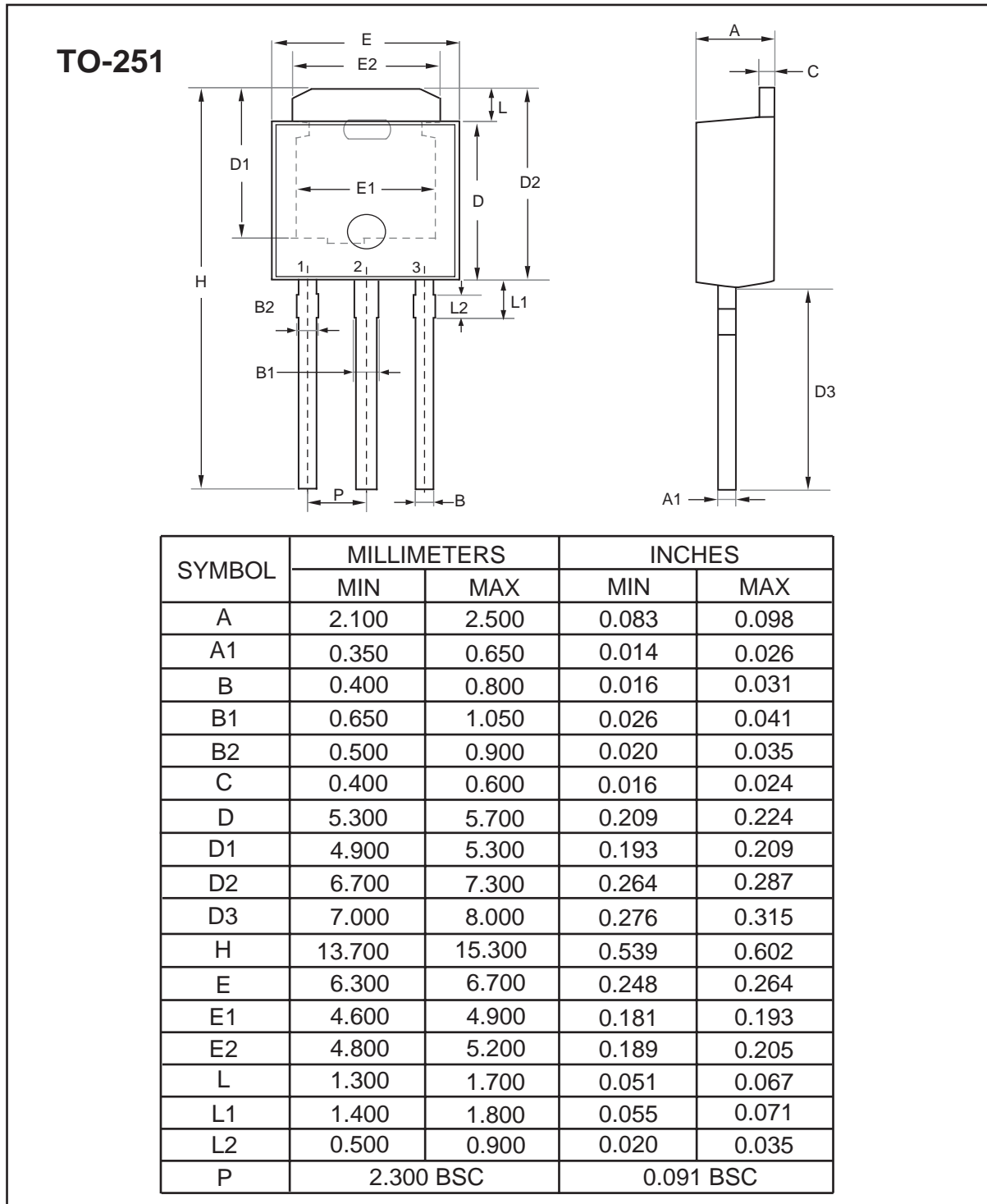
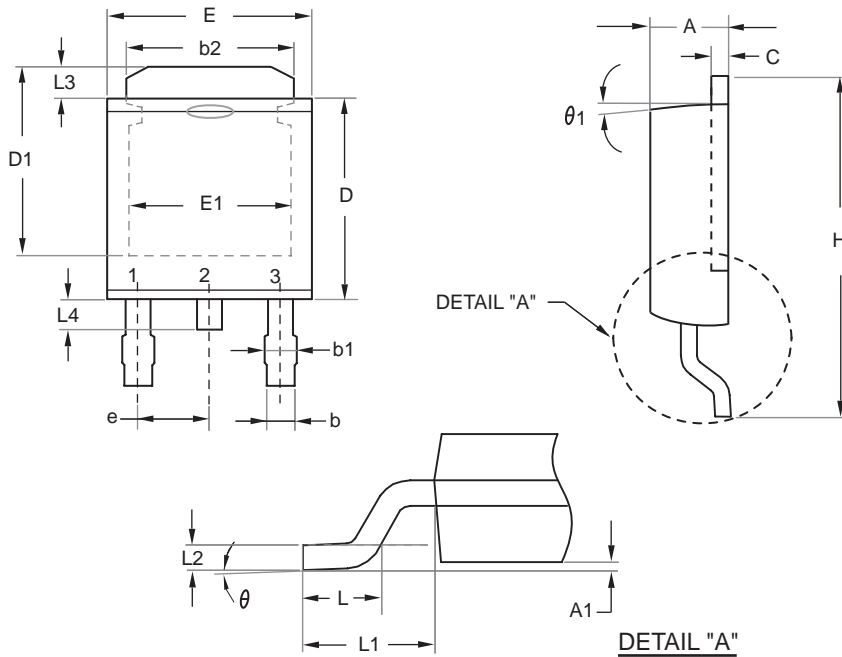

Figure 14. Normalized Thermal Transient Impedance Curve

## PACKAGE OUTLINE DIMENSIONS



TO-252



SYMBOLS	MILLIMETERS		INCHES	
	MIN	MAX	MIN	MAX
A	2.100	2.500	0.083	0.098
A1	0.000	0.200	0.000	0.008
b	0.400	0.889	0.016	0.035
b1	0.770	1.140	0.030	0.045
b2	4.800	5.460	0.189	0.215
C	0.400	0.600	0.016	0.024
D	5.300	6.223	0.209	0.245
D1	4.900	5.515	0.193	0.217
E	6.300	6.731	0.248	0.265
E1	4.400	5.004	0.173	0.197
e	2.290 REF		0.090 BSC	
H	8.900	10.400	0.350	0.409
L	1.397	1.770	0.055	0.070
L1	2.743 REF.		0.108 REF.	
L2	0.508 REF.		0.020 REF.	
L3	0.890	1.700	0.035	0.067
L4	0.500	1.100	0.020	0.043
$\theta$	0°	10°	0°	10°
$\theta_1$	7° REF.		7° REF.	

## TO-251 Tube/TO-252 Tape and Reel Data

### TO-251 Tube

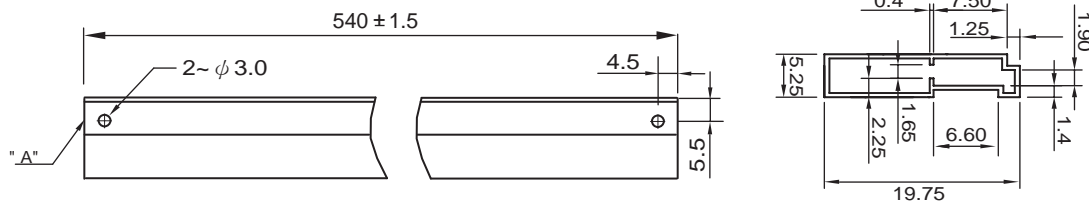

### TO-252 Carrier Tape

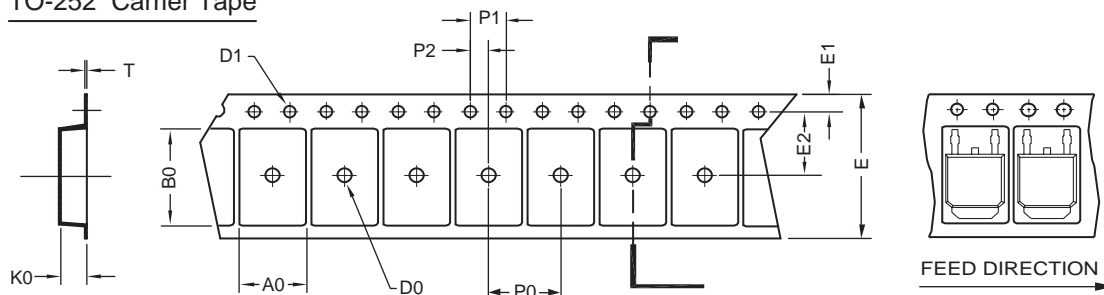

UNIT:mm

PACKAGE	A0	B0	K0	D0	D1	E	E1	E2	P0	P1	P2	T
TO-252 (16 mm)	6.96 ±0.1	10.49 ±0.1	2.79 ±0.1	φ 2	φ 1.5 +0.1 - 0	16.0 ±0.3	1.75 ±0.1	7.5 ±0.15	8.0 ±0.1	4.0 ±0.1	2.0 ±0.15	0.3 ±0.05

### TO-252 Reel

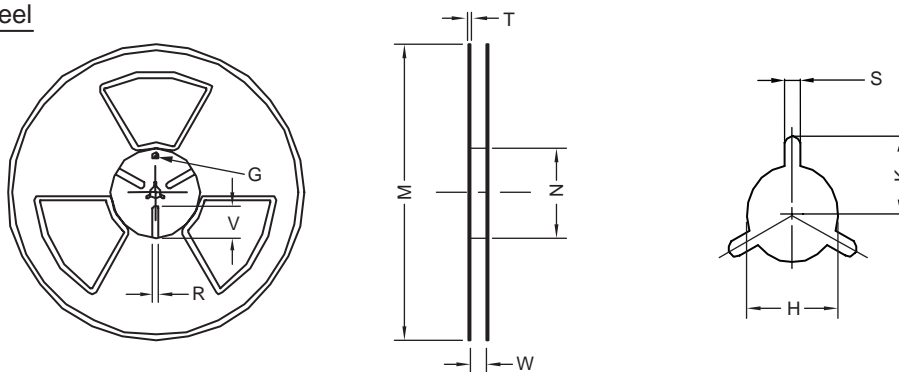

UNIT:mm

TAPE SIZE	REEL SIZE	M	N	W	T	H	K	S	G	R	V
16 mm	φ 330	φ 330 ± 0.5	φ 97 ± 1.0	17.0 + 1.5 - 0	2.2	φ 13.0 + 0.5 - 0.2	10.6	2.0 ±0.5	---	---	---