

## Resonant Mode IGBT®

The Thunderbolt IGBT® used in this Resonant Mode Combi is a new generation of high voltage power IGBTs. Using Non-Punch Through Technology, the Thunderbolt IGBT® offers superior ruggedness and ultrafast switching speed.

### Features

- Low Conduction Loss
- Low Gate Charge
- Ultrafast Tail Current shutoff
- Low forward Diode Voltage ( $V_F$ )
- Ultrasoft Recovery Diode
- SSOA Rated
- RoHS Compliant 

### Typical Applications

- Induction Heating
- Welding
- Medical
- High Power Telecom
- Resonant Mode Phase Shifted Bridge

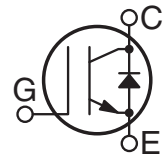
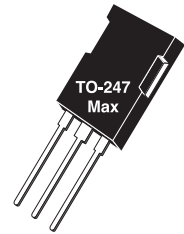

### MAXIMUM RATINGS

 All Ratings:  $T_C = 25^\circ\text{C}$  unless otherwise specified.

Symbol	Parameter	APT50GT120B2RDL(G)	UNIT
$V_{CES}$	Collector-Emitter Voltage	1200	Volts
$V_{GE}$	Gate-Emitter Voltage	$\pm 30$	
$I_{C1}$	Continuous Collector Current <sup>③</sup> @ $T_C = 25^\circ\text{C}$	106	Amps
$I_{C2}$	Continuous Collector Current @ $T_C = 110^\circ\text{C}$	50	
$I_{CM}$	Pulsed Collector Current <sup>①</sup> @ $T_C = 150^\circ\text{C}$	150	
SSOA	Switching Safe Operating Area @ $T_J = 150^\circ\text{C}$	150A @ 1200V	
$P_D$	Total Power Dissipation	694	Watts
$T_J, T_{STG}$	Operating and Storage Junction Temperature Range	-55 to 150	$^\circ\text{C}$
$T_L$	Max. Lead Temp. for Soldering: 0.063" from Case for 10 Sec.	300	

### STATIC ELECTRICAL CHARACTERISTICS

Symbol	Characteristic / Test Conditions	MIN	TYP	MAX	Units
$V_{(BR)CES}$	Collector-Emitter Breakdown Voltage ( $V_{GE} = 0V, I_C = 3mA$ )	1200			Volts
$V_{GE(TH)}$	Gate Threshold Voltage ( $V_{CE} = V_{GE}, I_C = 2mA, T_J = 25^\circ\text{C}$ )	4.5	5.5	6.5	
$V_{CE(ON)}$	Collector-Emitter On Voltage ( $V_{GE} = 15V, I_C = 50A, T_J = 25^\circ\text{C}$ )	2.7	3.2	3.7	
	Collector-Emitter On Voltage ( $V_{GE} = 15V, I_C = 50A, T_J = 125^\circ\text{C}$ )		4.0		
$I_{CES}$	Collector Cut-off Current ( $V_{CE} = 1200V, V_{GE} = 0V, T_J = 25^\circ\text{C}$ ) <sup>②</sup>			300	$\mu\text{A}$
	Collector Cut-off Current ( $V_{CE} = 1200V, V_{GE} = 0V, T_J = 125^\circ\text{C}$ ) <sup>②</sup>			1500	
$I_{GES}$	Gate-Emitter Leakage Current ( $V_{GE} = \pm 20V$ )			300	nA
$R_{G(int)}$	Integrated Gate Resistor		5		$\Omega$

 **CAUTION:** These Devices are Sensitive to Electrostatic Discharge. Proper Handling Procedures Should Be Followed.

## DYNAMIC CHARACTERISTICS

APT50GT120B2RDL(G)

Symbol	Characteristic	Test Conditions	MIN	TYP	MAX	UNIT	
$C_{ies}$	Input Capacitance	<b>Capacitance</b> $V_{GE} = 0V, V_{CE} = 25V$ $f = 1 \text{ MHz}$		2500		pF	
$C_{oes}$	Output Capacitance			250			
$C_{res}$	Reverse Transfer Capacitance			155			
$V_{GEP}$	Gate-to-Emitter Plateau Voltage	Gate Charge		7.5		V	
$Q_g$	Total Gate Charge <sup>③</sup>	$V_{GE} = 15V$		240		nC	
$Q_{ge}$	Gate-Emitter Charge	$V_{CE} = 600V$		20			
$Q_{gc}$	Gate-Collector ("Miller") Charge	$I_C = 50A$		110			
SSOA	Switching Safe Operating Area	$T_J = 150^\circ\text{C}, R_G = 1.0\Omega^{\text{⑦}}, V_{GE} = 15V, L = 100\mu\text{H}, V_{CE} = 1200V$	150			A	
$t_{d(on)}$	Turn-on Delay Time	<b>Inductive Switching (25°C)</b> $V_{CC} = 800V$ $V_{GE} = 15V$ $I_C = 50A$ $R_G = 4.7\Omega^{\text{⑦}}$ $T_J = +25^\circ\text{C}$		23		ns	
$t_r$	Current Rise Time			50			
$t_{d(off)}$	Turn-off Delay Time			215			
$t_f$	Current Fall Time			26			
$E_{on1}$	Turn-on Switching Energy <sup>④</sup>				3585		μJ
$E_{on2}$	Turn-on Switching Energy (Diode) <sup>⑤</sup>			4835			
$E_{off}$	Turn-off Switching Energy <sup>⑥</sup>			1910			
$t_{d(on)}$	Turn-on Delay Time	<b>Inductive Switching (125°C)</b> $V_{CC} = 800V$ $V_{GE} = 15V$ $I_C = 50A$ $R_G = 4.7\Omega^{\text{⑦}}$ $T_J = +125^\circ\text{C}$		23		ns	
$t_r$	Current Rise Time			50			
$t_{d(off)}$	Turn-off Delay Time			255			
$t_f$	Current Fall Time			50			
$E_{on1}$	Turn-on Switching Energy <sup>④</sup>				3580		μJ
$E_{on2}$	Turn-on Switching Energy (Diode) <sup>⑤</sup>				6970		
$E_{off}$	Turn-off Switching Energy <sup>⑥</sup>			2750			

## THERMAL AND MECHANICAL CHARACTERISTICS

Symbol	Characteristic	MIN	TYP	MAX	UNIT
$R_{\theta JC}$	Junction to Case ( <b>IGBT</b> )			.18	°C/W
$R_{\theta JC}$	Junction to Case ( <b>DIODE</b> )			.61	
$W_T$	Package Weight		5.9		gm

① Repetitive Rating: Pulse width limited by maximum junction temperature.

② For Combi devices,  $I_{ces}$  includes both IGBT and FRED leakages

③ See MIL-STD-750 Method 3471.

④  $E_{on1}$  is the clamped inductive turn-on energy of the IGBT only, without the effect of a commutating diode reverse recovery current adding to the IGBT turn-on loss. Tested in inductive switching test circuit shown in figure 21, but with a Silicon Carbide diode.

⑤  $E_{on2}$  is the clamped inductive turn-on energy that includes a commutating diode reverse recovery current in the IGBT turn-on switching loss. (See Figures 21, 22.)

⑥  $E_{off}$  is the clamped inductive turn-off energy measured in accordance with JEDEC standard JESD24-1. (See Figures 21, 23.)

⑦  $R_G$  is external gate resistance, not including  $R_{G(int)}$  nor gate driver impedance.

⑧ Continuous current limited by package lead temperature.

Microsemi reserves the right to change, without notice, the specifications and information contained herein.

**TYPICAL PERFORMANCE CURVES**

**APT50GT120B2RDL(G)**

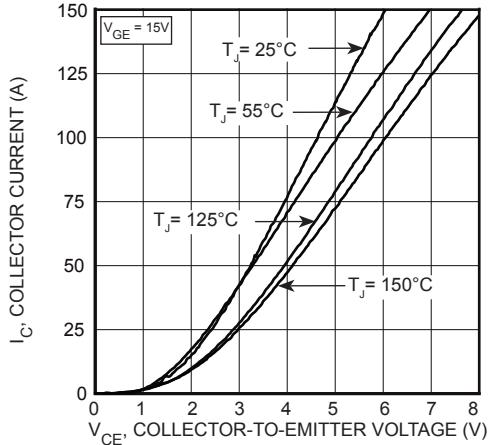

**FIGURE 1, Output Characteristics ( $T_j = 25^\circ C$ )**

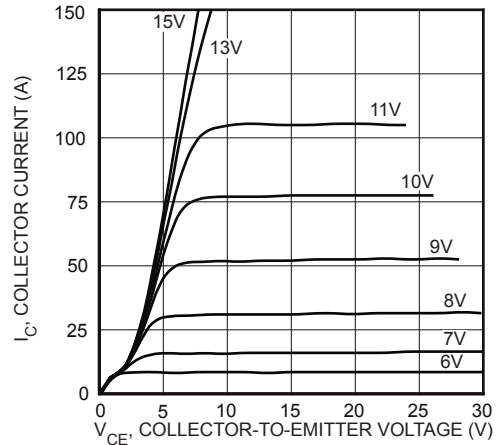

**FIGURE 2, Output Characteristics ( $T_j = 25^\circ C$ )**

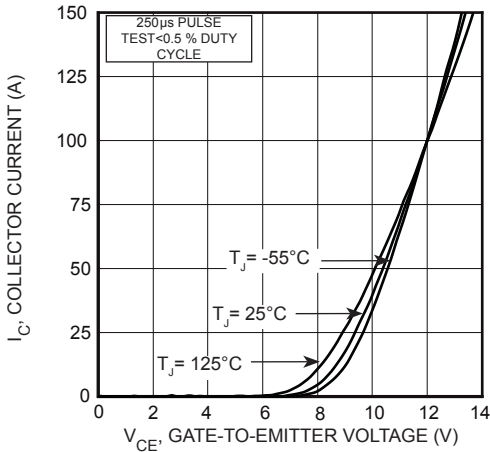

**FIGURE 3, Transfer Characteristics**

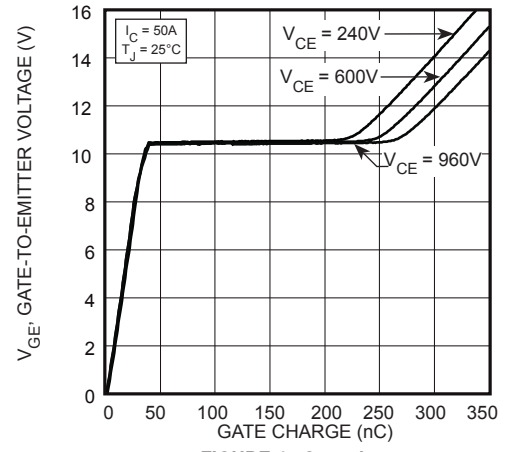

**FIGURE 4, Gate charge**

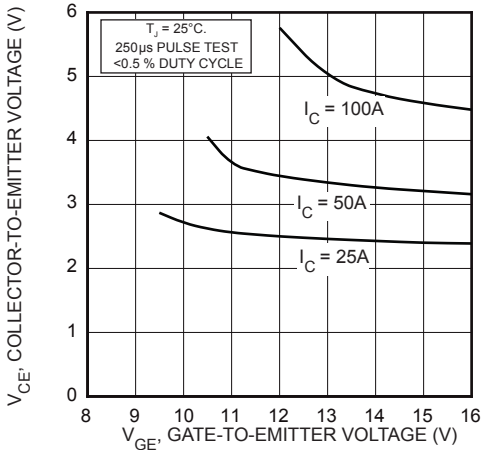

**FIGURE 5, On State Voltage vs Gate-to-Emitter Voltage**

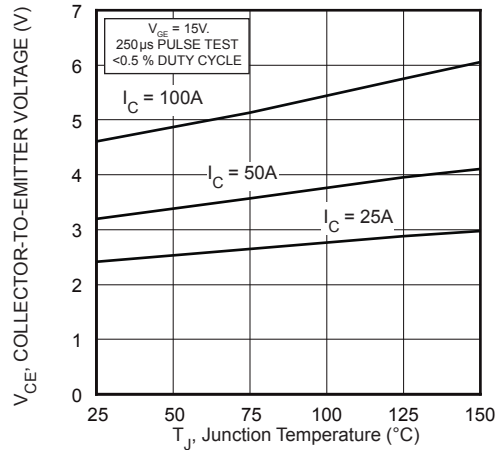

**FIGURE 6, On State Voltage vs Junction Temperature**

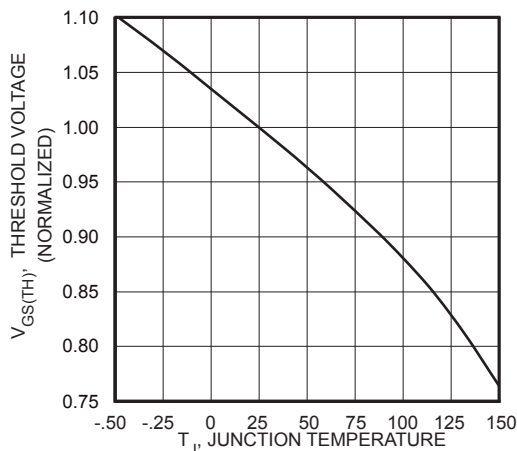

**FIGURE 7, Threshold Voltage vs Junction Temperature**

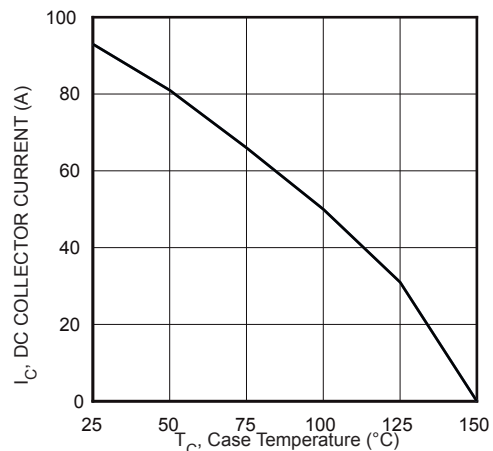

**FIGURE 8, DC Collector Current vs Case Temperature**

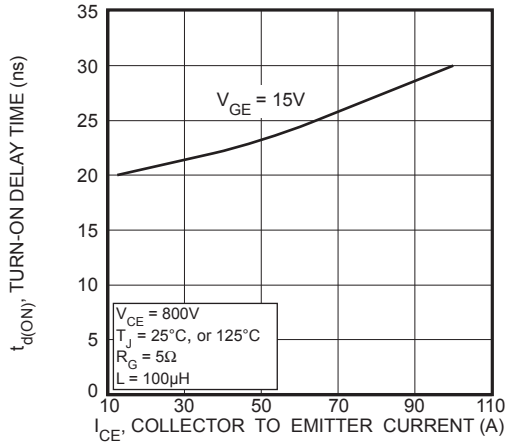

FIGURE 9, Turn-On Delay Time vs Collector Current

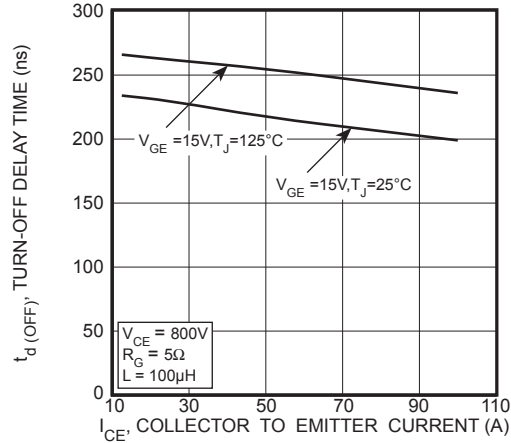

FIGURE 10, Turn-Off Delay Time vs Collector Current

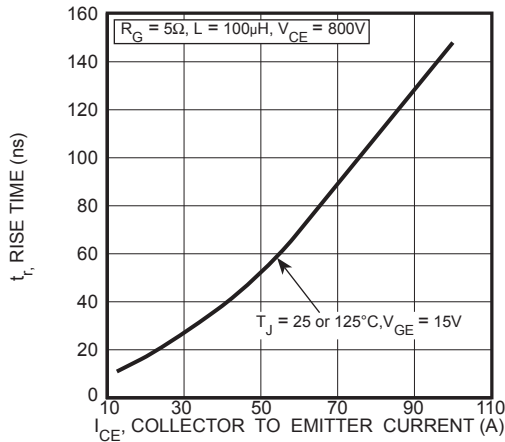

FIGURE 11, Current Rise Time vs Collector Current

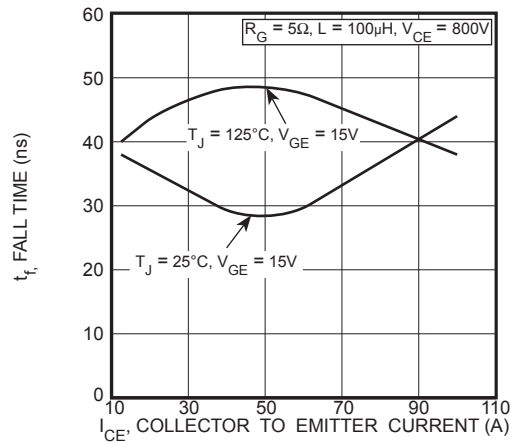

FIGURE 12, Current Fall Time vs Collector Current

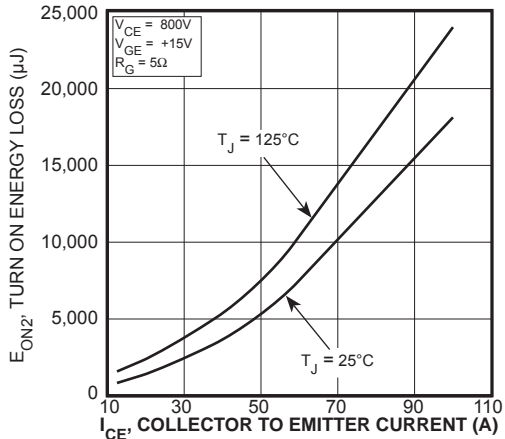

FIGURE 13, Turn-On Energy Loss vs Collector Current

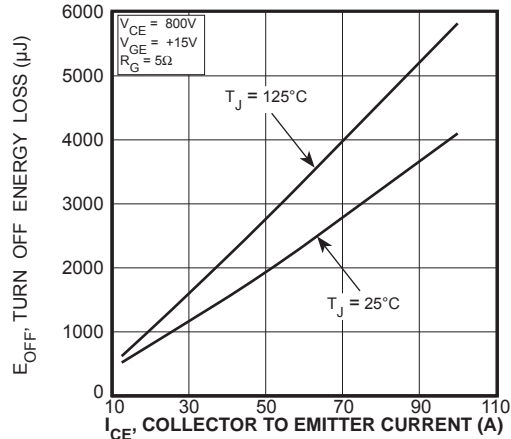

FIGURE 14, Turn Off Energy Loss vs Collector Current

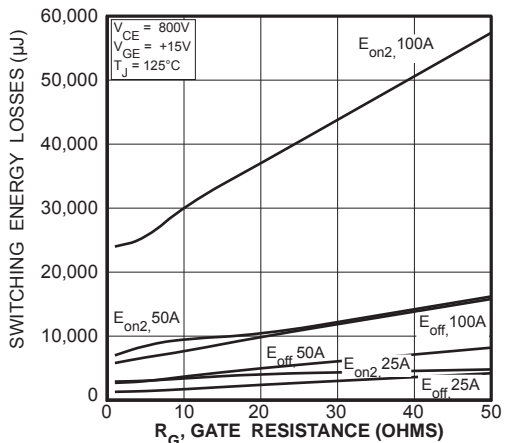

FIGURE 15, Switching Energy Losses vs. Gate Resistance

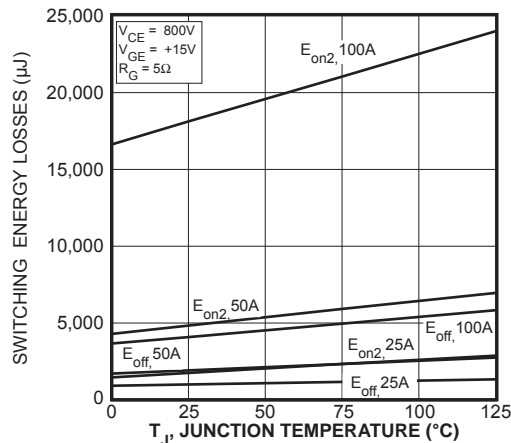

FIGURE 16, Switching Energy Losses vs Junction Temperature

**TYPICAL PERFORMANCE CURVES**

**APT50GT120B2RDL(G)**

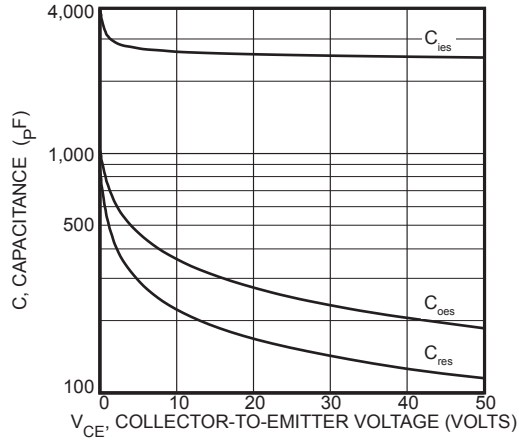

Figure 17, Capacitance vs Collector-To-Emitter Voltage

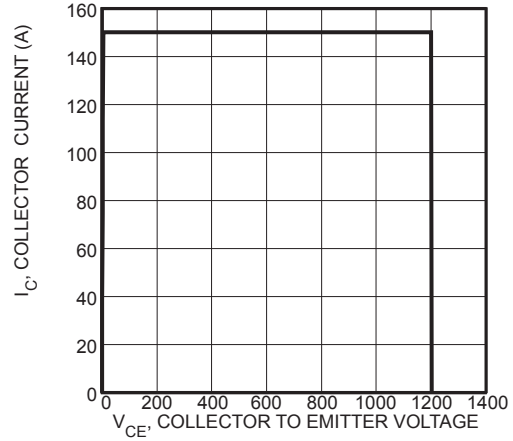

Figure 18, Minimum Switching Safe Operating Area

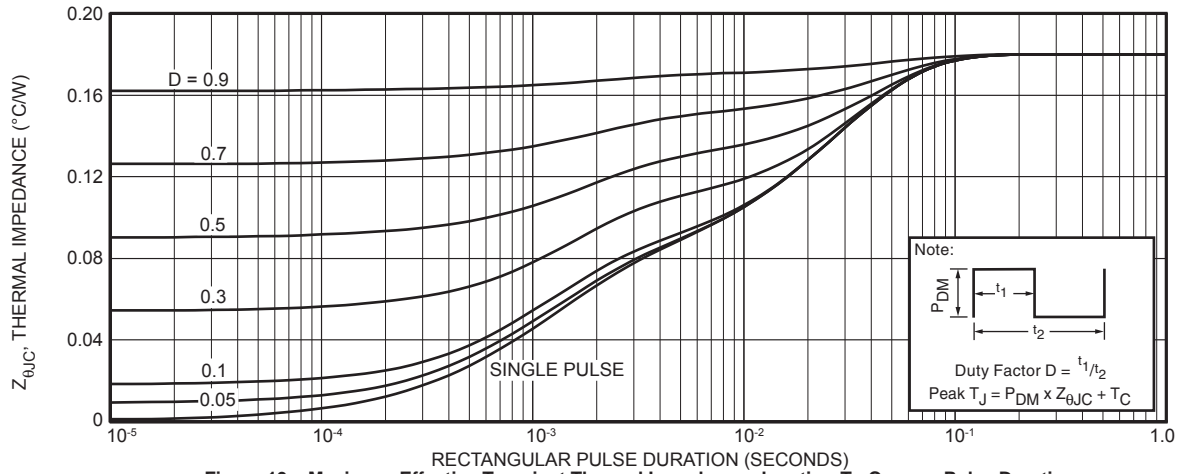

Figure 19a, Maximum Effective Transient Thermal Impedance, Junction-To-Case vs Pulse Duration

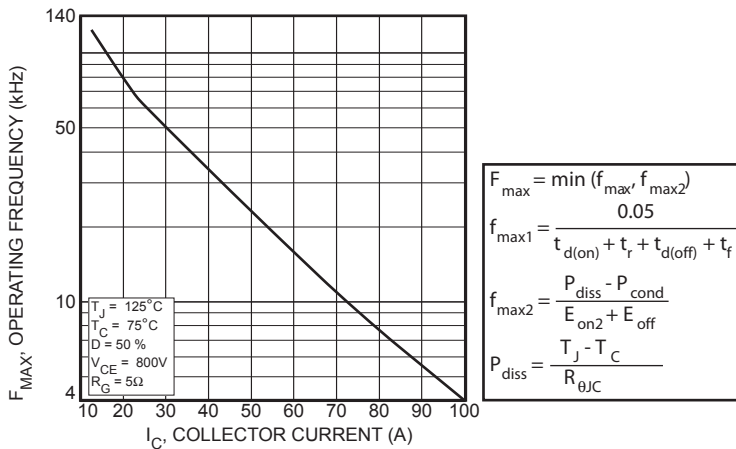

Figure 20, Operating Frequency vs Collector Current

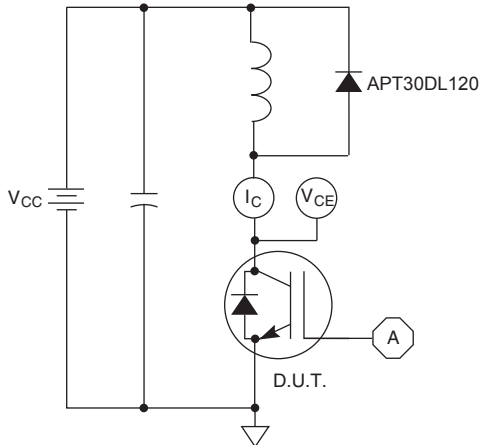

Figure 21, Inductive Switching Test Circuit

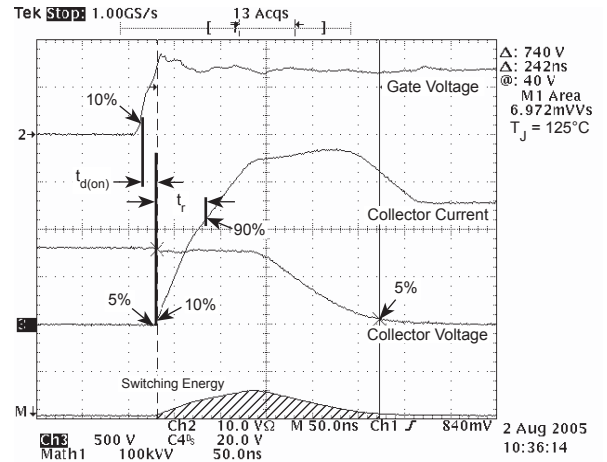

Figure 22, Turn-on Switching Waveforms and Definitions

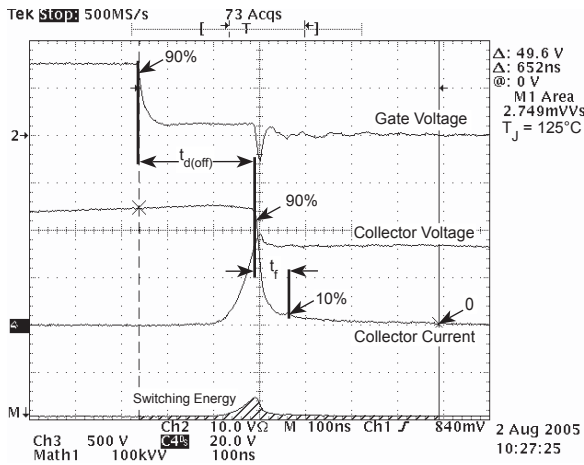

Figure 23, Turn-off Switching Waveforms and Definitions

# ULTRAFAST SOFT RECOVERY ANTI-PARALLEL DIODE

**MAXIMUM RATINGS**

All Ratings:  $T_C = 25^\circ\text{C}$  unless otherwise specified.

Symbol	Characteristic / Test Conditions	APT50GT120B2RDL(G)		UNIT
$I_F(\text{AV})$	Maximum Average Forward Current ( $T_C = 145^\circ\text{C}$ , Duty Cycle = 0.5)		30	Amps
$I_F(\text{RMS})$	RMS Forward Current (Square wave, 50% duty)		81	
$I_{\text{FSM}}$	Non-Repetitive Forward Surge Current ( $T_J = 45^\circ\text{C}$ , 8.3ms)		60	

**STATIC ELECTRICAL CHARACTERISTICS**

Symbol	Characteristic / Test Conditions	MIN	TYP	MAX	UNIT
$V_F$	Forward Voltage		$I_F = 30\text{A}$	1.6	Volts
			$I_F = 60\text{A}$	2.0	
			$I_F = 30\text{A}, T_J = 125^\circ\text{C}$	1.6	

**DYNAMIC CHARACTERISTICS**

Symbol	Characteristic	Test Conditions	MIN	TYP	MAX	UNIT
$t_{\text{rr}}$	Reverse Recovery Time	$I_F = 1\text{A}, di_F/dt = -100\text{A}/\mu\text{s}, V_R = 30\text{V}, T_J = 25^\circ\text{C}$	-	61		ns
$t_{\text{rr}}$	Reverse Recovery Time	$I_F = 30\text{A}, di_F/dt = -200\text{A}/\mu\text{s}, V_R = 800\text{V}, T_C = 25^\circ\text{C}$	-	592		
$Q_{\text{rr}}$	Reverse Recovery Charge		-	2694		nC
$I_{\text{RRM}}$	Maximum Reverse Recovery Current		-	9	-	Amps
$t_{\text{rr}}$	Reverse Recovery Time	$I_F = 30\text{A}, di_F/dt = -200\text{A}/\mu\text{s}, V_R = 800\text{V}, T_C = 125^\circ\text{C}$	-	389		ns
$Q_{\text{rr}}$	Reverse Recovery Charge		-	3459		nC
$I_{\text{RRM}}$	Maximum Reverse Recovery Current		-	15	-	Amps
$t_{\text{rr}}$	Reverse Recovery Time	$I_F = 30\text{A}, di_F/dt = -1000\text{A}/\mu\text{s}, V_R = 800\text{V}, T_C = 125^\circ\text{C}$	-	165		ns
$Q_{\text{rr}}$	Reverse Recovery Charge		-	4646		nC
$I_{\text{RRM}}$	Maximum Reverse Recovery Current		-	44		Amps

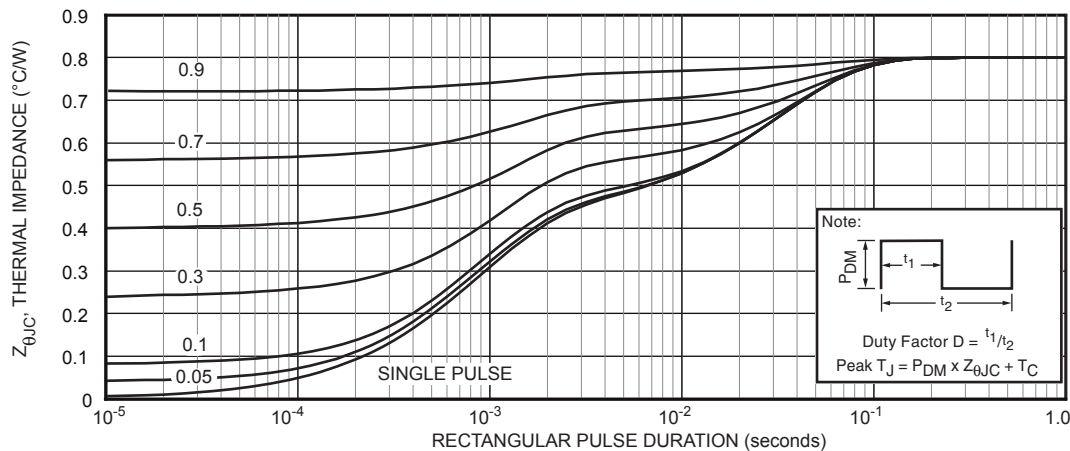

FIGURE 24a. MAXIMUM EFFECTIVE TRANSIENT THERMAL IMPEDANCE, JUNCTION-TO-CASE vs. PULSE DURATION

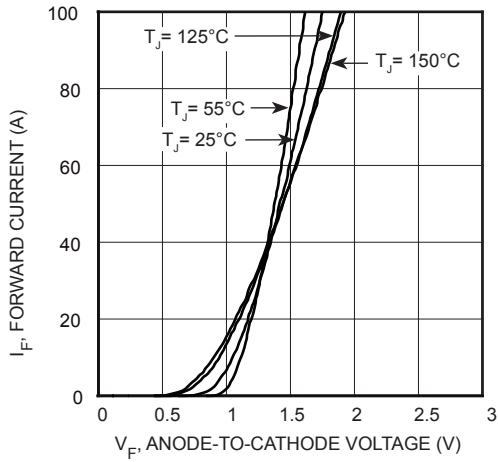

FIGURE 2, Forward Current vs. Forward Voltage

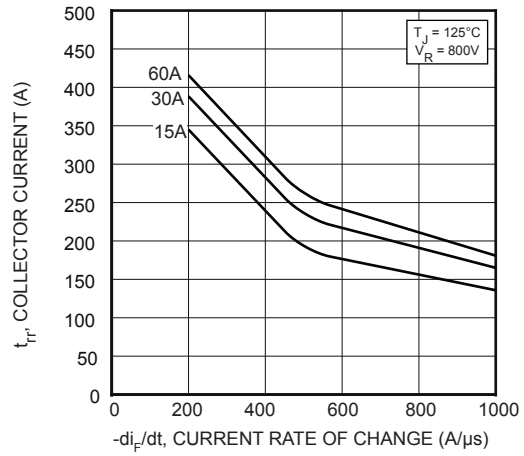

FIGURE 3, Reverse Recovery Time vs. Current Rate of Change

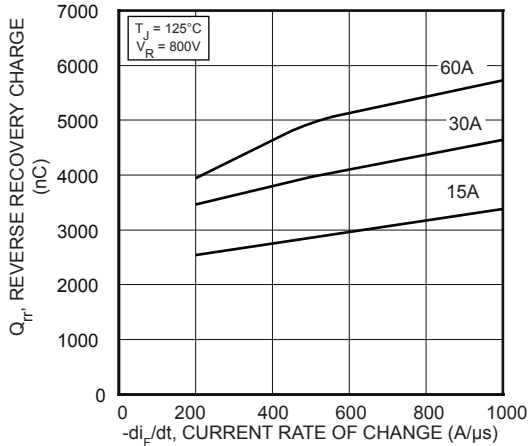

FIGURE 4, Reverse Recovery Charge vs. Current Rate of Change

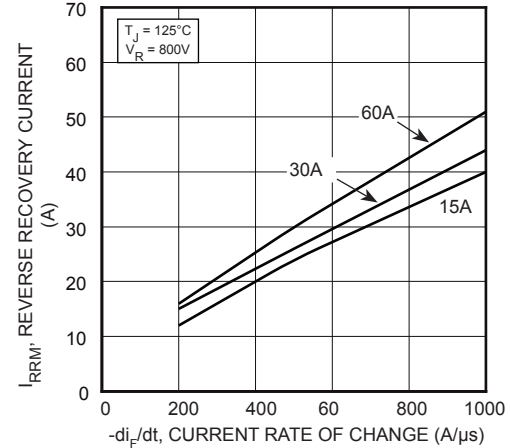

FIGURE 5, Reverse Recovery Current vs. Current Rate of Change

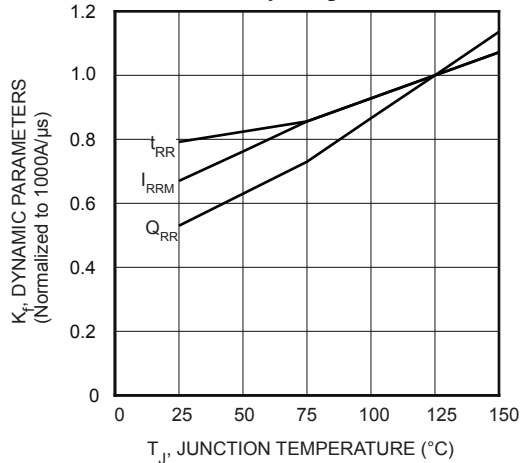

FIGURE 6, Dynamic Parameters vs. Junction Temperature

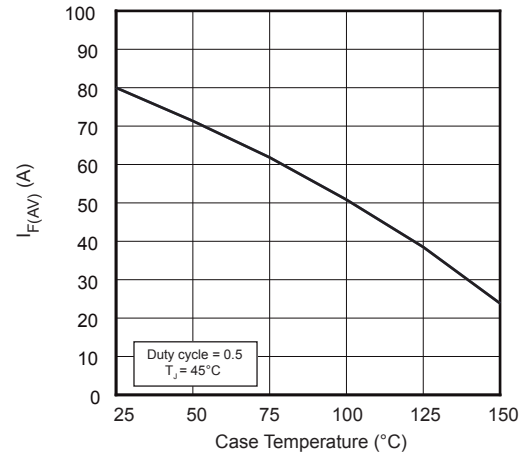

FIGURE 7, Maximum Average Forward Current vs. Case Temperature

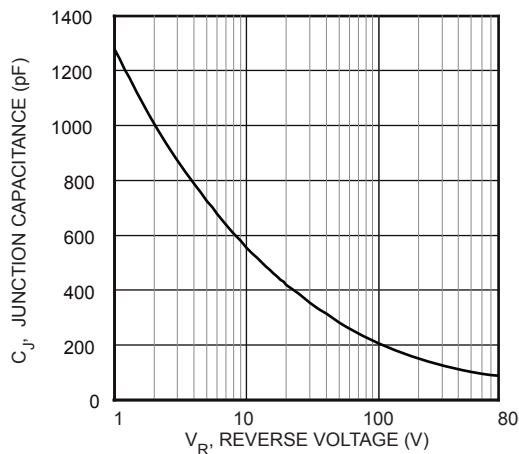

FIGURE 8, Junction Capacitance vs. Reverse Voltage



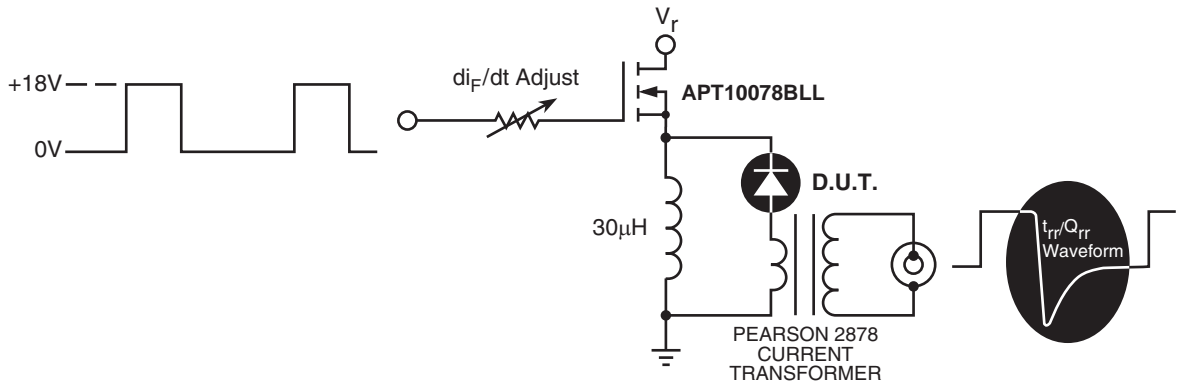

Figure 32. Diode Test Circuit

- 1  $I_F$  - Forward Conduction Current
- 2  $di_F/dt$  - Rate of Diode Current Change Through Zero Crossing.
- 3  $I_{RRM}$  - Maximum Reverse Recovery Current.
- 4  $t_{rr}$  - Reverse Recovery Time, measured from zero crossing where diode current goes from positive to negative, to the point at which the straight line through  $I_{RRM}$  and  $0.25 \cdot I_{RRM}$  passes through zero.
- 5  $Q_{rr}$  - Area Under the Curve Defined by  $I_{RRM}$  and  $t_{rr}$ .

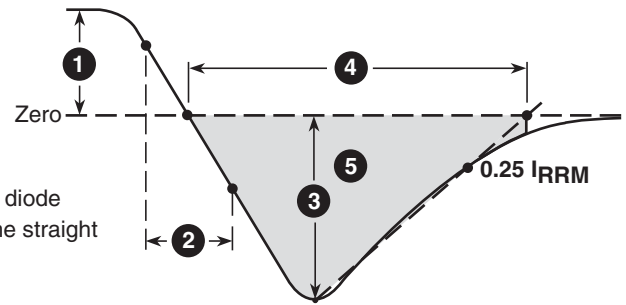
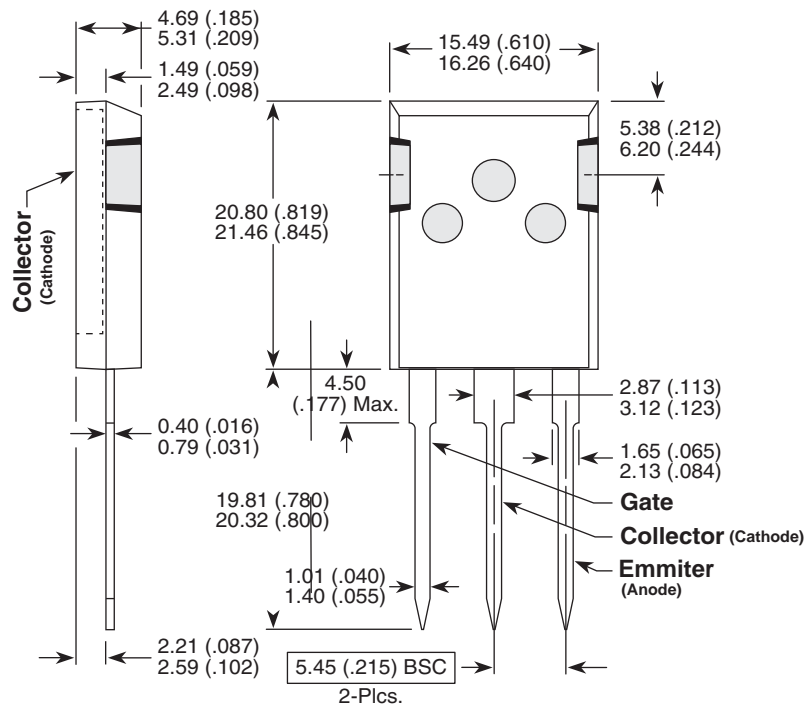

Figure 33. Diode Reverse Recovery Waveform and Definitions

**T-MAX® (B2) Package Outline**

e1 SAC: Tin, Silver, Copper



Dimensions in Millimeters and (Inches)

Microsemi's products are covered by one or more of U.S. patents 4,895,810 5,045,903 5,089,434 5,182,234 5,019,522 5,262,336 6,503,786 5,256,583 4,748,103 5,283,202 5,231,474 5,434,095 5,528,058 6,939,743, 7,352,045 5,283,201 5,801,417 5,648,283 7,196,634 6,664,594 7,157,886 6,939,743 7,342,262 and foreign patents. US and Foreign patents pending. All Rights Reserved.