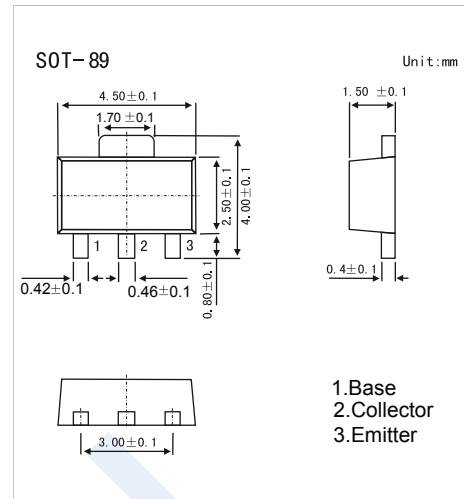


NPN Transistors

KXC1504

■ Features

- Collector Power Dissipation: $P_c=0.5W$
- Collector Current: $I_c=1.5A$

■ Absolute Maximum Ratings $T_a = 25^\circ C$

Parameter	Symbol	Rating	Unit
Collector-base voltage	V_{CB0}	40	V
Collector-emitter voltage	V_{CE0}	25	V
Emitter-base voltage	V_{EB0}	5	V
Collector current	I_c	1.5	A
Collector power dissipation	P_c	0.5	W
Junction temperature	T_j	150	$^\circ C$
Storage temperature	T_{stg}	-55 to +150	$^\circ C$

■ Electrical Characteristics $T_a = 25^\circ C$

Parameter	Symbol	Testconditions	Min	Typ	Max	Unit
Collector-base breakdown voltage	V_{CB0}	$I_c = 100 \mu A, I_E = 0$	40			V
Collector-emitter breakdown voltage	V_{CE0}	$I_c = 0.1mA, I_B = 0$	25			V
Emitter-base breakdown voltage	V_{EB0}	$I_E = 100 \mu A, I_c = 0$	5			V
Collector cut-off current	I_{CBO}	$V_{CB} = 40V, I_E = 0$			0.1	μA
Collector cut-off current	I_{CEO}	$V_{CE} = 20V, I_B = 0$			0.1	μA
Emitter cut-off current	I_{EBO}	$V_{EB} = 5V, I_c = 0$			0.1	μA
DC current gain	h_{FE}	$V_{CE} = 1V, I_c = 100mA$	160		320	
		$V_{CE} = 1V, I_c = 800mA$	40			
Collector-emitter saturation voltage	$V_{CE(sat)}$	$I_c = 800mA, I_B = 80mA$			0.5	V
Base-emitter saturation voltage	$V_{BE(sat)}$	$I_c = 800mA, I_B = 80mA$			1.2	V
Base-emitter on voltage	$V_{BE(on)}$	$I_c = 1V, V_{CE} = 10mA$			1	V
Base-emitter positive favor voltage	V_{BEF}	$I_B = 1A$			1.3	V
output capacitance	C_{ob}	$V_{CB} = 10V, I_E = 0, f = 1MHz$			15	pF
Transition frequency	f_T	$V_{CE} = 10V, I_c = 50mA$	100			MHz

■ Marking

Marking	MY
---------	----

NPN Transistors

KXC1504

■ Typical Characteristics

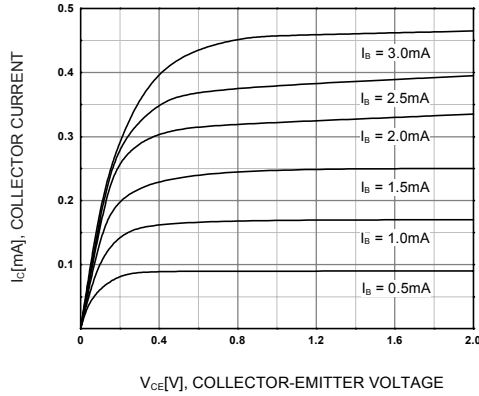


Figure 1. Static Characteristic

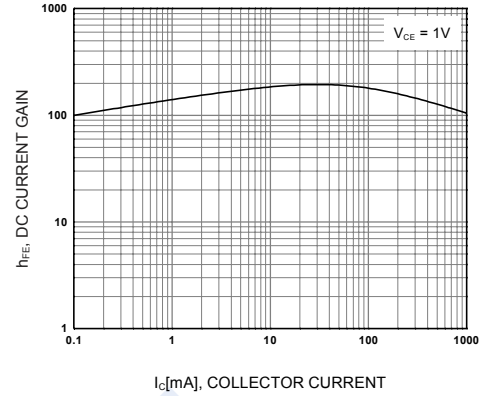


Figure 2. DC current Gain

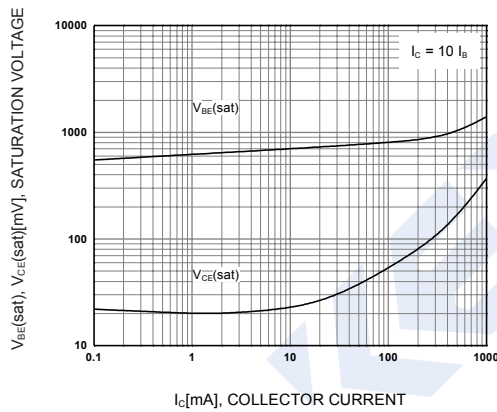
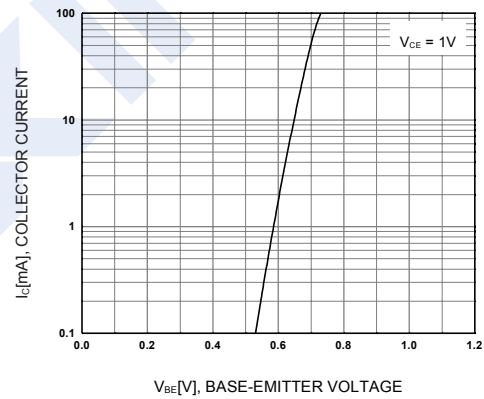
Figure 3. Base-Emitter Saturation Voltage
Collector-Emitter Saturation Voltage

Figure 4. Base-Emitter On Voltage

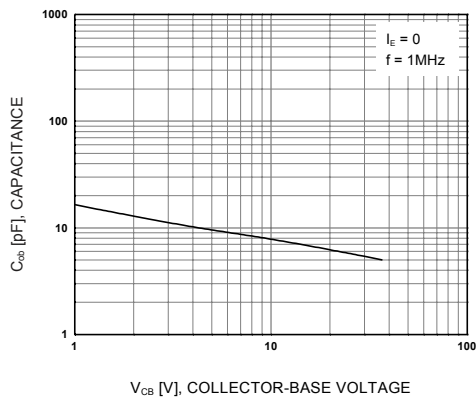


Figure 5. Collector Output Capacitance

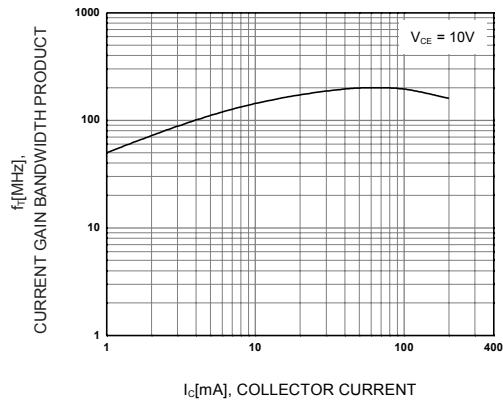


Figure 6. Current Gain Bandwidth Product