

SWITCHING APPLICATION.  
INTERFACE CIRCUIT AND DRIVER CIRCUIT APPLICATION.

### FEATURES

- With Built-in Bias Resistors.
- Simplify Circuit Design.
- Reduce a Quantity of Parts and Manufacturing Process.

### EQUIVALENT CIRCUIT

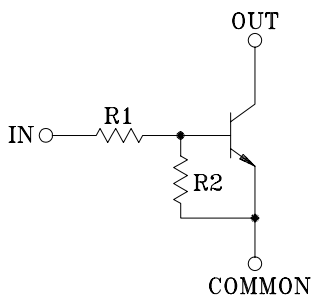

### BIAS RESISTOR VALUES

TYPE NO.	R1(kΩ)	R2(kΩ)
KRC101M	4.7	4.7
KRC102M	10	10
KRC103M	22	22
KRC104M	47	47
KRC105M	2.2	47
KRC106M	4.7	47

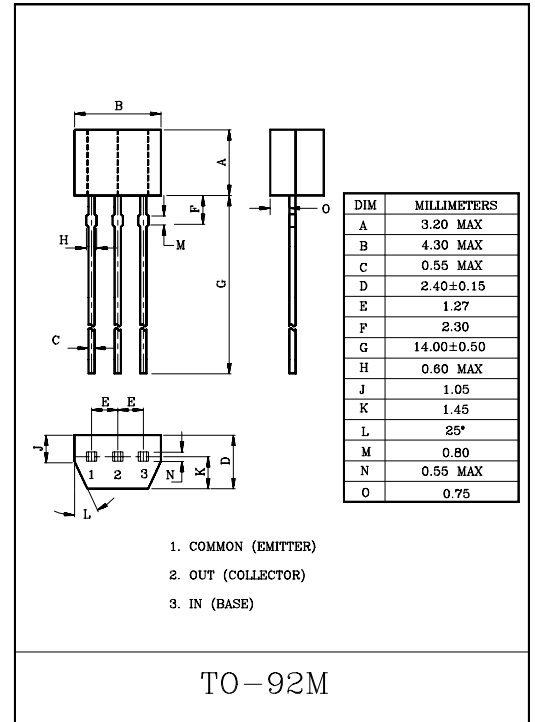

### MAXIMUM RATINGS (Ta=25°C)

CHARACTERISTIC		SYMBOL	RATING	UNIT
Output Voltage	KRC101M ~106M	V <sub>O</sub>	50	V
Input Voltage	KRC101M	V <sub>I</sub>	20, -10	V
	KRC102M		30, -10	
	KRC103M		40, -10	
	KRC104M		40, -10	
	KRC105M		12, -5	
	KRC106M		20, -5	
Output Current	KRC101M ~106M	I <sub>O</sub>	100	mA
Power Dissipation		P <sub>D</sub>	400	mW
Junction Temperature		T <sub>j</sub>	150	°C
Storage Temperature Range		T <sub>stg</sub>	-55~150	°C

# KRC101M~KRC106M

## ELECTRICAL CHARACTERISTICS (Ta=25°C)

CHARACTERISTIC		SYMBOL	TEST CONDITION	MIN.	TYP.	MAX.	UNIT
Output Cut-off Current	KRC101M~106M	$I_{O(OFF)}$	$V_O=50V, V_I=0$	-	-	500	nA
DC Current Gain	KRC101M	$G_I$	$V_O=5V, I_O=10mA$	30	55	-	
	KRC102M			50	80	-	
	KRC103M			70	120	-	
	KRC104M			80	200	-	
	KRC105M			80	200	-	
	KRC106M			80	200	-	
Output Voltage	KRC101M~106M	$V_{O(ON)}$	$I_O=10mA, I_I=0.5mA$	-	0.1	0.3	V
Input Voltage (ON)	KRC101M	$V_{I(ON)}$	$V_O=0.2V, I_O=5mA$	-	1.5	2.0	V
	KRC102M			-	1.8	2.4	
	KRC103M			-	2.1	3.0	
	KRC104M			-	2.8	5.0	
	KRC105M			-	0.8	1.1	
	KRC106M			-	0.9	1.3	
Input Voltage (OFF)	KRC101M~104M	$V_{I(OFF)}$	$V_O=5V, I_O=0.1mA$	1.0	1.2	-	V
	KRC105M~106M			0.5	0.65	-	
Transition Frequency	KRC101M~106M	$f_T$ *	$V_O=10V, I_O=5mA$	-	200	-	MHz
Input Current	KRC101M	$I_I$	$V_I=5V$	-	-	1.8	mA
	KRC102M			-	-	0.88	
	KRC103M			-	-	0.36	
	KRC104M			-	-	0.18	
	KRC105M			-	-	3.6	
	KRC106M			-	-	1.8	

Note : \*Characteristic of Transistor Only

# KRC101M ~ KRC106M

## ELECTRICAL CHARACTERISTICS (Ta=25°C)

CHARACTERISTIC		SYMBOL	TEST CONDITION	MIN.	TYP.	MAX.	UNIT	
Switching Time	Rise Time	KRC101M	V <sub>O</sub> =5V V <sub>IN</sub> =5V R <sub>L</sub> =1kΩ	-	0.03	-	μS	
		KRC102M		-	0.05	-		
		KRC103M		-	0.12	-		
		KRC104M		-	0.22	-		
		KRC105M		-	0.01	-		
		KRC106M		-	0.03	-		
	Storage Time	KRC101M		t <sub>stg</sub>	-	2.0		-
		KRC102M			-	2.0		-
		KRC103M			-	2.0		-
		KRC104M			-	2.0		-
		KRC105M			-	2.0		-
		KRC106M			-	2.0		-
	Fall Time	KRC101M		t <sub>f</sub>	-	0.12		-
		KRC102M			-	0.36		-
		KRC103M			-	0.35		-
		KRC104M			-	0.6		-
		KRC105M			-	0.1		-
		KRC106M			-	0.19		-

# KRC101M~KRC106M

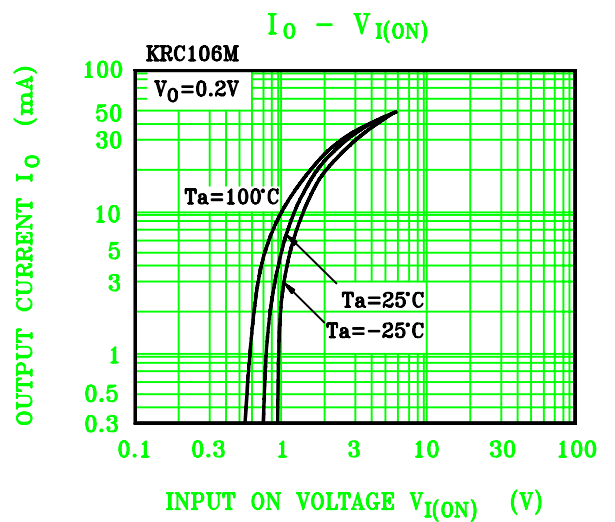
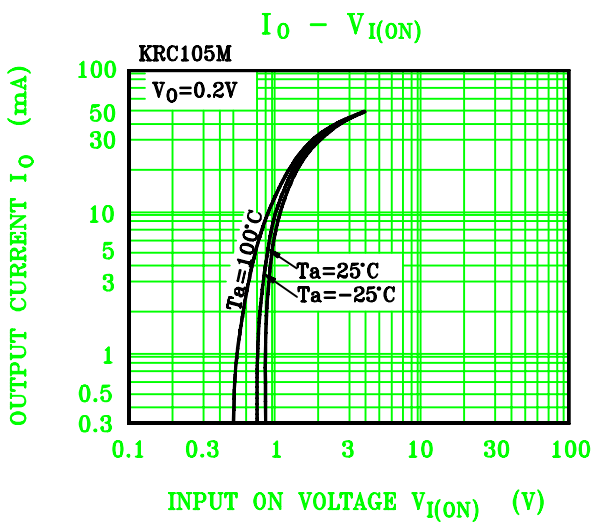
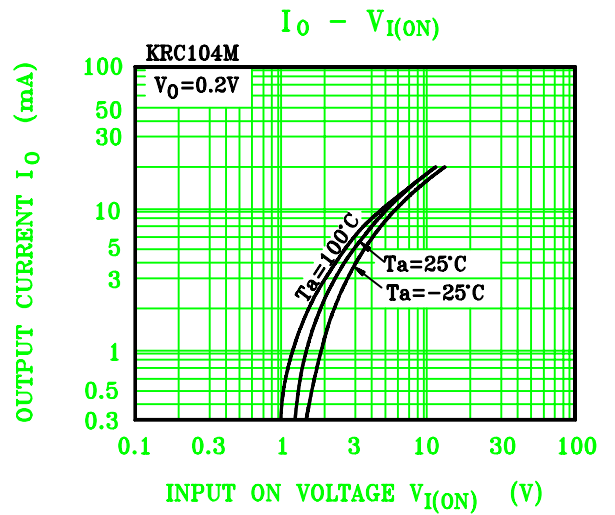
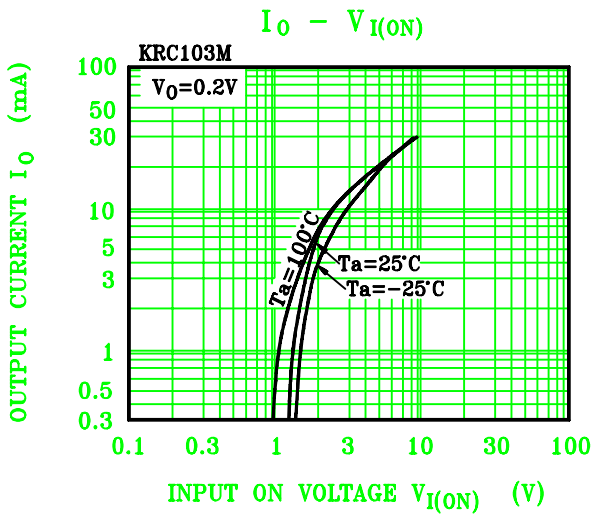
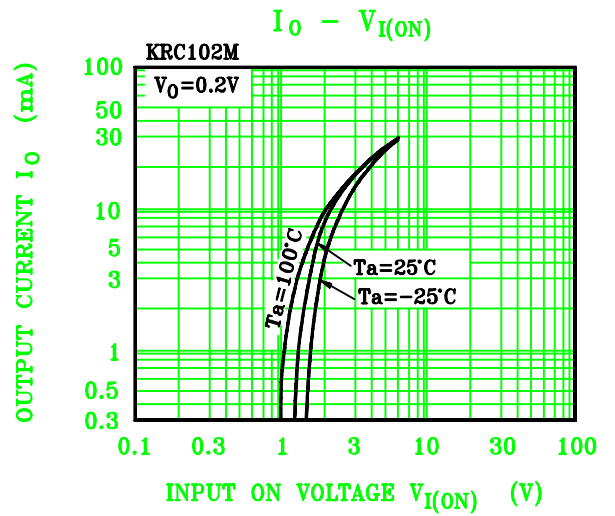
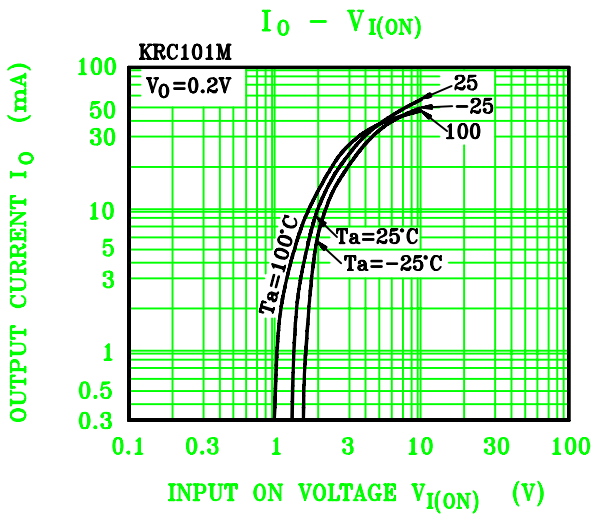

# KRC101M ~ KRC106M

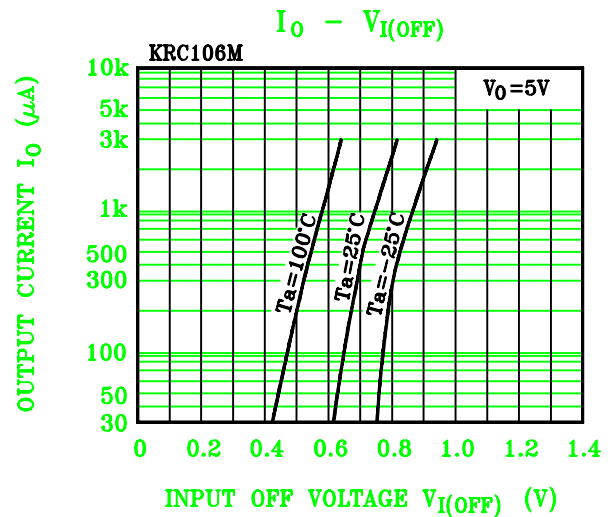
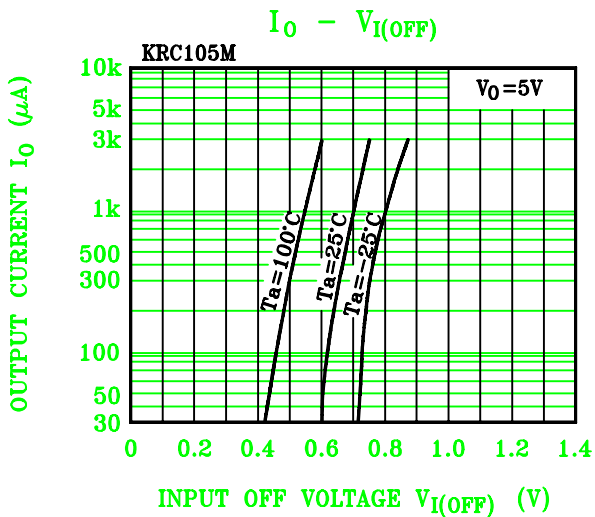
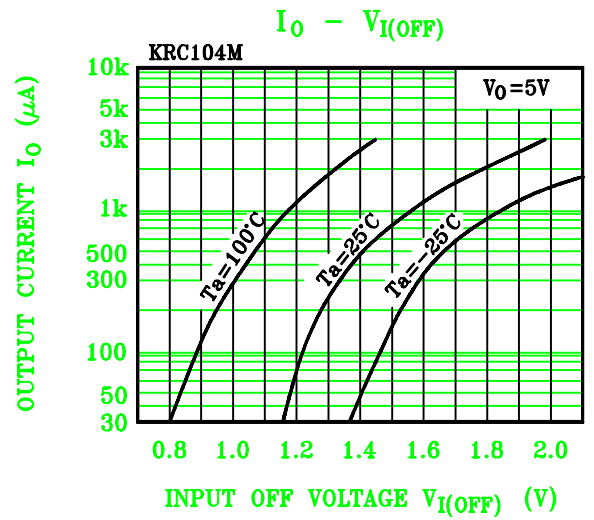
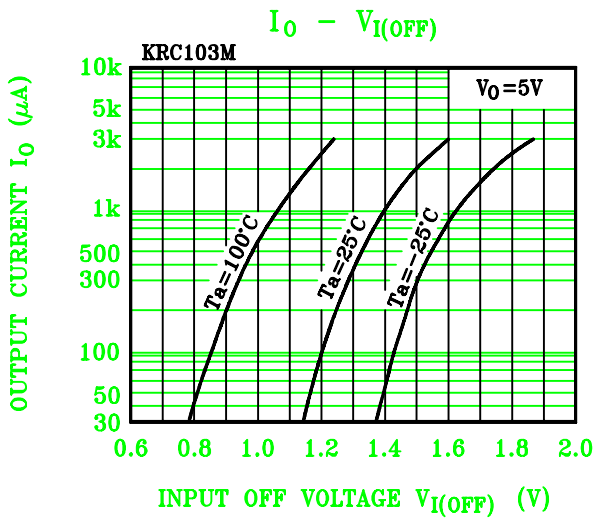
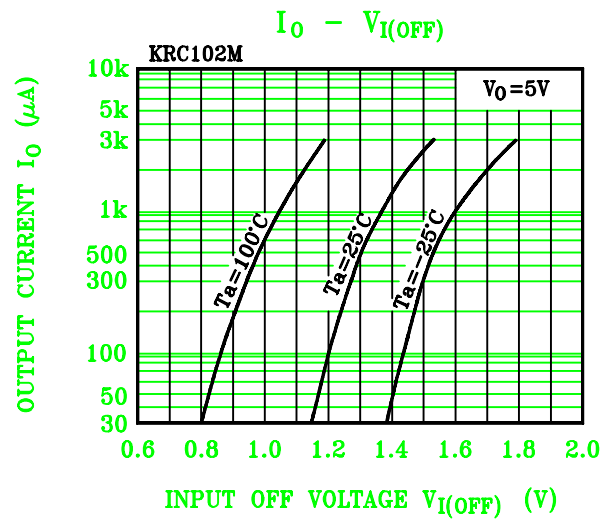
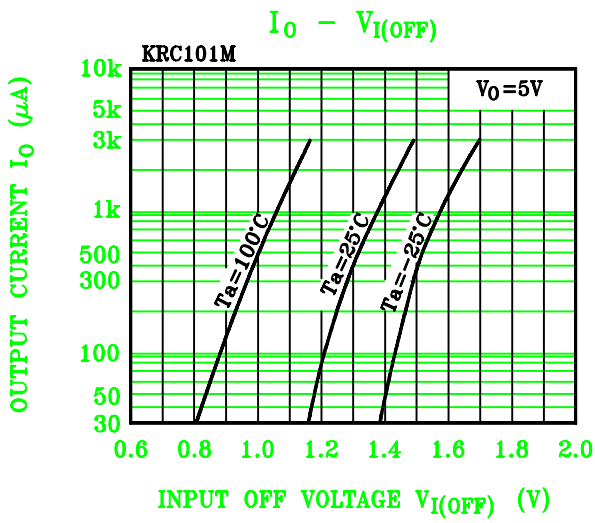

# KRC101M~KRC106M

