

Digital transistors (built-in resistors)

PNP Silicon Surface Mount Transistor with Monolithic Bias Resistor Network

• **Applications**

Inverter, Interface, Driver

• **Features**

- 1) Built-in bias resistors enable the configuration of an inverter circuit without connecting external input resistors (see equivalent circuit).
 - 2) The bias resistors consist of thin-film resistors with complete isolation to allow positive biasing of the input. They also have the advantage of almost completely eliminating parasitic effects.
 - 3) Only the on / off conditions need to be set for operation, making the device design easy.
- We declare that the material of product compliance with RoHS requirements.



• **Equivalent circuit**

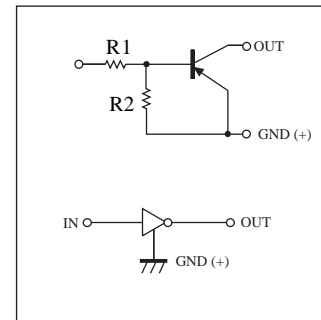

● **Absolute maximum ratings** (Ta=25°C)

Parameter	Symbol	Limits	Unit
Supply voltage	V _{CC}	-50	V
Input voltage	V _{IN}	-30 to +10	V
Output current	I _C	-500	mA
Power dissipation	P _D	200	mW
Junction temperature	T _j	150	°C
Storage temperature	T _{stg}	-55 to +150	°C

DEVICE MARKING AND RESISTOR VALUES

Device	Marking	R1 (K)	R2 (K)	Shipping
DTB201	K6	4.7	4.7	3000/Tape & Reel
DTB201	K6	4.7	4.7	10000/Tape & Reel

● **Electrical characteristics** (Ta=25°C)

Parameter	Symbol	Min.	Typ.	Max.	Unit	Conditions
Input voltage	V _{I(off)}	-	-	-0.5	V	V _{CC} =-5V, I _O =-100μA
	V _{I(on)}	-3	-	-		V _O =-0.3V, I _O =-20mA
Output voltage	V _{O(on)}	-	-0.1	-0.3	V	I _O /I _I =-50mA/-2.5mA
Input current	I _I	-	-	-1.8	mA	V _I =-5V
Output current	I _{O(off)}	-	-	-0.5	μA	V _{CC} =-50V, V _I =0V
DC current gain	G _I	47	-	-	-	V _O =-5V, I _O =-50mA
Input resistance	R ₁	3.29	4.7	6.11	kΩ	-
Resistance ratio	R ₂ /R ₁	0.8	1	1.2	-	-
Transition frequency	f _T □	-	200	-	MHz	V _{CE} =-10V, I _E =50mA, f=100MHz

□ Characteristics of built-in transistor

●Electrical characteristic curves

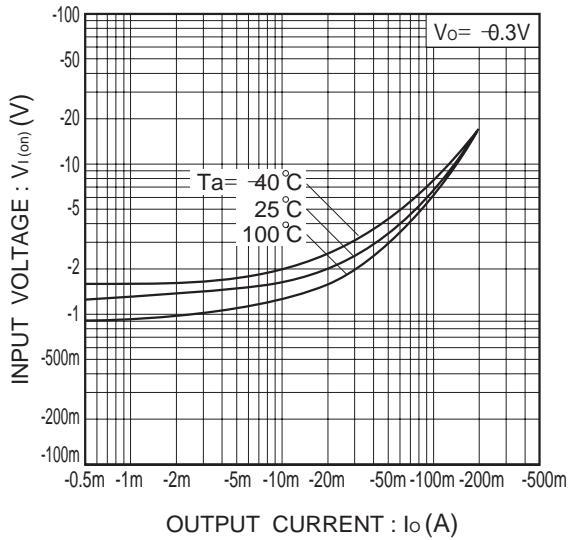

Fig.1 Input voltage vs. output current

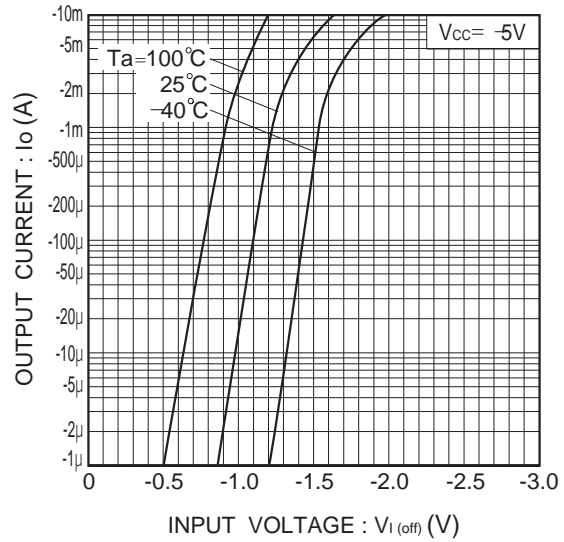

Fig.2 Output current vs. input voltage (OFF characteristics)

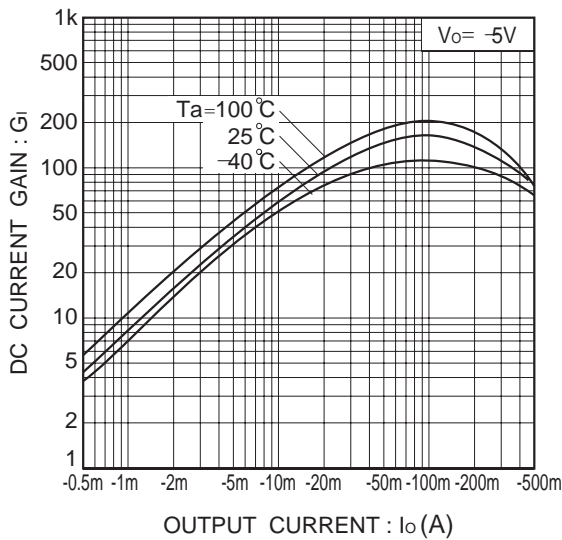

Fig.3 DC current gain vs. output current

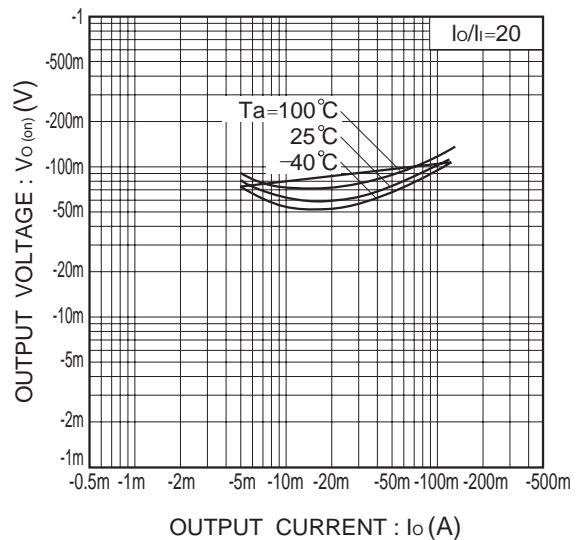
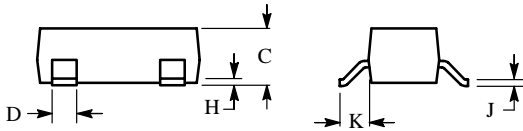
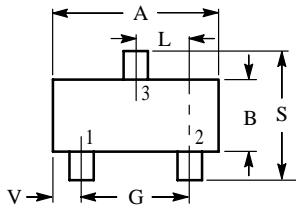

Fig.4 Output voltage vs. output current

SOT-23

NOTES:

1. DIMENSIONING AND TOLERANCING PER ANSI Y14.5M,1982
2. CONTROLLING DIMENSION: INCH.



DIM	INCHES		MILLIMETERS	
	MIN	MAX	MIN	MAX
A	0.1102	0.1197	2.80	3.04
B	0.0472	0.0551	1.20	1.40
C	0.0350	0.0440	0.89	1.11
D	0.0150	0.0200	0.37	0.50
G	0.0701	0.0807	1.78	2.04
H	0.0005	0.0040	0.013	0.100
J	0.0034	0.0070	0.085	0.177
K	0.0140	0.0285	0.35	0.69
L	0.0350	0.0401	0.89	1.02
S	0.0830	0.1039	2.10	2.64
V	0.0177	0.0236	0.45	0.60

PIN 1 BASE
 2 EMITTER
 3 COLLECTOR

