

Digital transistors (built-in resistors)

● Features

- 1) Built-in bias resistors enable the configuration of an inverter circuit without connecting external input resistors.
- 2) The bias resistors consist of thin film resistors with complete isolation to allow negative biasing of the input. They also have the advantage of almost completely eliminating parasitic effects.
- 3) Only the on/off conditions need to be set for operation, making device design easy.

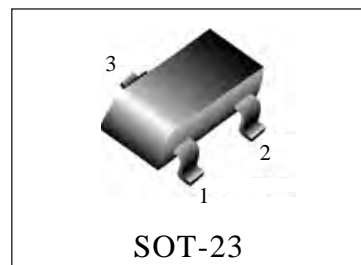

● Device marking and ordering information

Device	Marking	Shipping
DTD102	CA	3000/Tape&Reel

● Absolute maximum ratings (Ta = 25 °C)

Parameter	Symbol	Limits	Unit
Supply voltage	V _{CC}	50	V
Input voltage	V _N	-10~+40	V
Output current	I _C	500	mA
Power dissipation	P _d	200	mW
Junction temperature	T _j	150	°C
Storage temperature	T _{stg}	-55~+150	°C

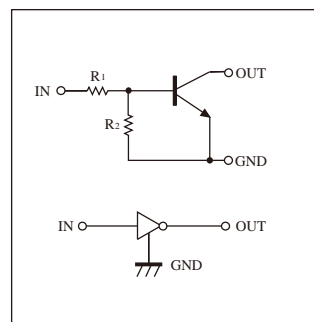

● Electrical characteristics (Ta = 25 °C)

Parameter	Symbol	Min.	Typ.	Max.	Unit	Conditions
Input voltage	V _{I(off)}	—	—	0.5	V	V _{CC} =5V, I _O =100 μA
	V _{I(on)}	3	—	—		V _O =0.3V, I _O =10mA
Output voltage	V _{O(on)}	—	0.1	0.3	V	I _O /I _I =50mA/2.5mA
Input current	I _I	—	—	0.88	mA	V _I =5V
Output current	I _{O(off)}	—	—	0.5	μA	V _{CC} =50V, V _I =0V
DC current gain	G _I	56	—	—	—	V _O =5V, I _O =50mA
Input resistance	R ₁	7	10	13	kΩ	—
Resistance ratio	R ₂ /R ₁	0.8	1	1.2	—	—
Transition frequency	f _T	—	200	—	MHz	V _{CE} =10V, I _E =-50mA, f=100MHz *

* Transition frequency of the device

● Electrical characteristic curves

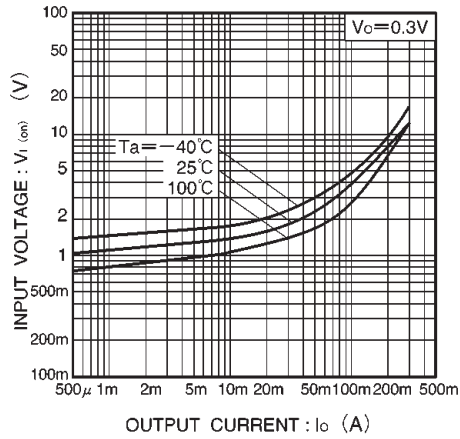

Fig.1 Input voltage vs. output current (ON characteristics)

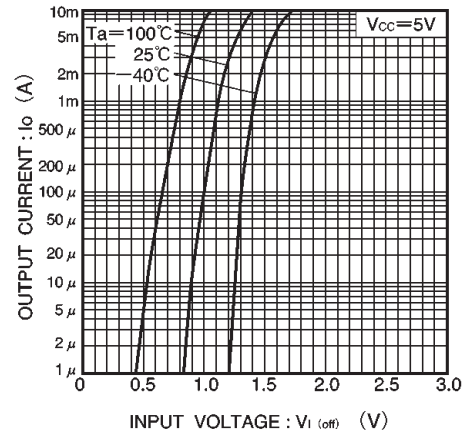

Fig.2 Output current vs. input voltage (OFF characteristics)

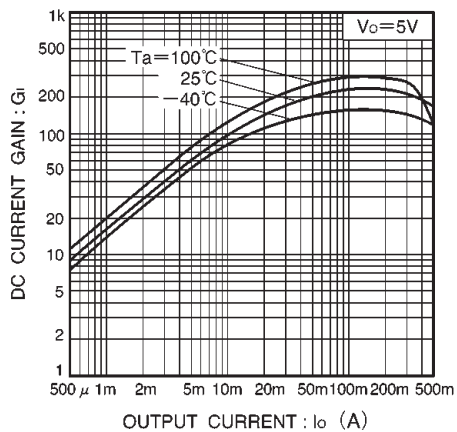

Fig.3 DC current gain vs. output current

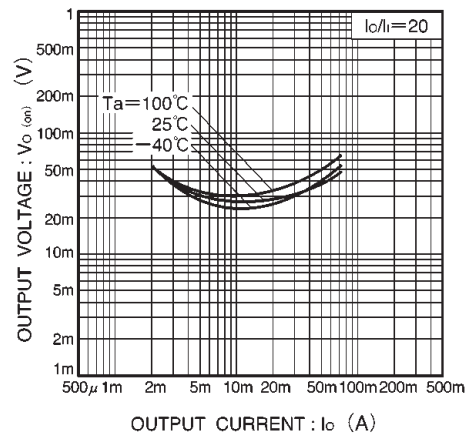
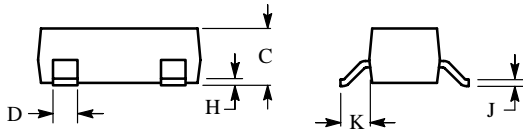
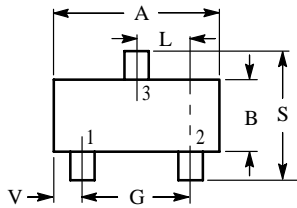

Fig.4 Output voltage vs. output current

SOT-23

NOTES:

1. DIMENSIONING AND TOLERANCING PER ANSI Y14.5M,1982
2. CONTROLLING DIMENSION: INCH.



DIM	INCHES		MILLIMETERS	
	MIN	MAX	MIN	MAX
A	0.1102	0.1197	2.80	3.04
B	0.0472	0.0551	1.20	1.40
C	0.0350	0.0440	0.89	1.11
D	0.0150	0.0200	0.37	0.50
G	0.0701	0.0807	1.78	2.04
H	0.0005	0.0040	0.013	0.100
J	0.0034	0.0070	0.085	0.177
K	0.0140	0.0285	0.35	0.69
L	0.0350	0.0401	0.89	1.02
S	0.0830	0.1039	2.10	2.64
V	0.0177	0.0236	0.45	0.60

PIN 1 BASE
 2 EMITTER
 3 COLLECTOR

