

# SHINDENGEN

## Darlington Transistor

**2SD1791**  
(TP7L10)

**7A NPN**

### OUTLINE DIMENSIONS

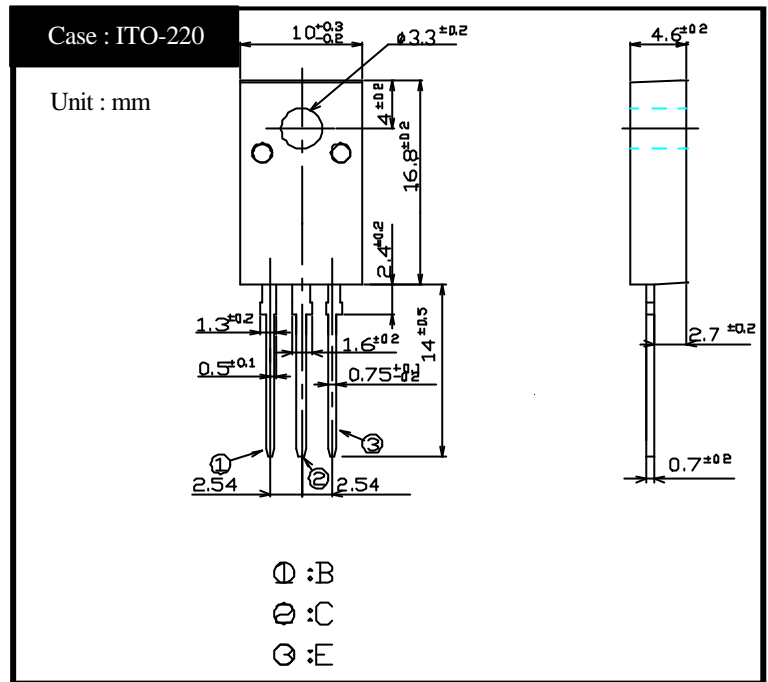

### RATINGS

#### Absolute Maximum Ratings

| Item                         | Symbol           | Conditions                    | Ratings    | Unit |
|------------------------------|------------------|-------------------------------|------------|------|
| Storage Temperature          | T <sub>stg</sub> |                               | -55 ~ +150 |      |
| Junction Temperature         | T <sub>j</sub>   |                               | +150       |      |
| Collector to Base Voltage    | V <sub>CBO</sub> |                               | 100        | V    |
| Collector to Emitter Voltage | V <sub>CEO</sub> |                               | 100        | V    |
| Emitter to Base Voltage      | V <sub>EBO</sub> |                               | 7          | V    |
| Collector Current DC         | I <sub>C</sub>   |                               | 7          | A    |
| Collector Current Peak       | I <sub>CP</sub>  |                               | 10         | A    |
| Base Current DC              | I <sub>B</sub>   |                               | 0.5        | A    |
| Base Current Peak            | I <sub>BP</sub>  |                               | 1.0        | A    |
| Total Transistor Dissipation | P <sub>T</sub>   | T <sub>C</sub> = 25           | 30         | W    |
| Dielectric Strength          | V <sub>dis</sub> | Terminals to case AC 1 minute | 2          | kV   |
| Mounting Torque              | TOR              | (Recommended torque : 0.3N·m) | 0.5        | N·m  |

#### Electrical Characteristics (T<sub>c</sub>=25 )

| Item                                    | Symbol               | Conditions  | Ratings    | Unit |
|---|----------------------|---|------------|------|
| Collector Cutoff Current                | I <sub>CBO</sub>     | V <sub>CB</sub> = 100V  | Max 0.1    | mA   |
|   | I <sub>CEO</sub>     | V <sub>CE</sub> = 100V  | Max 0.1    |      |
| Emitter Cutoff Current                  | I <sub>EBO</sub>     | V <sub>EB</sub> = 7V  | Max 5      | mA   |
| DC Current Gain                         | h <sub>FE</sub>      | V <sub>CE</sub> = 3V, I <sub>C</sub> = 3A   | Min 1,500  |      |
|   |                      |   | Max 30,000 |      |
| Collector to Emitter Saturation Voltage | V <sub>CE(sat)</sub> | I <sub>C</sub> = 3A   | Max 1.5    | V    |
| Base to Emitter Saturation Voltage      | V <sub>BE(sat)</sub> | I <sub>B</sub> = 5mA  | Max 2.0    | V    |
| Thermal Resistance                      | θ <sub>jc</sub>      | Junction to case  | Max 4.17   | /W   |
| Transition Frequency                    | f <sub>T</sub>       | V <sub>CE</sub> = 10V, I <sub>C</sub> = 0.7A  | TYP 20     | MHz  |
| Turn on Time                            | t <sub>on</sub>      |   | Max 2      | μs   |
| Storage Time                            | t <sub>s</sub>       | I <sub>C</sub> = 3A<br>I <sub>B1</sub> = I <sub>B2</sub> = 5mA<br>R <sub>L</sub> = 10 | Max 12     |      |
| Fall Time                               | t <sub>f</sub>       | V <sub>BB2</sub> = 4V   | Max 5      |      |

# 2SD1791

$h_{FE} - I_C$

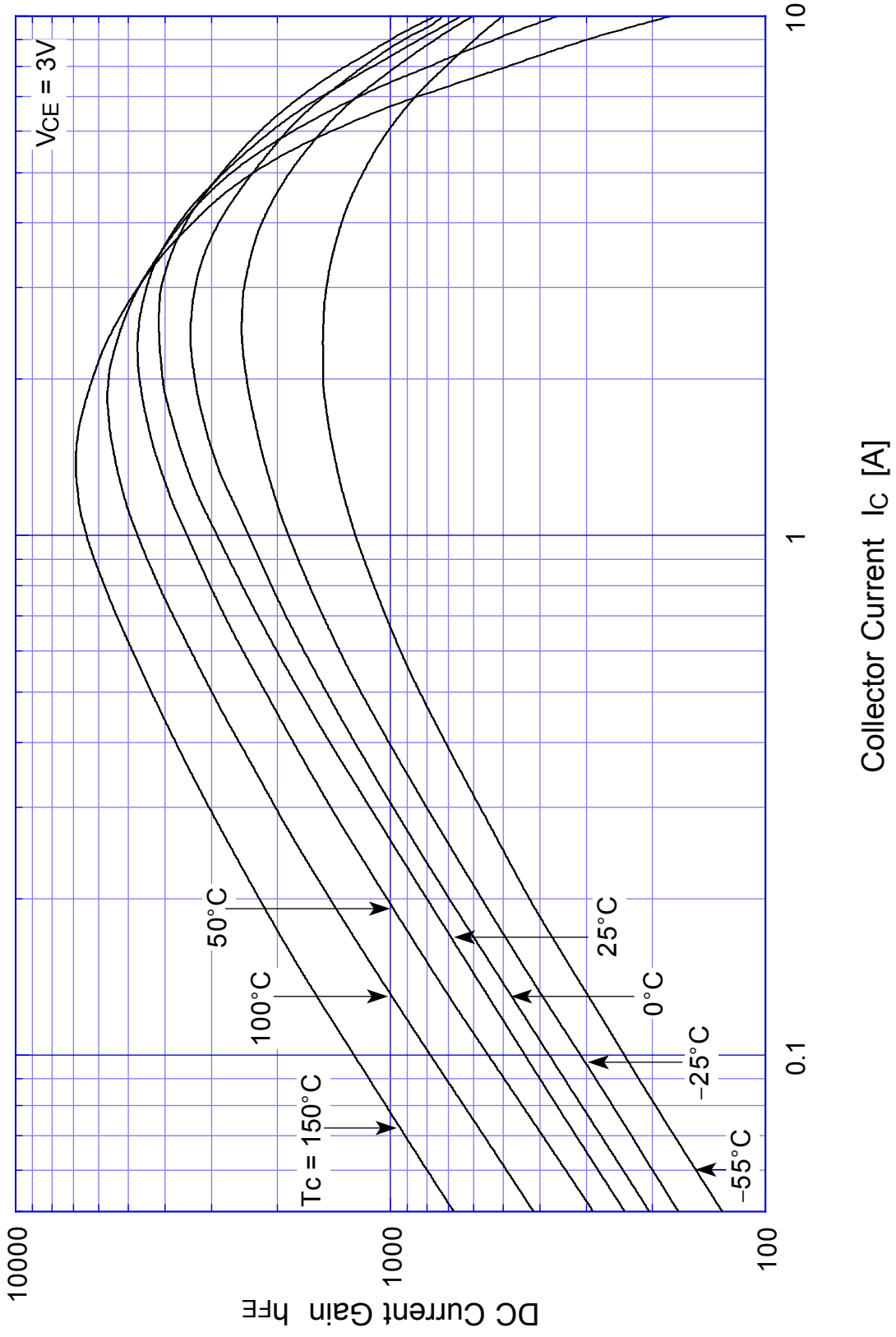

# 2SD1791 Saturation Voltage

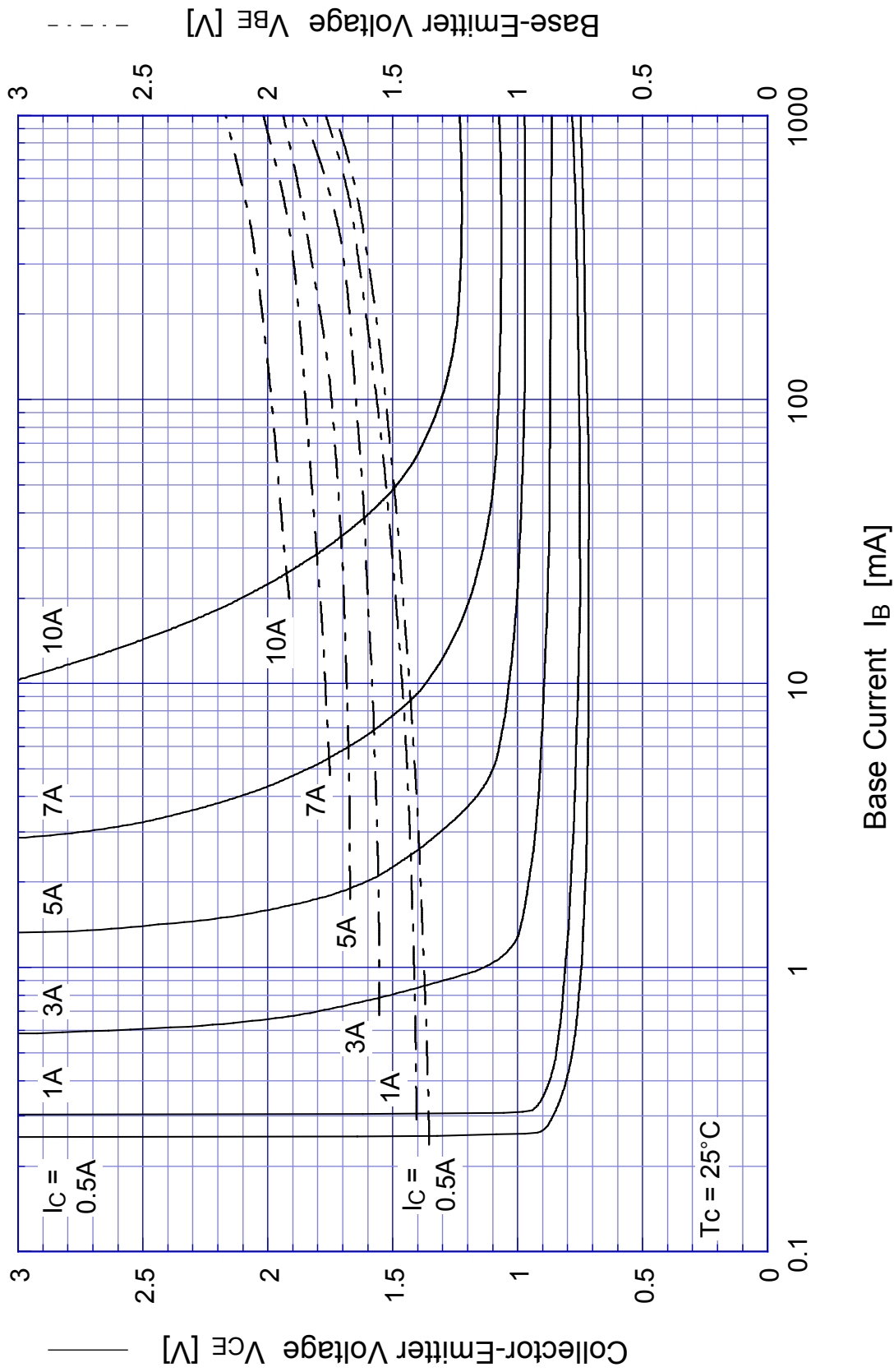

# 2SD1791

## Switching Time - $I_C$

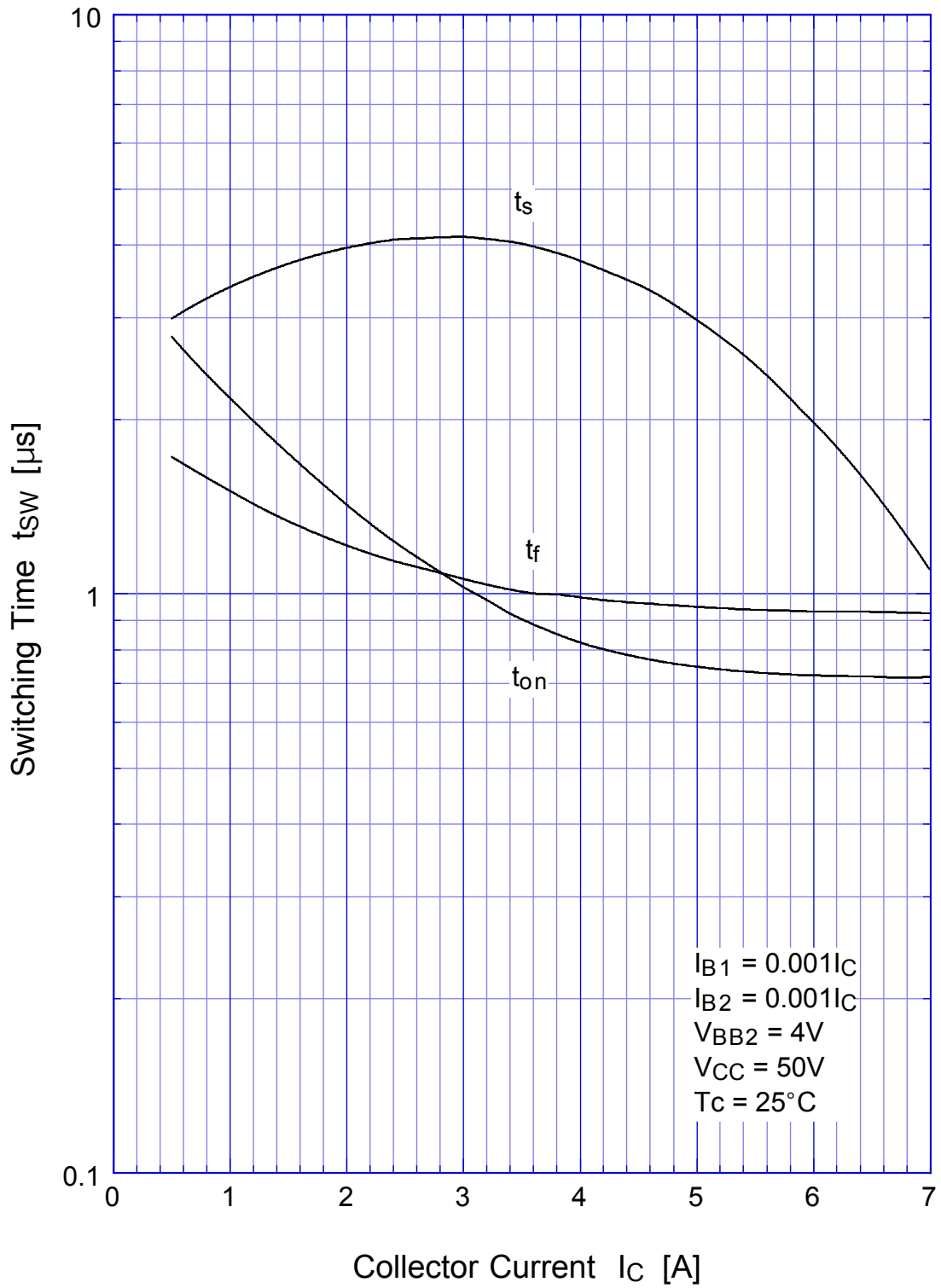

# 2SD1791

## Switching Time - Tc

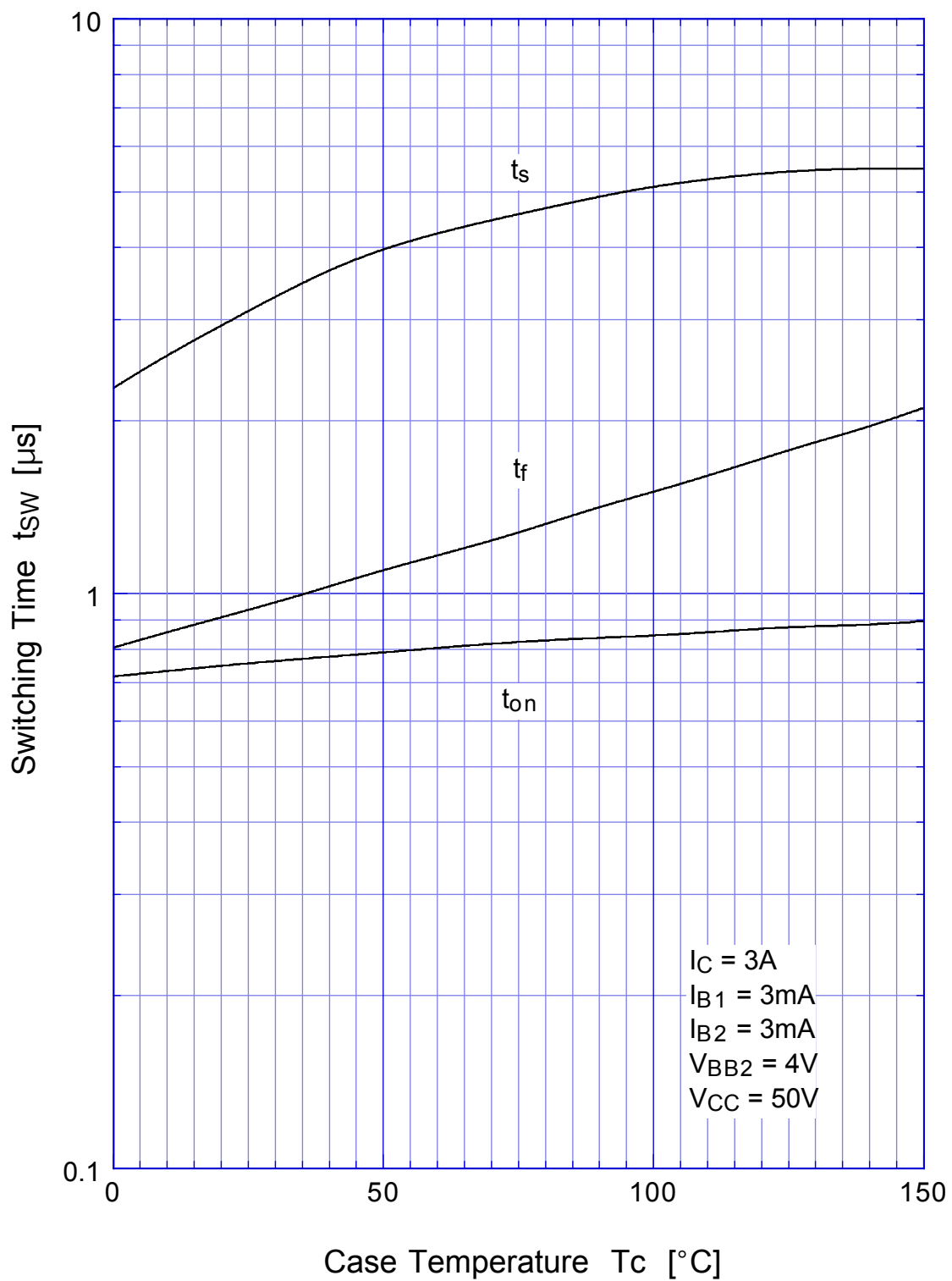

# 2SD1791 Transient Thermal Impedance

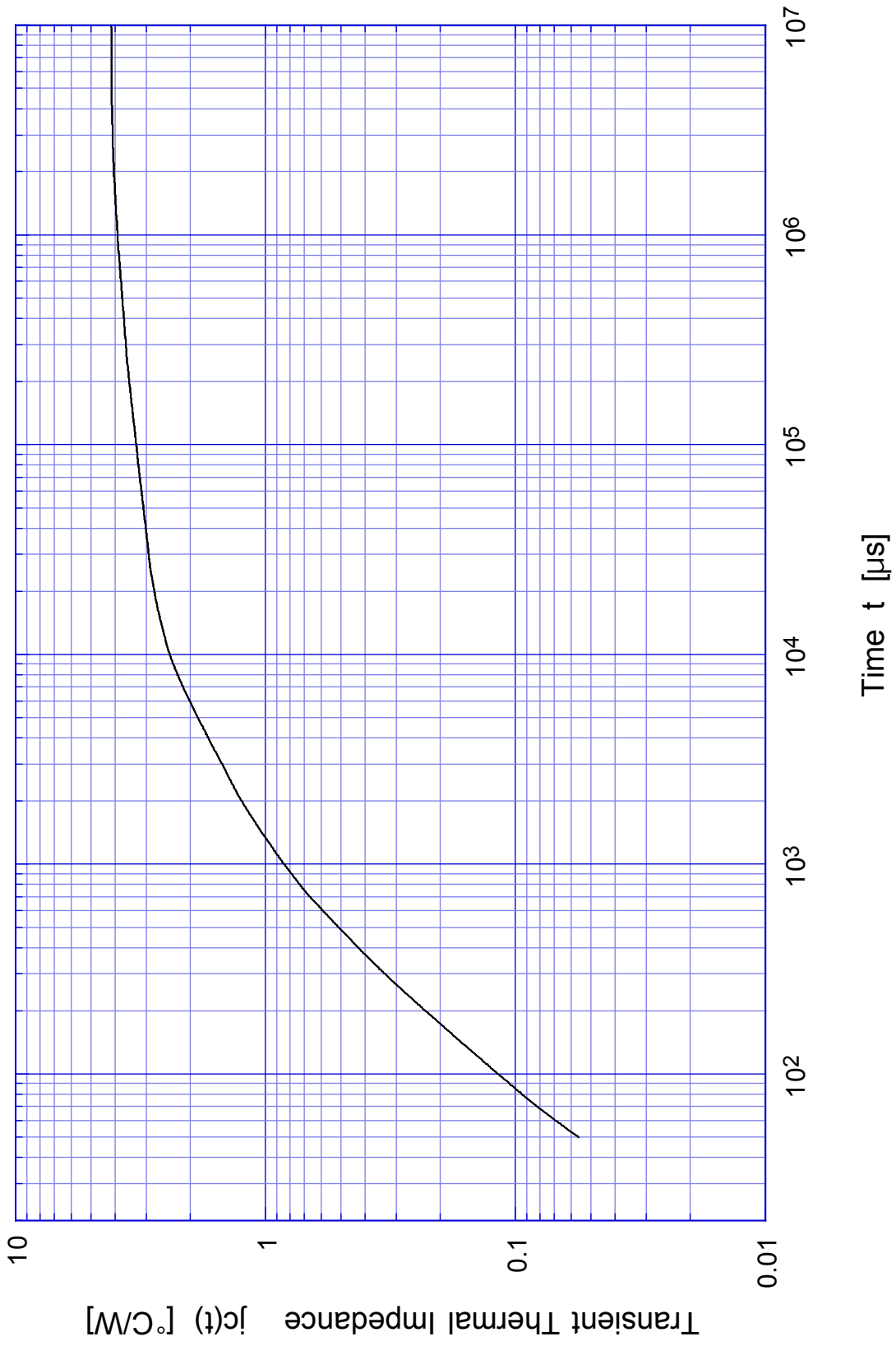

# 2SD1791

# Forward Bias SOA

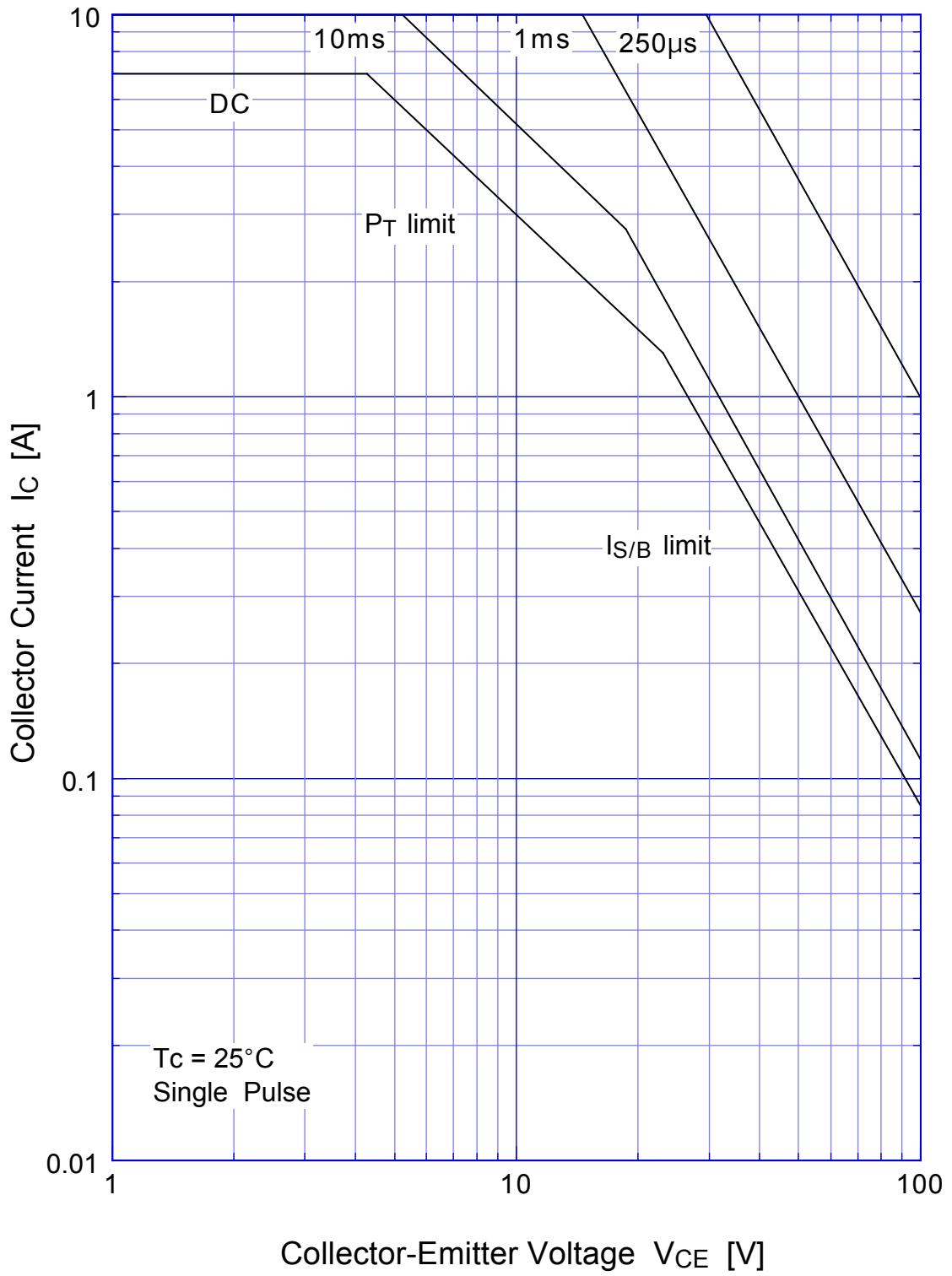

## 2SD1791 Collector Current Derating

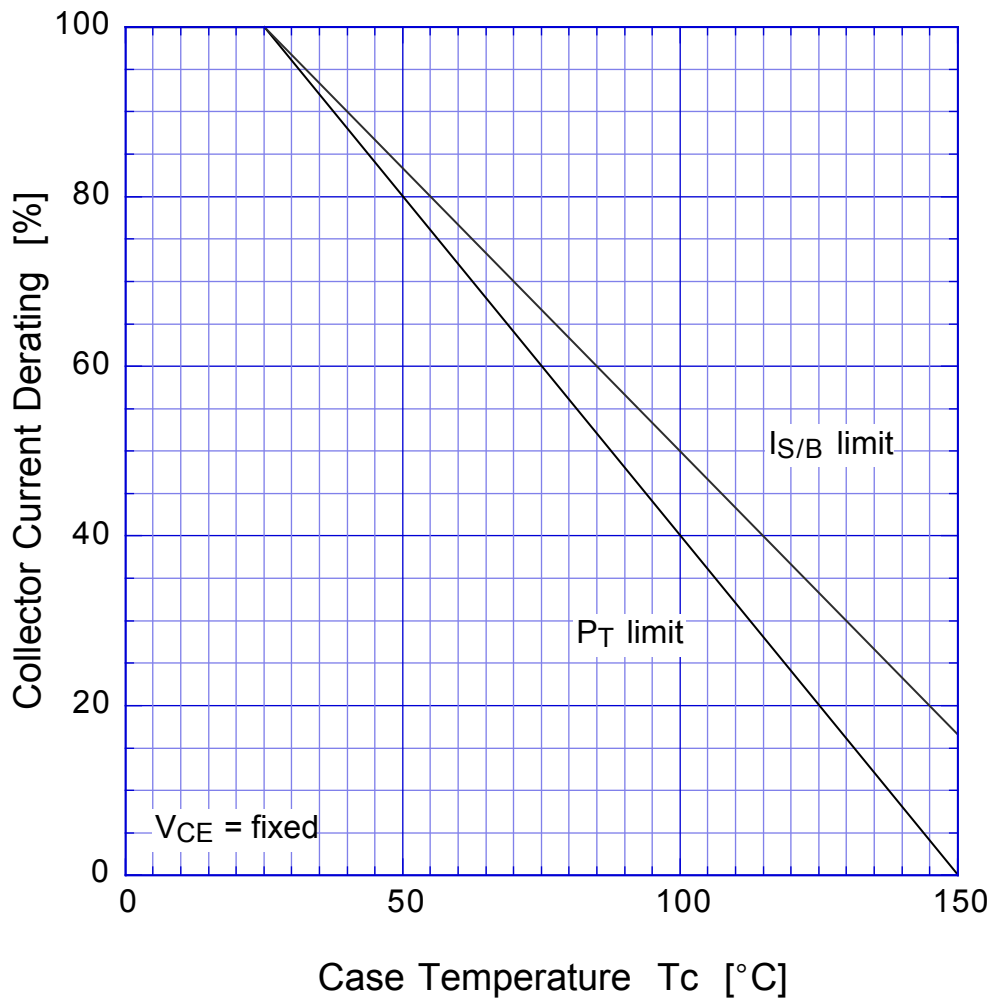



2SD1791

Reverse Bias SOA

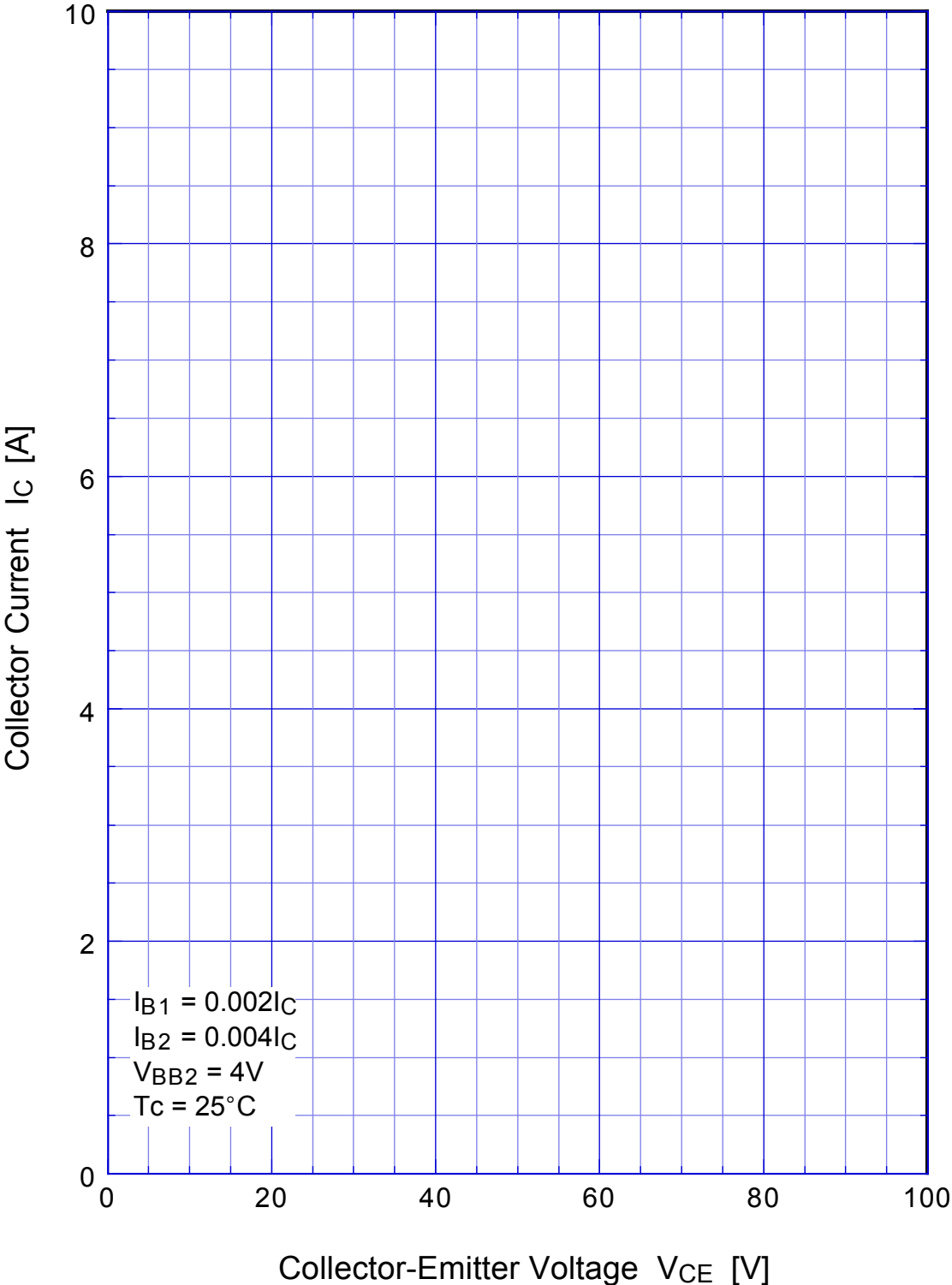

**This datasheet has been downloaded from:**

**[www.EEworld.com.cn](http://www.EEworld.com.cn)**

**Free Download**

**Daily Updated Database**

**100% Free Datasheet Search Site**

**100% Free IC Replacement Search Site**

**Convenient Electronic Dictionary**

**Fast Search System**

**[www.EEworld.com.cn](http://www.EEworld.com.cn)**