

NPN Transistors

2SD1367-HF

■ Features

- Low frequency power amplifier
- Complementary to 2SB1001-HF
- Pb-Free Package May be Available. The G-Suffix Denotes a Pb-Free Lead Finish

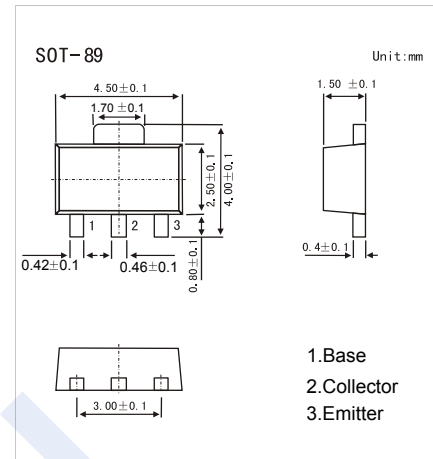

■ Absolute Maximum Ratings $T_a = 25^\circ\text{C}$

Parameter	Symbol	Rating	Unit
Collector - Base Voltage	V_{CB0}	20	V
Collector - Emitter Voltage	V_{CE0}	16	
Emitter - Base Voltage	V_{EB0}	6	
Collector Current - Continuous	I_C	2	A
Collector Current - Pulse (Note.1)	I_{CP}	3	
Collector Power Dissipation	P_C	1	W
Junction Temperature	T_J	150	$^\circ\text{C}$
Storage Temperature Range	T_{stg}	-55 to 150	

Note.1: $PW \leq 10$ ms, Duty cycle $\leq 20\%$.

■ Electrical Characteristics $T_a = 25^\circ\text{C}$

Parameter	Symbol	Test Conditions	Min	Typ	Max	Unit
Collector- base breakdown voltage	V_{CB0}	$I_C = 100 \mu\text{A}, I_E = 0$	20			V
Collector- emitter breakdown voltage	V_{CE0}	$I_C = 1 \text{ mA}, R_{BE} = \infty$	16			
Emitter - base breakdown voltage	V_{EB0}	$I_E = 100 \mu\text{A}, I_C = 0$	6			
Collector-base cut-off current	I_{CB0}	$V_{CB} = 16 \text{ V}, I_E = 0$			0.1	μA
Emitter cut-off current	I_{EB0}	$V_{EB} = 5 \text{ V}, I_C = 0$			0.1	
Collector-emitter saturation voltage	$V_{CE(sat)}$	$I_C = 1 \text{ A}, I_B = 100 \text{ mA}$		0.15	0.3	V
Base - emitter saturation voltage	$V_{BE(sat)}$	$I_C = 1 \text{ A}, I_B = 100 \text{ mA}$		0.9	1.2	
DC current gain	h_{FE}	$V_{CE} = 2 \text{ V}, I_C = 0.1 \text{ A}$	100		500	
Collector output capacitance	C_{ob}	$V_{CB} = 10 \text{ V}, I_E = 0, f = 1 \text{ MHz}$		20		pF
Transition frequency	f_T	$V_{CE} = 2 \text{ V}, I_C = 10 \text{ mA}$		100		MHz

■ Classification of h_{FE}

Type	2SD1367-A-HF	2SD1367-B-HF	2SD1367-C-HF
Range	100-200	160-320	250-500
Marking	BA_F	BB_F	BC_F

NPN Transistors

2SD1367-HF

■ Typical Characteristics

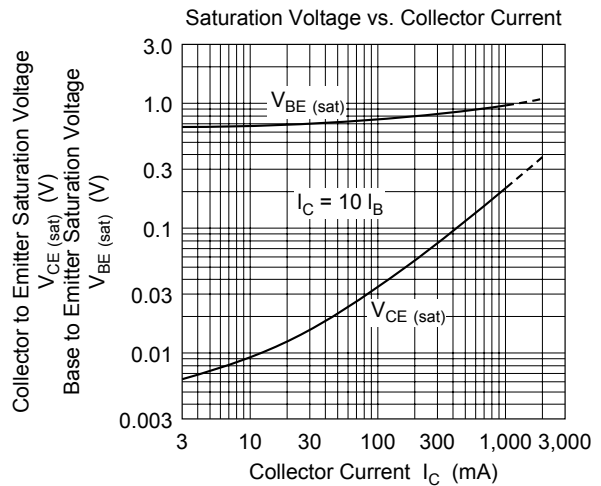
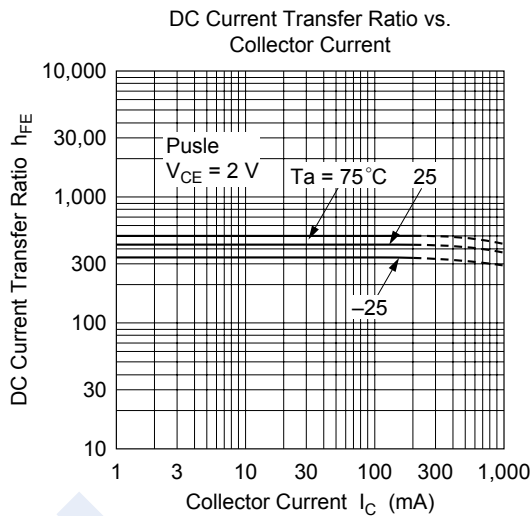
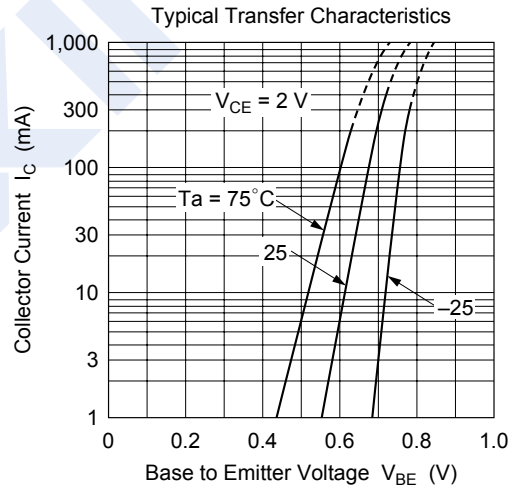
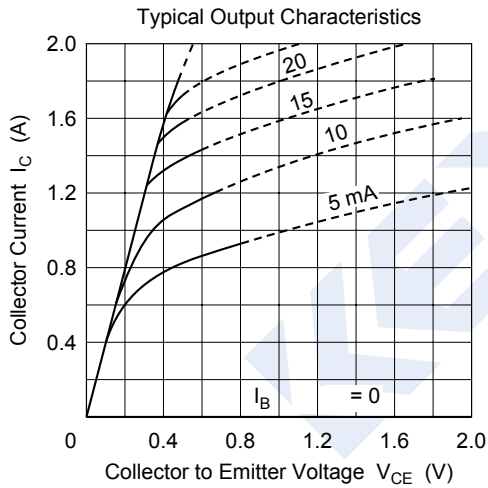
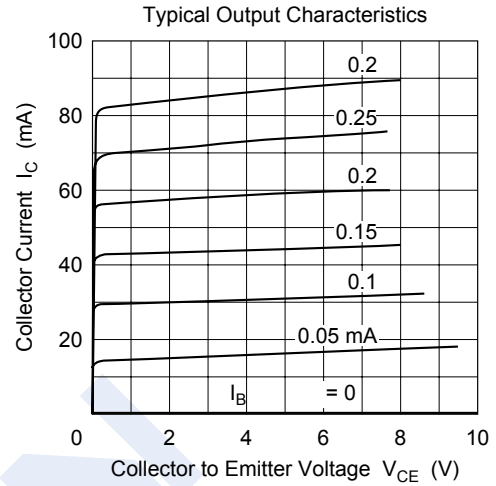
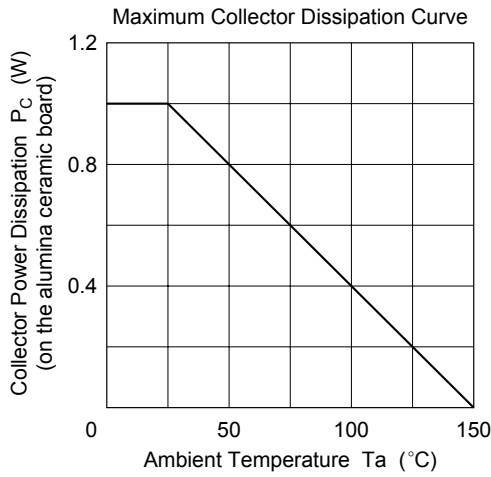

NPN Transistors

2SD1367-HF

■ Typical Characteristics

