

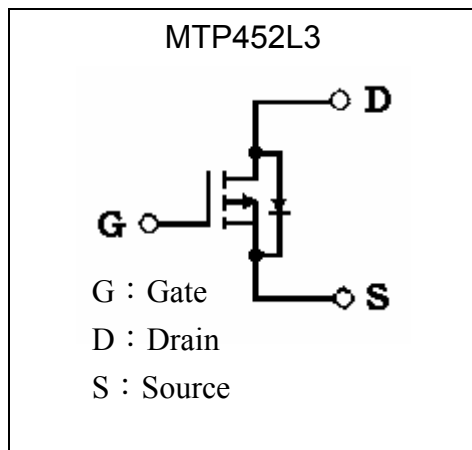
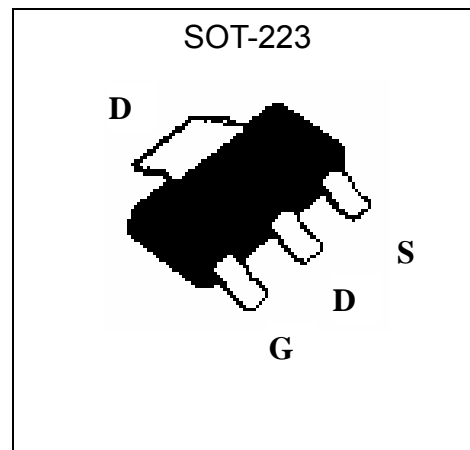
**P-Channel Enhancement Mode Power MOSFET**

# MTP452L3

$BV_{DSS}$	-30V
$R_{DSON(MAX)}$	55m $\Omega$
$I_D$	-6A

**Features**

- Simple Drive Requirement
- Low On-resistance
- Fast switching Characteristic
- Pb-free lead plating package

**Symbol**

**Outline**

**Absolute Maximum Ratings** ( $T_a=25^\circ\text{C}$ )

Parameter	Symbol	Limits	Unit
Drain-Source Voltage	$V_{DS}$	-30	V
Gate-Source Voltage	$V_{GS}$	$\pm 20$	V
Continuous Drain Current @ $T_A=25^\circ\text{C}$	$I_D$	-6.0 *1	A
Continuous Drain Current @ $T_A=70^\circ\text{C}$	$I_D$	-4.8 *1	A
Pulsed Drain Current	$I_{DM}$	-20 *1	A
Total Power Dissipation ( $T_A=25^\circ\text{C}$ )	$P_d$	2.7	W
Linear Derating Factor		0.02	W/ $^\circ\text{C}$
Operating Junction and Storage Temperature	$T_j, T_{stg}$	-55~+150	$^\circ\text{C}$
Thermal Resistance, Junction-to-ambient, max	$R_{th,j-a}$	45 *2	$^\circ\text{C}/\text{W}$

Note : \*1. Pulse width limited by maximum junction temperature

 \*2. Surface mounted on 1 in<sup>2</sup> copper pad of FR-4 board; 120 $^\circ\text{C}/\text{W}$  when mounted on minimum copper pad



**Characteristics (Tj=25°C, unless otherwise specified)**

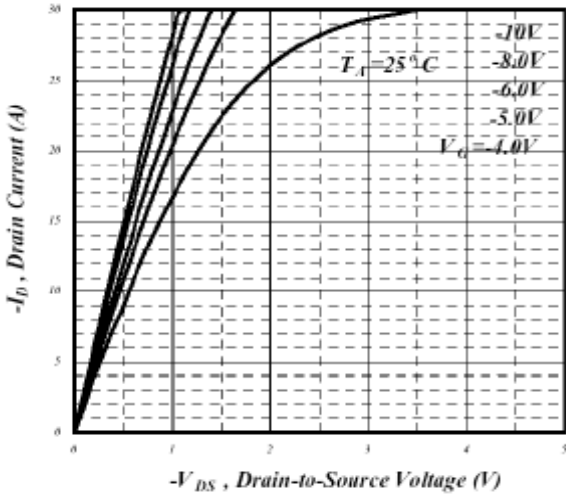
Symbol	Min.	Typ.	Max.	Unit	Test Conditions
<b>Static</b>					
BV <sub>DSS</sub>	-30	-	-	V	V <sub>GS</sub> =0, I <sub>D</sub> =-250μA
ΔBV <sub>DSS</sub> /ΔT <sub>j</sub>	-	-0.02	-	V/°C	Reference to 25°C, I <sub>D</sub> =-1mA
V <sub>GS(th)</sub>	-1.0	-	-3.0	V	V <sub>DS</sub> = V <sub>GS</sub> , I <sub>D</sub> =-250μA
G <sub>FS</sub>	-	10	-	S	V <sub>DS</sub> = -10V, I <sub>D</sub> =-5.3A
I <sub>GSS</sub>	-	-	±100	nA	V <sub>GS</sub> =±20
I <sub>DSS</sub>	-	-	-1	μA	V <sub>DS</sub> = -30V, V <sub>GS</sub> = 0
I <sub>DSS</sub>	-	-	-25	μA	V <sub>DS</sub> = -24V, V <sub>GS</sub> = 0, T <sub>j</sub> =70°C
*R <sub>DS(ON)</sub>	-	45	55	mΩ	V <sub>GS</sub> = -10V, I <sub>D</sub> =-5.3A
*R <sub>DS(ON)</sub>	-	75	100	mΩ	V <sub>GS</sub> = -4.5V, I <sub>D</sub> =-4.2A
<b>Dynamic</b>					
*Q <sub>g</sub>	-	9.2	16	nC	I <sub>D</sub> =-5.3A, V <sub>DS</sub> =-24V, V <sub>GS</sub> =-4.5V
*Q <sub>gs</sub>	-	2.8	-		
*Q <sub>gd</sub>	-	5.2	-		
*t <sub>d(ON)</sub>	-	11	-	ns	V <sub>DS</sub> =-15V, I <sub>D</sub> =-1A, V <sub>GS</sub> =-10V, R <sub>G</sub> =6Ω, R <sub>D</sub> =15Ω
*t <sub>r</sub>	-	8	-		
*t <sub>d(OFF)</sub>	-	25	-		
*t <sub>f</sub>	-	17	-		
C <sub>iss</sub>	-	507	912	pF	V <sub>GS</sub> =0V, V <sub>DS</sub> =-15V, f=1MHz
C <sub>oss</sub>	-	222	-		
C <sub>rss</sub>	-	158	-		
<b>Source-Drain Diode</b>					
*V <sub>SD</sub>	-	-	-1.2	V	I <sub>S</sub> =-2.3A, V <sub>GS</sub> =0V
*t <sub>rr</sub>	-	29	-	ns	I <sub>S</sub> =-5.3A, V <sub>GS</sub> =0, dI/dt=100A/μs
*Q <sub>rr</sub>	-	20	-	nC	

\*Pulse Test : Pulse Width ≤300μs, Duty Cycle ≤2%

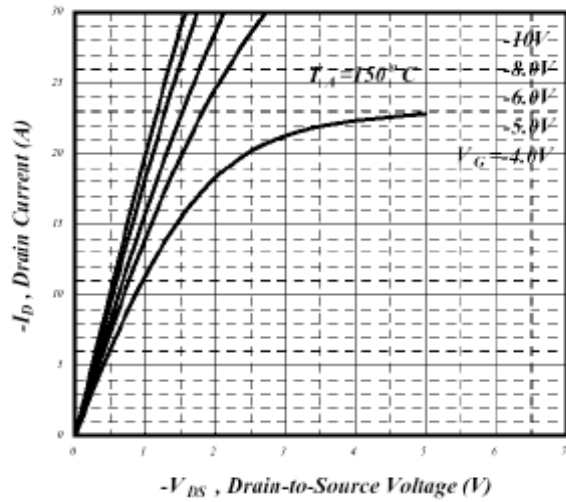
**Ordering Information**

Device	Package	Shipping	Marking
MTP452L3	SOT-223 (Pb-free lead plating package)	2500 pcs / Tape & Reel	452

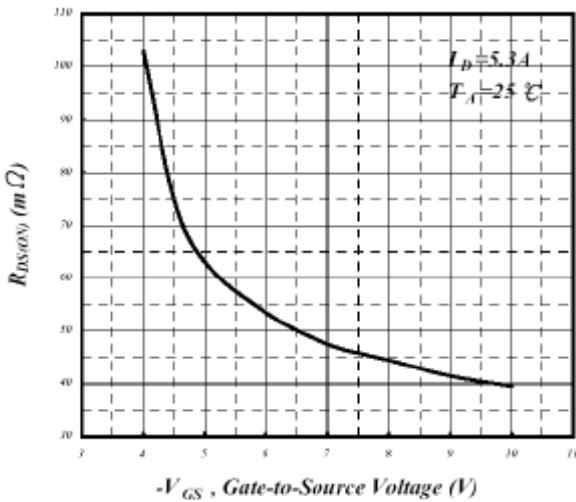
**Typical Characteristics**



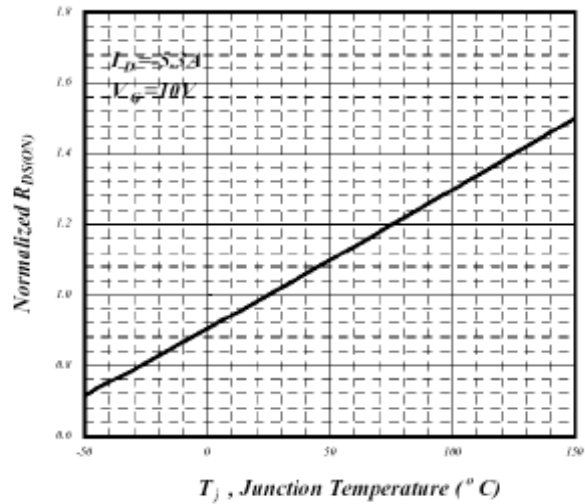
**Fig 1. Typical Output Characteristics**



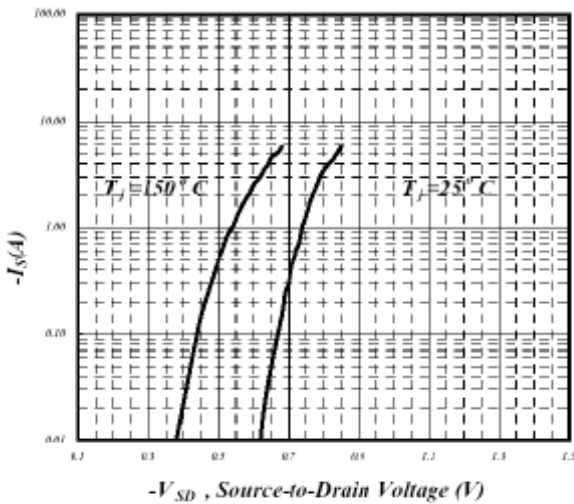
**Fig 2. Typical Output Characteristics**



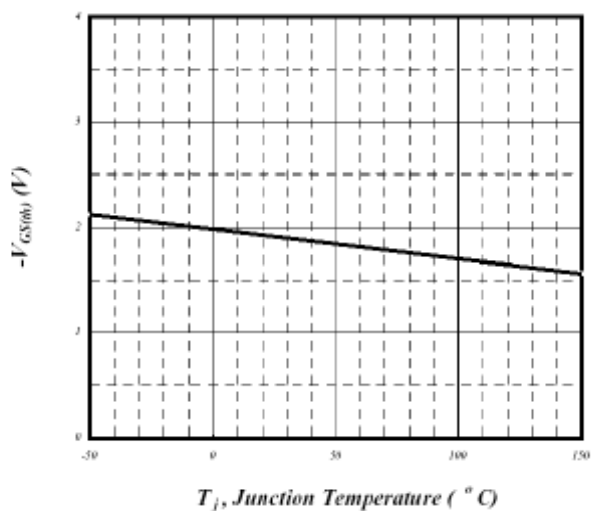
**Fig 3. On-Resistance v.s. Gate Voltage**



**Fig 4. Normalized On-Resistance v.s. Junction Temperature**

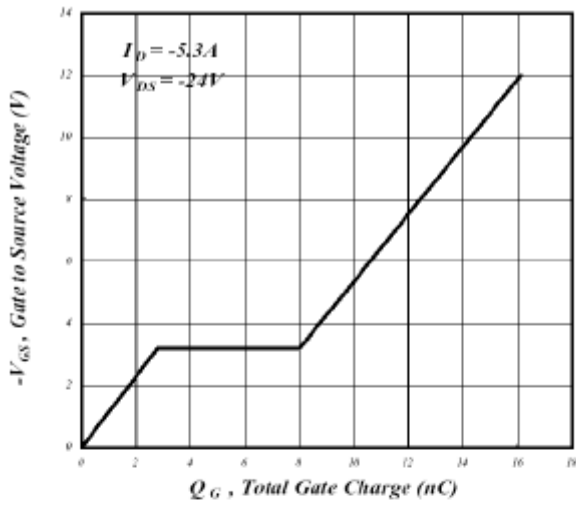


**Fig 5. Forward Characteristics of Reverse Diode**

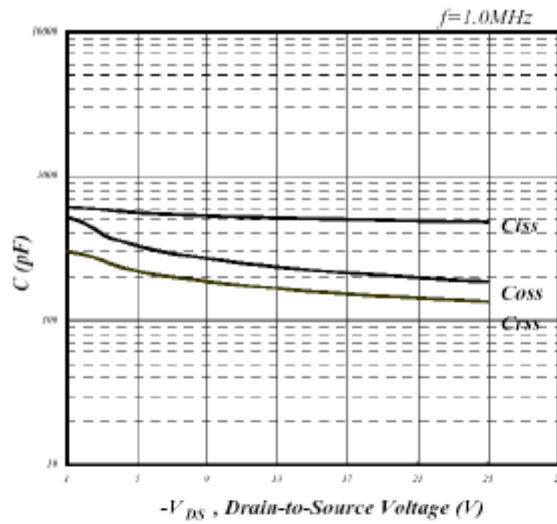


**Fig 6. Gate Threshold Voltage v.s. Junction Temperature**

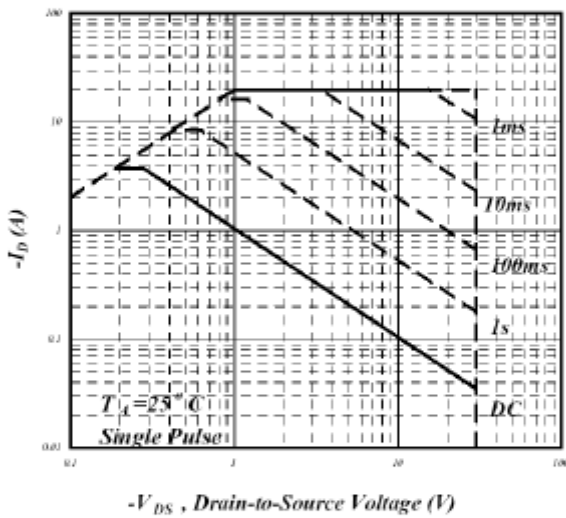
**Typical Characteristics(Cont.)**



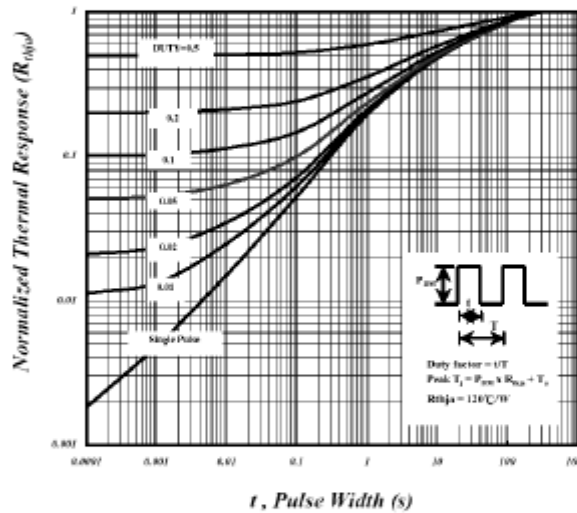
**Fig 7. Gate Charge Characteristics**



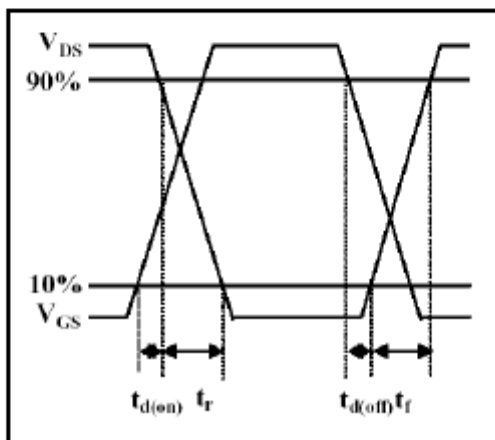
**Fig 8. Typical Capacitance Characteristics**



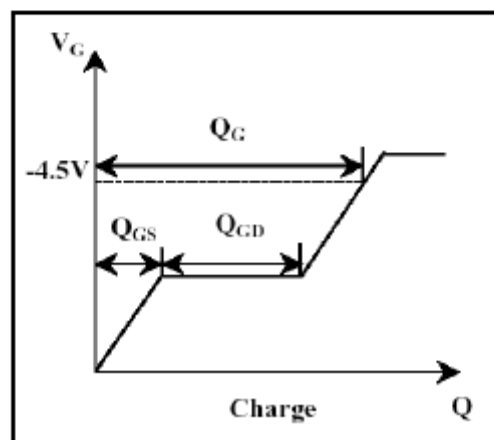
**Fig 9. Maximum Safe Operating Area**



**Fig 10. Effective Transient Thermal Impedance**

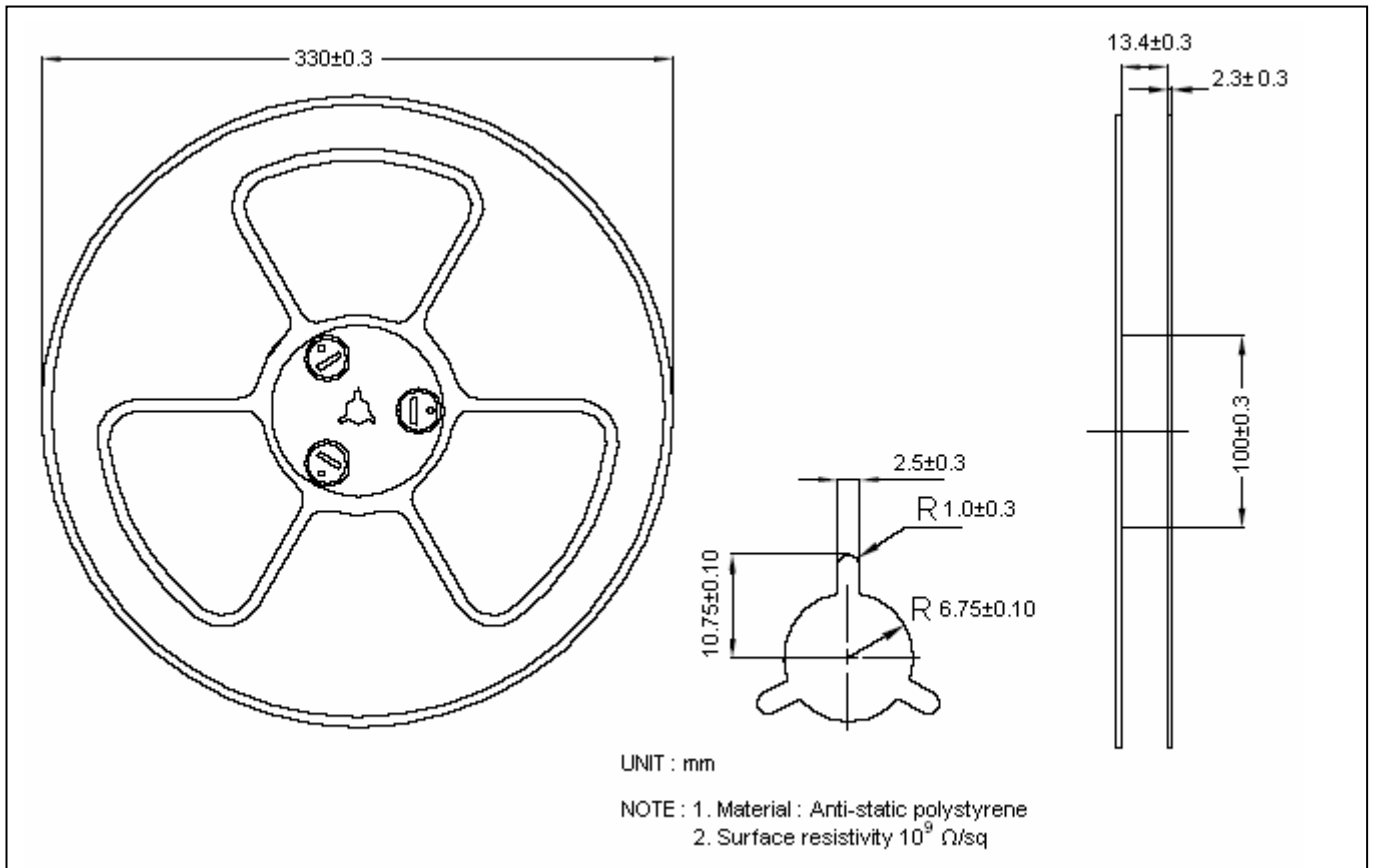


**Fig 11. Switching Time Circuit**

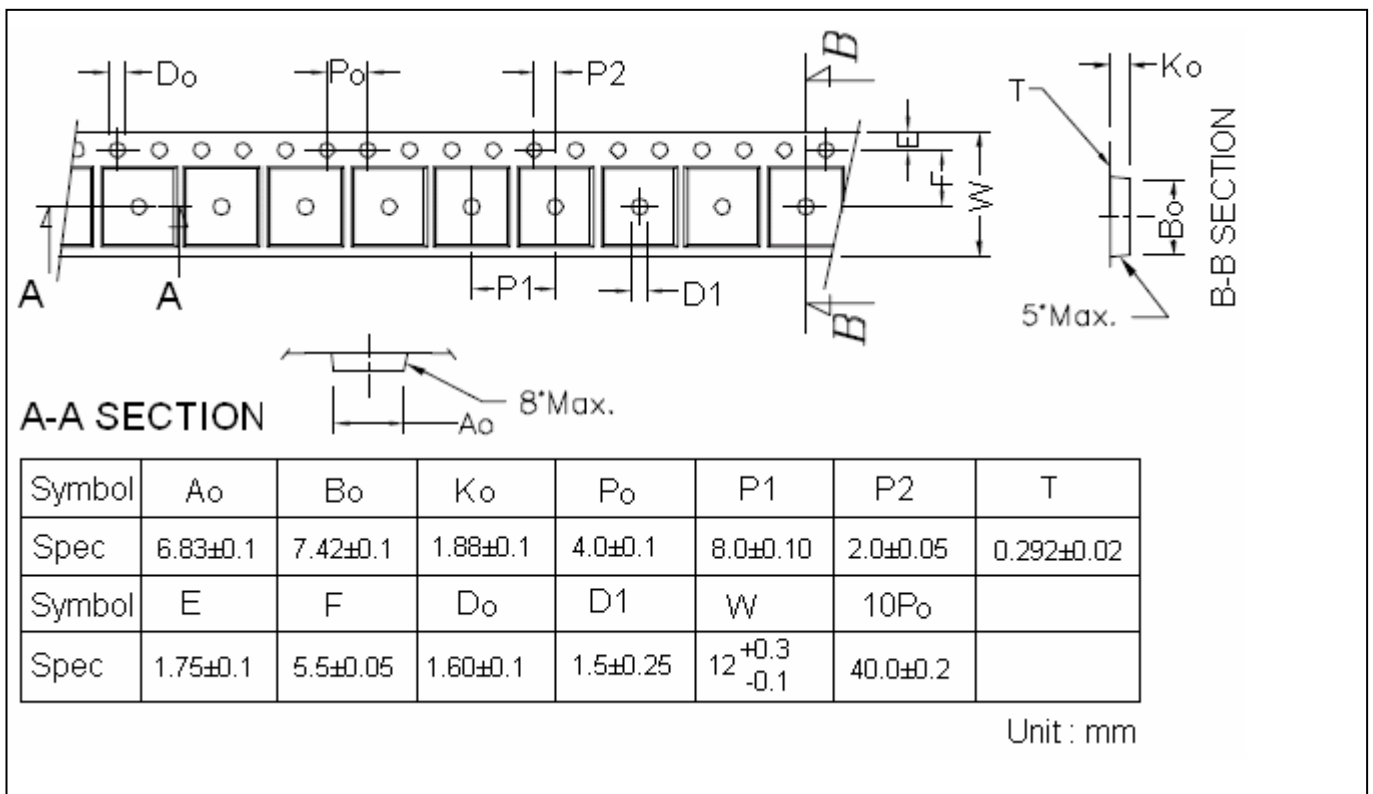


**Fig 12. Gate Charge Waveform**

**Reel Dimension**



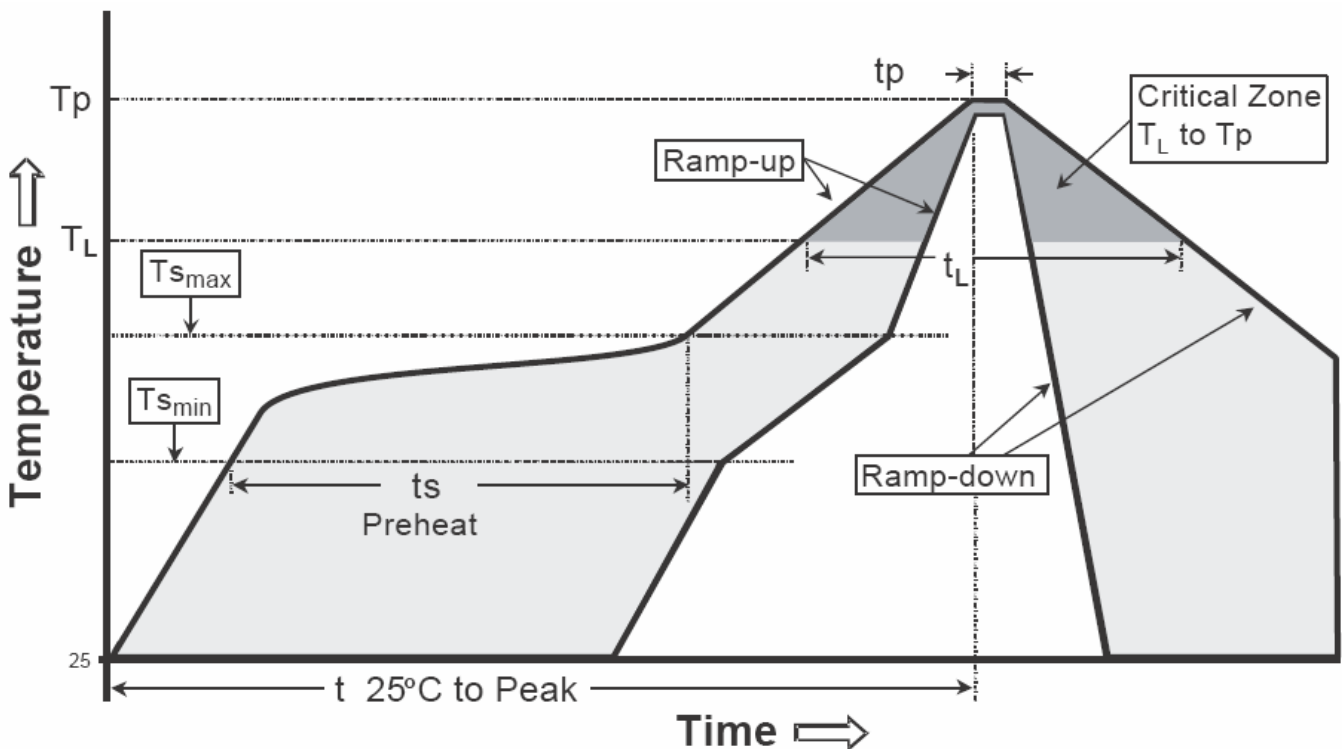
**Carrier Tape Dimension**



**Recommended wave soldering condition**

Product	Peak Temperature	Soldering Time
Pb-free devices	260 +0/-5 °C	5 +1/-1 seconds

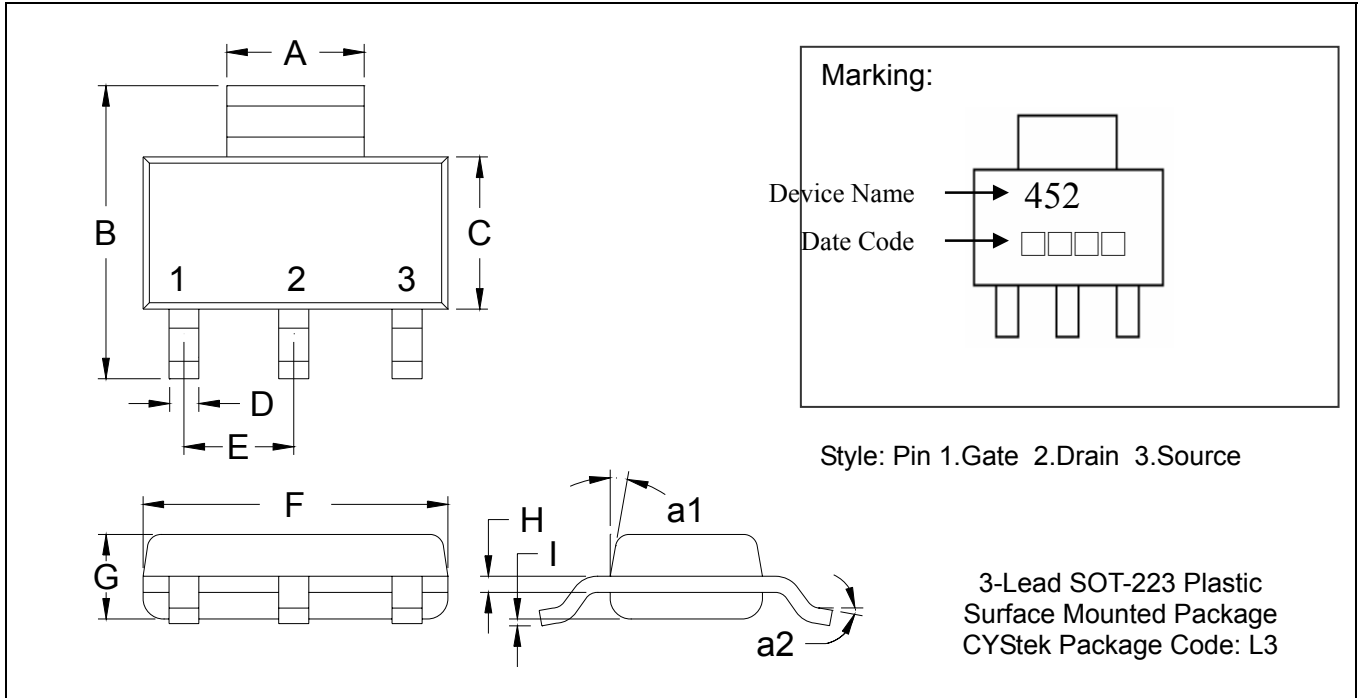
**Recommended temperature profile for IR reflow**



Profile feature	Sn-Pb eutectic Assembly	Pb-free Assembly
Average ramp-up rate (T <sub>smax</sub> to T <sub>p</sub> )	3°C/second max.	3°C/second max.
Preheat		
-Temperature Min(T <sub>s min</sub> )	100°C	150°C
-Temperature Max(T <sub>s max</sub> )	150°C	200°C
-Time(t <sub>s min</sub> to t <sub>s max</sub> )	60-120 seconds	60-180 seconds
Time maintained above:		
-Temperature (T <sub>L</sub> )	183°C	217°C
- Time (t <sub>L</sub> )	60-150 seconds	60-150 seconds
Peak Temperature(T <sub>p</sub> )	240 +0/-5 °C	260 +0/-5 °C
Time within 5°C of actual peak temperature(tp)	10-30 seconds	20-40 seconds
Ramp down rate	6°C/second max.	6°C/second max.
Time 25 °C to peak temperature	6 minutes max.	8 minutes max.

Note : All temperatures refer to topside of the package, measured on the package body surface.

**SOT-223 Dimension**



\*: Typical

DIM	Inches		Millimeters		DIM	Inches		Millimeters	
	Min.	Max.	Min.	Max.		Min.	Max.	Min.	Max.
A	0.1142	0.1220	2.90	3.10	G	0.0551	0.0709	1.40	1.80
B	0.2638	0.2874	6.70	7.30	H	0.0098	0.0138	0.25	0.35
C	0.1299	0.1457	3.30	3.70	I	0.0008	0.0039	0.02	0.10
D	0.0236	0.0315	0.60	0.80	a1	*13°	-	*13°	-
E	*0.0906	-	*2.30	-	a2	0°	10°	0°	10°
F	0.2480	0.2638	6.30	6.70					

Notes: 1.Controlling dimension: millimeters.  
 2.Maximum lead thickness includes lead finish thickness, and minimum lead thickness is the minimum thickness of base material.  
 3.If there is any question with packing specification or packing method, please contact your local CYStek sales office.

**Material:**

- Lead: Pure tin plated
- Mold Compound: Epoxy resin family, flammability solid burning class: UL94V-0

**Important Notice:**

- All rights are reserved. Reproduction in whole or in part is prohibited without the prior written approval of CYStek.
- CYStek reserves the right to make changes to its products without notice.
- CYStek **semiconductor products are not warranted to be suitable for use in Life-Support Applications, or systems.**
- CYStek assumes no liability for any consequence of customer product design, infringement of patents, or application assistance.