

30V P-CHANNEL Enhancement Mode MOSFET

MTP3LP01N3

BV _{DSS}	-30V
I _D	-230mA
R _{DS(on)(typ)}	3 Ω @-4V
	4.6 Ω @-2.5V
	10.9 Ω @-1.5V

Features

- Ultra high speed switching.
- Low gate charge.
- 2.5V drive.
- Pb-free lead plating and halogen-free package.

Equivalent Circuit

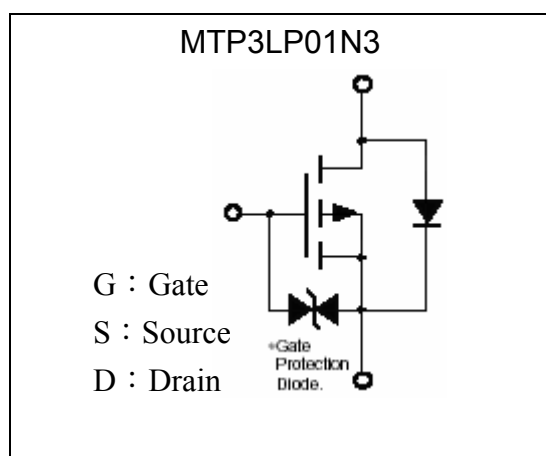

Outline

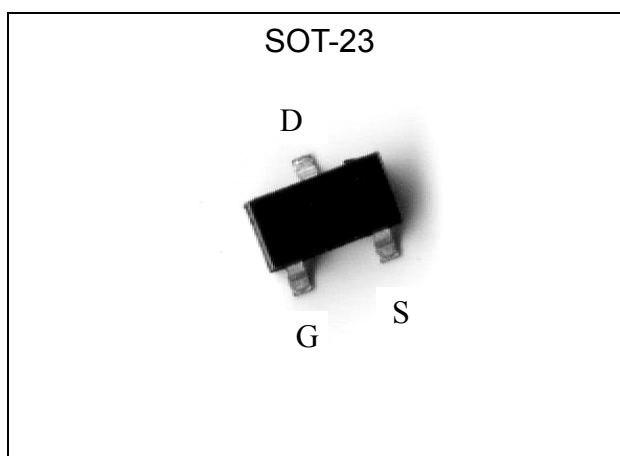

Ordering Information

Device	Package	Shipping
MTP3LP01N3-0-T1-G	SOT-23 (Pb-free lead plating and halogen-free package)	3000 pcs / Tape & Reel

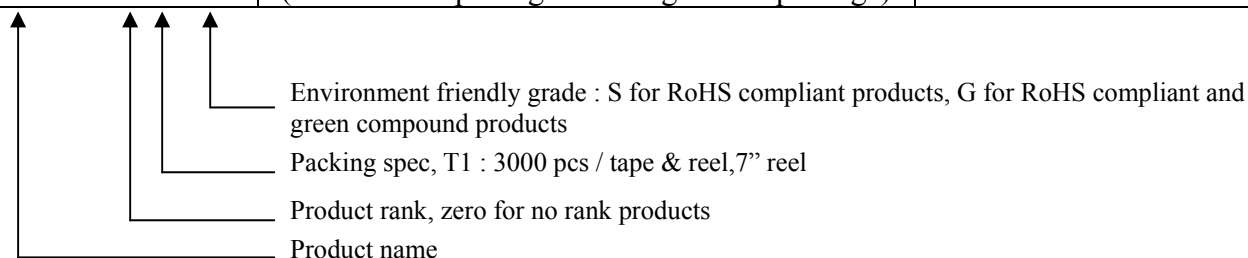



Absolute Maximum Ratings (Ta=25°C, unless otherwise noted)

Parameter	Symbol	Limits	Unit
Drain-Source Voltage	V _{DS}	-30	V
Gate-Source Voltage	V _{GS}	±10	V
Continuous Drain Current	I _D	-230	mA
Pulsed Drain Current (Note 1)	I _{DM}	-920	mA
Maximum Power Dissipation (Note 2)	P _D	250	mW
Thermal Resistance, Junction-to-Ambient	R _{th,ja}	500	°C/W
Operating Junction and Storage Temperature	T _j , T _{stg}	-55~+150	°C

Note : 1. Pulse width ≤ 10μs, duty cycle ≤ 1%.
 2. When mounted on a glass epoxy with a dimension of 100mm²×1mm.

Electrical Characteristics (Ta=25°C, unless otherwise specified)

Symbol	Min.	Typ.	Max.	Unit	Test Conditions
Static					
BV _{DSS}	-30	-	-	V	V _{GS} =0V, I _D =-250μA
V _{GS(th)}	-0.6	0.9	-1.1	V	V _{DS} =-10V, I _D =-100μA
G _{FS}	100	210	-	mS	V _{DS} =-10V, I _D =-100mA
I _{GSS}	-	-	±1	μA	V _{GS} =±8V, V _{DS} =0
I _{DSS}	-	-	-1	μA	V _{DS} =-30V, V _{GS} =0
	-	-	-10		V _{DS} =-24V, V _{GS} =0; T _j =125°C
*R _{DSON}	-	3	5	Ω	V _{GS} =-4V, I _D =-100mA
	-	4.6	8		V _{GS} =-2.5V, I _D =-30mA
	-	10.9	18		V _{GS} =-1.5V, I _D =-1mA
Dynamic					
C _{iss}	-	35.7	-	pF	V _{DS} =-20V, V _{GS} =0, f=1MHz
C _{oss}	-	11.9	-		
C _{rss}	-	3.7	-		
*t _{d(ON)}	-	26.4	-	ns	V _{DS} =-15V, I _D =-100mA, V _{GS} =-4V, R _L =150Ω, R _G =50Ω
*t _r	-	12.8	-		
*t _{d(OFF)}	-	31.5	-		
*t _f	-	46.4	-		
*Q _g	-	0.78	-	nC	V _{DS} =-10V, I _D =-100mA, V _{GS} =-10V
*Q _{gs}	-	0.1	-		
*Q _{gd}	-	0.1	-		
Source-Drain Diode					
*I _S	-	-	-230	mA	
*I _{SM}	-	-	-920		
*V _{SD}	-	0.83	-1.2	V	V _{GS} =0V, I _S =-100mA

*Pulse Test : Pulse Width ≤ 300μs, Duty Cycle ≤ 2%

Typical Characteristics(The minus sign in voltage and current is omitted)

Typical Output Characteristics

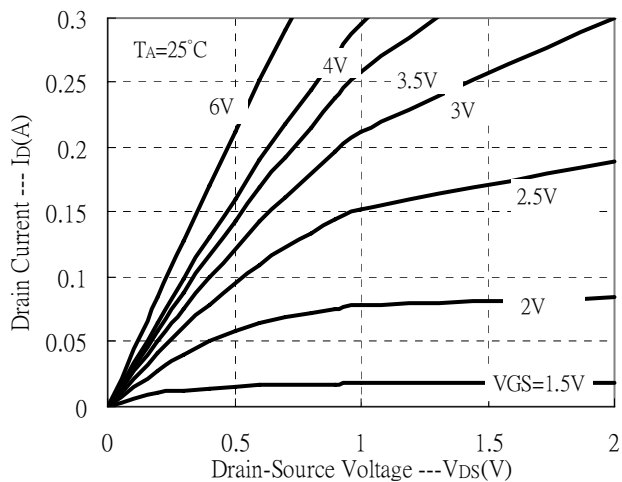

Typical Transfer Characteristics

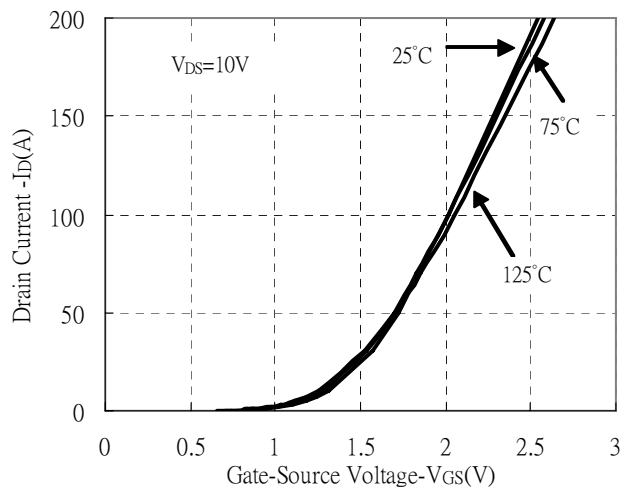

Static Drain-Source On-State Resistance vs Gate-Source Voltage

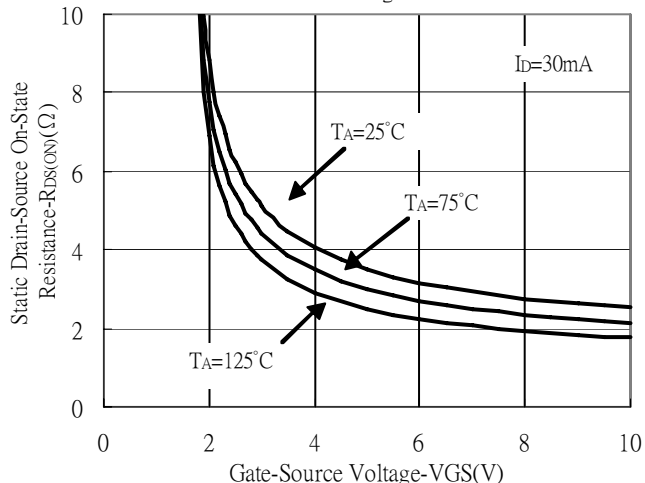

Static Drain-Source On-State Resistance vs Gate-Source Voltage

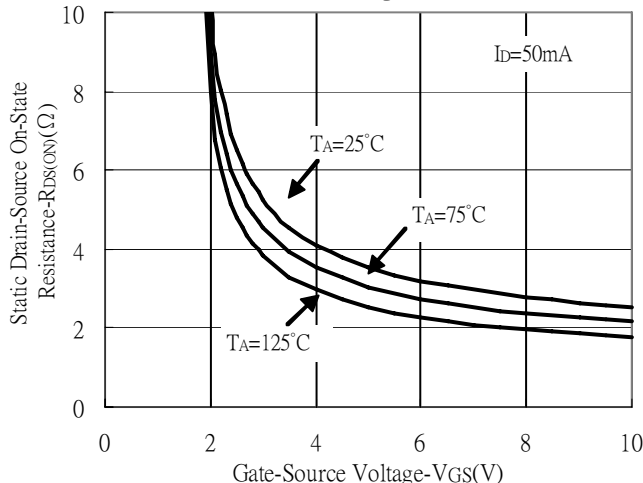

Static Drain-Source On-State resistance vs Drain Current

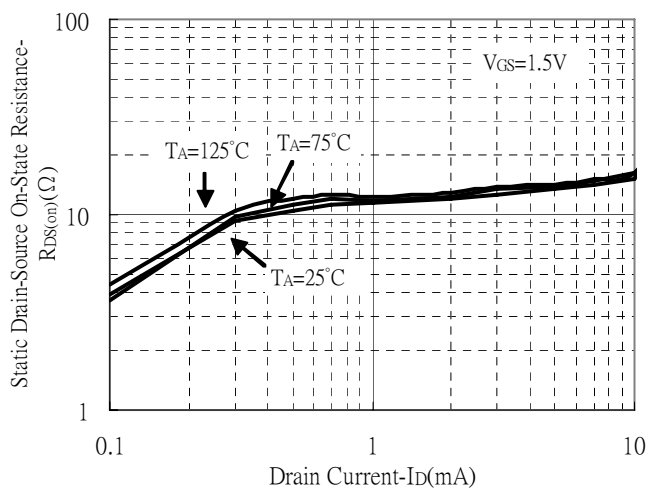

Static Drain-Source On-State resistance vs Drain Current

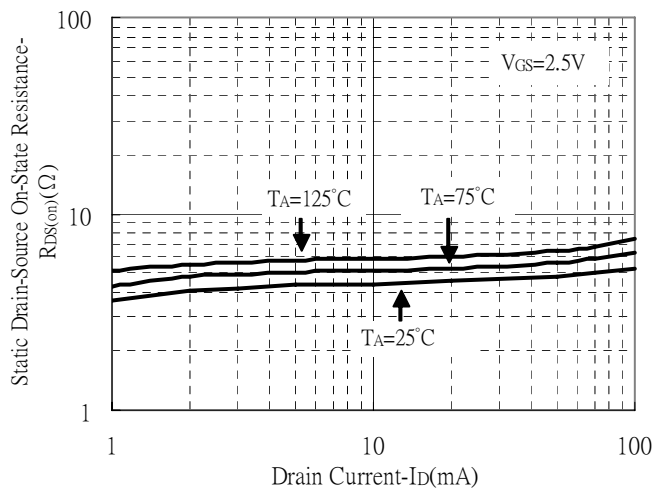

Typical Characteristics(Cont.)

Static Drain-Source On-State resistance vs Drain Current

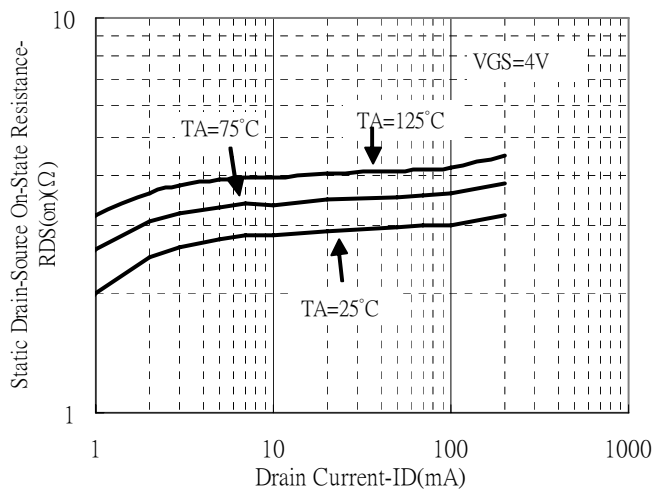

Static Drain-Source On-State resistance vs Ambient Temperature

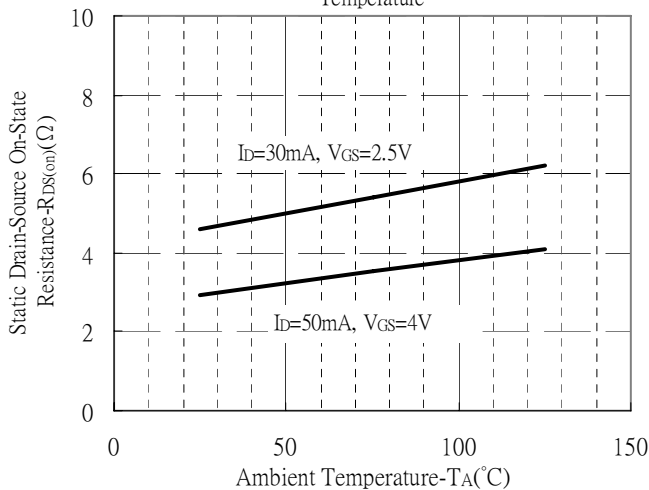

Reverse Drain Current vs Source-Drain Voltage

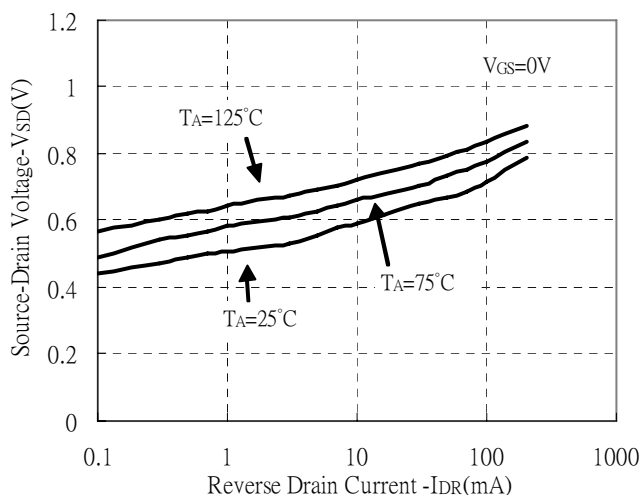

Capacitance vs Drain-to-Source Voltage

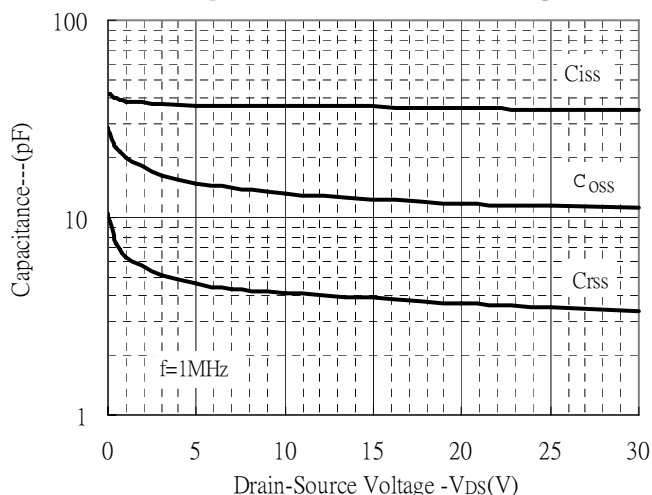

Forward Transfer Admittance vs Drain Current

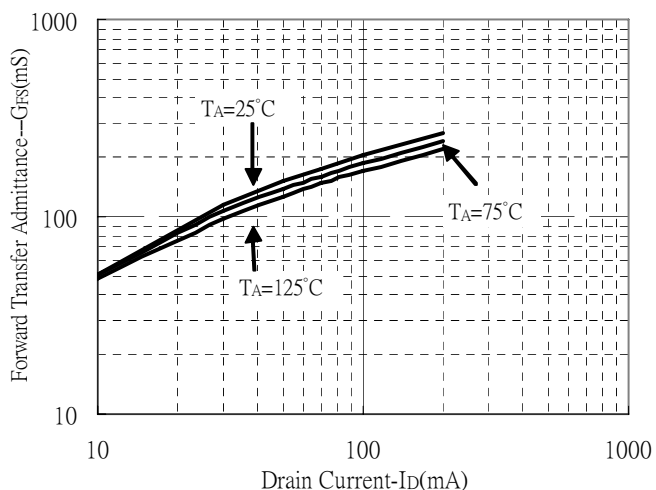

Brekdown Voltage vs Ambient Temperature

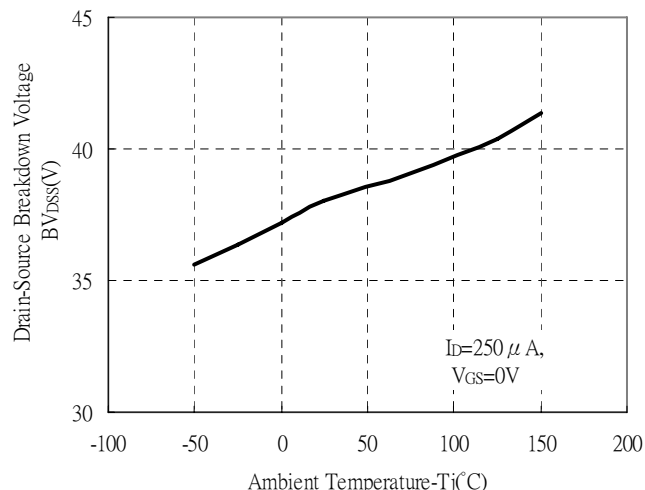

Typical Characteristics(Cont.)

Static Drain-Source On-resistance vs Ambient Temperature

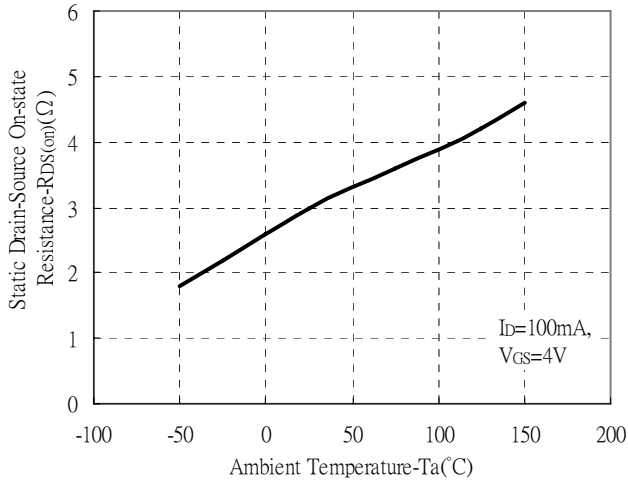

Gate Charge Characteristics

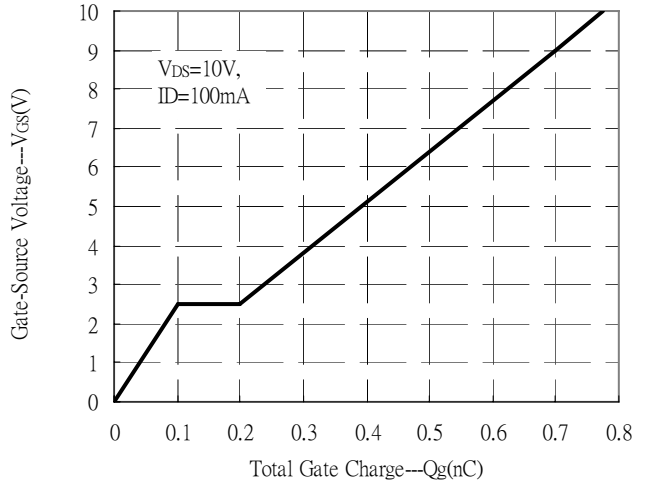

Power Derating Curves

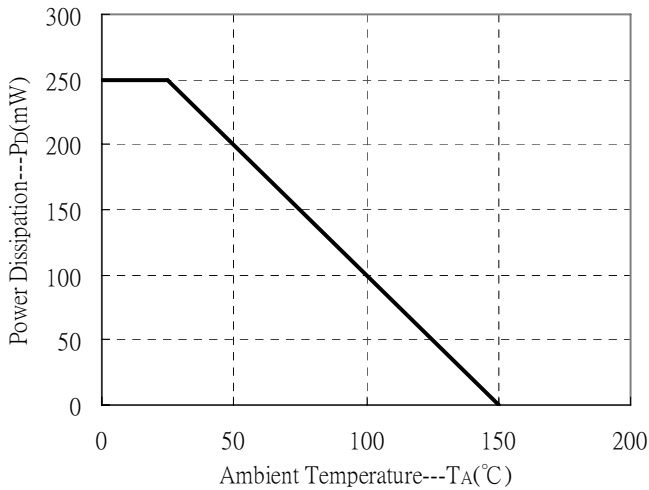

Maximum Safe Operating Area

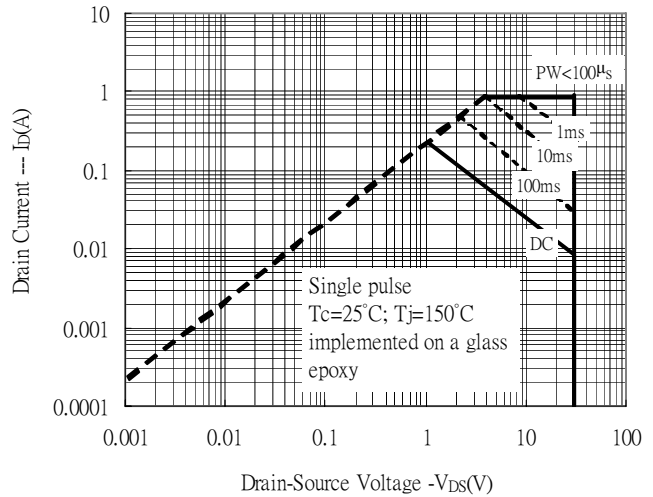

Typical Characteristics(Cont.)

Transient Thermal Response Curves

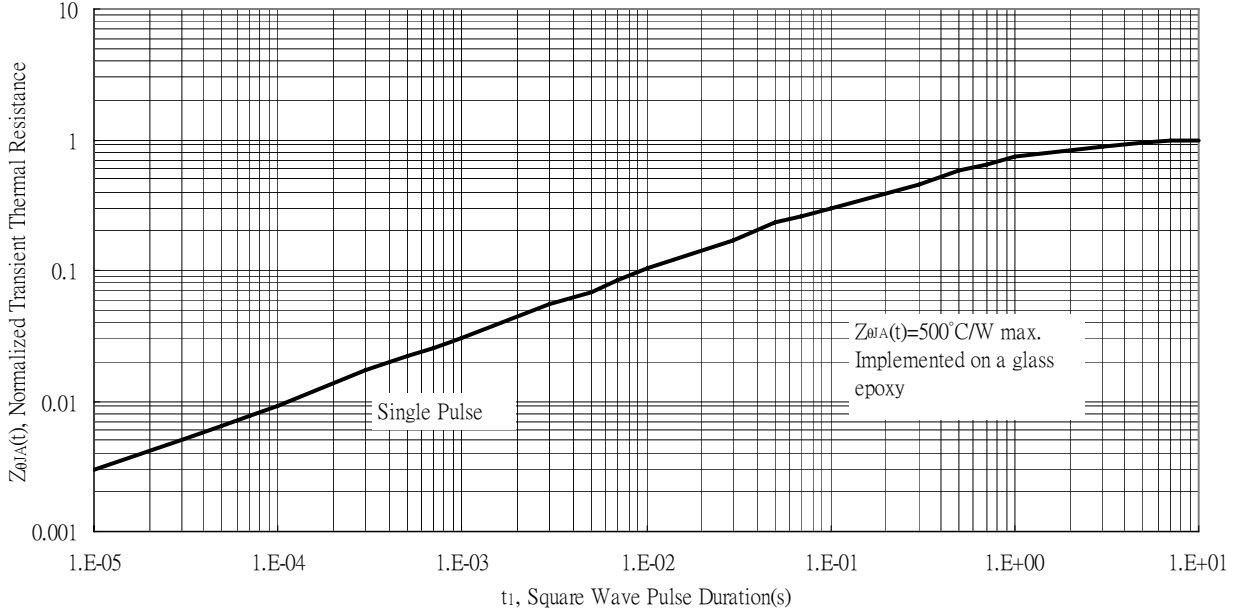

Recommended Soldering Footprint

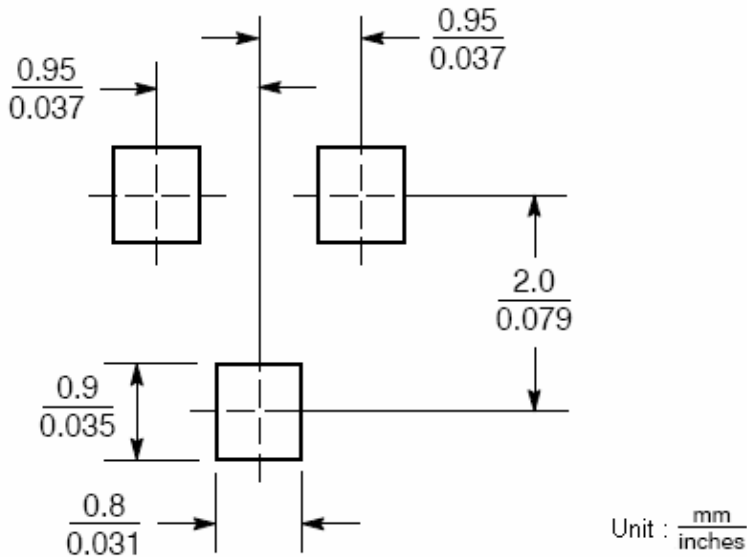

Reel Dimension

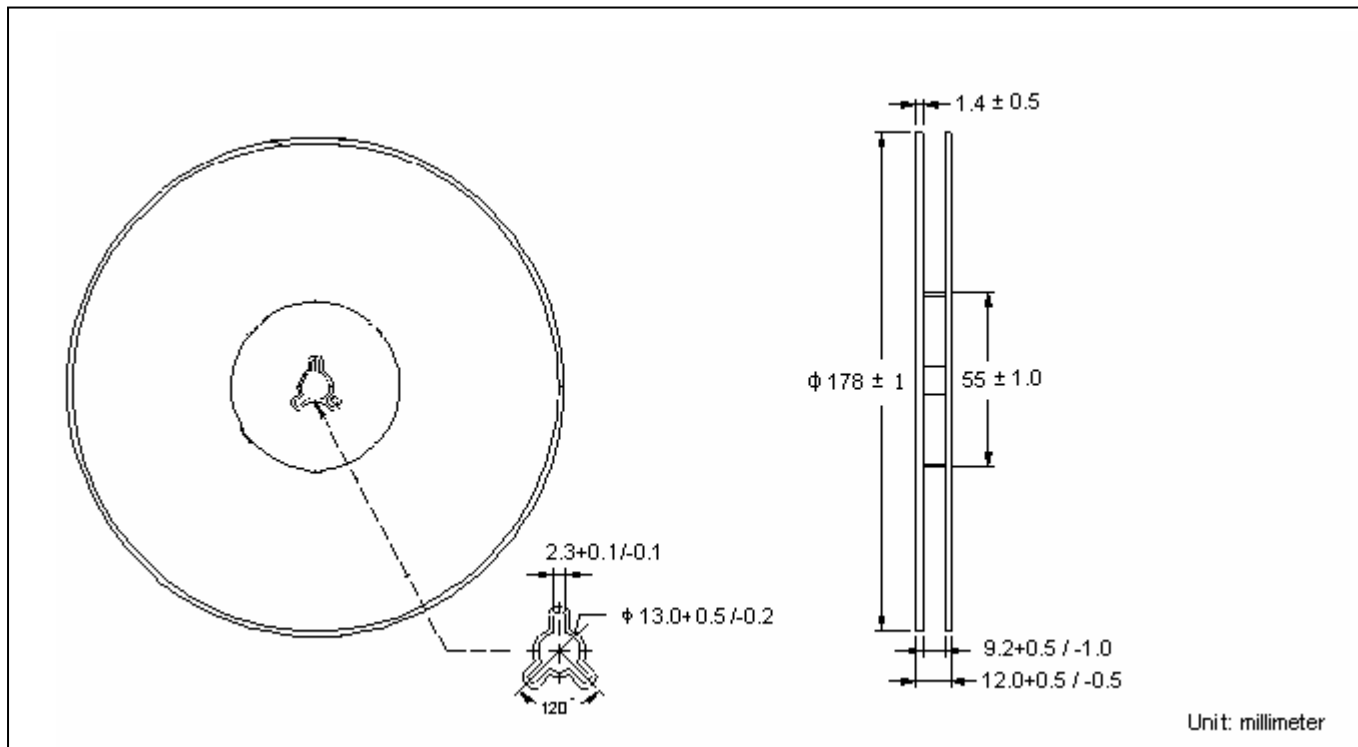

Carrier Tape Dimension

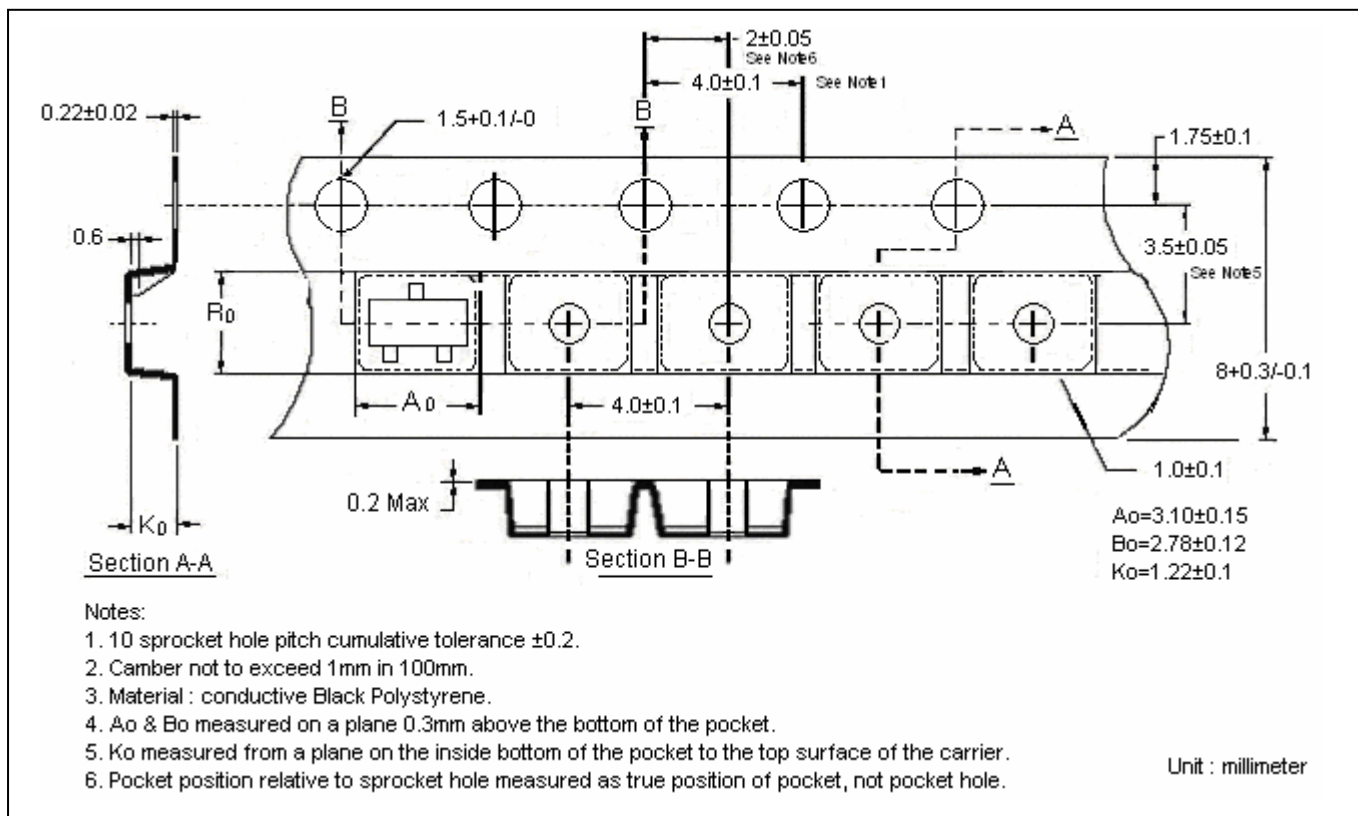

Recommended wave soldering condition

Product	Peak Temperature	Soldering Time
Pb-free devices	260 +0/-5 °C	5 +1/-1 seconds

Recommended temperature profile for IR reflow

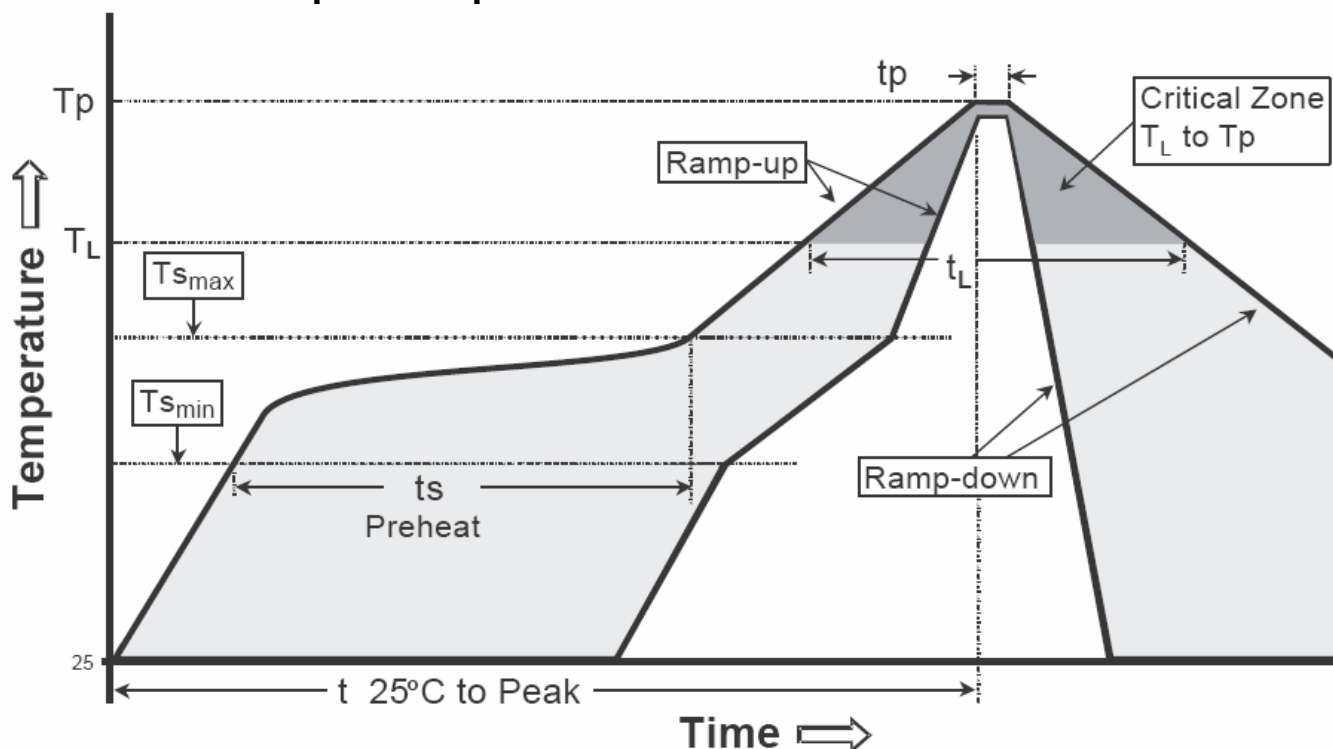

Profile feature	Sn-Pb eutectic Assembly	Pb-free Assembly
Average ramp-up rate (Tsmax to Tp)	3°C/second max.	3°C/second max.
Preheat		
-Temperature Min(Ts min)	100°C	150°C
-Temperature Max(Ts max)	150°C	200°C
-Time(ts min to ts max)	60-120 seconds	60-180 seconds
Time maintained above:		
-Temperature (Tl)	183°C	217°C
- Time (tL)	60-150 seconds	60-150 seconds
Peak Temperature(TP)	240 +0/-5 °C	260 +0/-5 °C
Time within 5°C of actual peak temperature(tp)	10-30 seconds	20-40 seconds
Ramp down rate	6°C/second max.	6°C/second max.
Time 25 °C to peak temperature	6 minutes max.	8 minutes max.

Note : All temperatures refer to topside of the package, measured on the package body surface.

SOT-23 Dimension

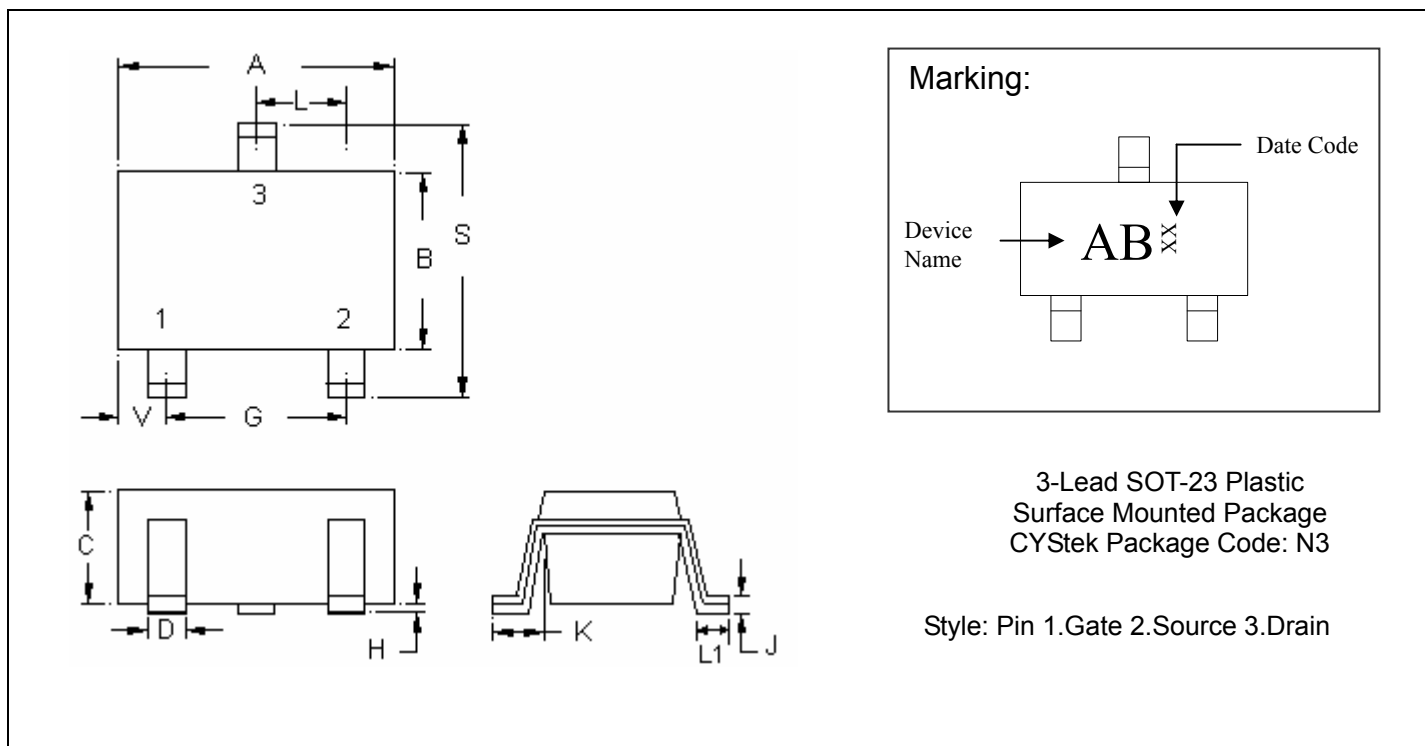

*: Typical

DIM	Inches		Millimeters		DIM	Inches		Millimeters	
	Min.	Max.	Min.	Max.		Min.	Max.	Min.	Max.
A	0.1102	0.1204	2.80	3.04	J	0.0032	0.0079	0.08	0.20
B	0.0472	0.0669	1.20	1.70	K	0.0118	0.0266	0.30	0.67
C	0.0335	0.0512	0.89	1.30	L	0.0335	0.0453	0.85	1.15
D	0.0118	0.0197	0.30	0.50	S	0.0830	0.1161	2.10	2.95
G	0.0669	0.0910	1.70	2.30	V	0.0098	0.0256	0.25	0.65
H	0.0000	0.0040	0.00	0.10	L1	0.0118	0.0197	0.30	0.50

Notes: 1.Controlling dimension: millimeters.
 2.Maximum lead thickness includes lead finish thickness, and minimum lead thickness is the minimum thickness of base material.
 3.If there is any question with packing specification or packing method, please contact your local CYStek sales office.

Material:

- Lead: Pure tin plated.
- Mold Compound: Epoxy resin family, flammability solid burning class: UL94V-0.

Important Notice:

- All rights are reserved. Reproduction in whole or in part is prohibited without the prior written approval of CYStek.
- CYStek reserves the right to make changes to its products without notice.
- CYStek **semiconductor products are not warranted to be suitable for use in Life-Support Applications, or systems.**
- CYStek assumes no liability for any consequence of customer product design, infringement of patents, or application assistance.