

**N-CHANNEL MOSFET (dual transistors)**

# MTDN1034C6

**Features**

- High speed switching
- Low-voltage drive(1.5V)
- Easily designed drive circuits
- Easy to use in parallel
- Pb-free package

$BV_{DSS}$		30V
$I_D$		0.3A
$R_{DS(on)(TYP)}$	$V_{GS}=4.5V, I_D=200mA$	0.85 $\Omega$
	$V_{GS}=2.5V, I_D=175mA$	1.23 $\Omega$
	$V_{GS}=1.8V, I_D=150mA$	1.8 $\Omega$
	$V_{GS}=1.5V, I_D=40mA$	2.3 $\Omega$

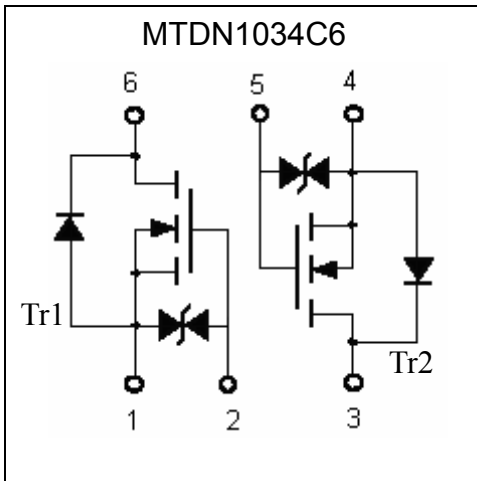
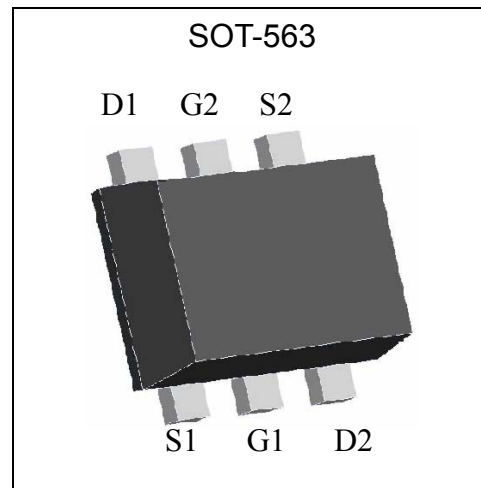
**Equivalent Circuit**

**Outline**

The following characteristics apply to both Tr1 and Tr2

**Absolute Maximum Ratings** ( $T_a=25^{\circ}C$ , unless otherwise specified)

Parameter	Symbol	Limits	Unit
Drain-Source Voltage	$V_{DSS}$	30	V
Gate-Source Voltage	$V_{GSS}$	$\pm 8$	V
Continuous Drain Current @ $V_{GS}=4.5V, T_A=25^{\circ}C$	$I_D$	0.3	A
Continuous Drain Current @ $V_{GS}=4.5V, T_A=85^{\circ}C$		0.22	
Pulsed Drain Current	$I_{DM}$	1.6 (Note 1)	
Power Dissipation	$P_d$	150 (Note 2)	mW
Operating Junction Temperature Range	$T_j$	-55~+150	$^{\circ}C$
Storage Temperature Range	$T_{stg}$	-55~+150	$^{\circ}C$

- Note : 1. Pulse test, pulse width $\leq 300\mu s$ , duty $\leq 2\%$   
 2. 120mW per element must not be exceeded.



**Electrical Characteristics** (Ta=25°C, unless otherwise specified)

Symbol	Min.	Typ.	Max.	Unit	Test Conditions
<b>Static</b>					
BV <sub>DSS</sub> *	30	-	-	V	V <sub>GS</sub> =0, I <sub>D</sub> =10μA
V <sub>GS(th)</sub>	0.5	0.78	1.1	V	V <sub>DS</sub> =V <sub>GS</sub> , I <sub>D</sub> =250μA
I <sub>GSS</sub>	-	-	±1	μA	V <sub>GS</sub> =±8V, V <sub>DS</sub> =0
I <sub>DSS</sub>	-	-	100	nA	V <sub>DS</sub> =30V, V <sub>GS</sub> =0
R <sub>DS(ON)</sub> *	-	0.85	1.5	Ω	V <sub>GS</sub> =4.5V, I <sub>D</sub> =200mA
	-	1.23	3		V <sub>GS</sub> =2.5V, I <sub>D</sub> =175mA
	-	1.8	4		V <sub>GS</sub> =1.8V, I <sub>D</sub> =150mA
	-	2.3	5		V <sub>GS</sub> =1.5V, I <sub>D</sub> =40mA
G <sub>FS</sub>	-	460	-	mS	V <sub>DS</sub> =10V, I <sub>D</sub> =200mA
<b>Dynamic</b>					
C <sub>iss</sub>	-	33.5	-	pF	V <sub>DS</sub> =15V, V <sub>GS</sub> =0, f=1MHz
C <sub>oss</sub>	-	6.1	-		
C <sub>rss</sub>	-	2.5	-		
Q <sub>g</sub>	-	495	-	pC	V <sub>DS</sub> =15V, I <sub>D</sub> =300mA, V <sub>GS</sub> =4.5V
Q <sub>gs</sub>	-	49	-		
Q <sub>gd</sub>	-	175	-		
t <sub>d(on)</sub>	-	-	50	ns	V <sub>DD</sub> =15V, I <sub>D</sub> =200mA, V <sub>GS</sub> =4.5V, R <sub>G</sub> =10Ω
t <sub>r</sub>	-	-	25		
t <sub>d(off)</sub>	-	-	50		
t <sub>f</sub>	-	-	25		
<b>Source-Drain Diode</b>					
I <sub>S</sub>	-	-	0.3	A	
I <sub>SM</sub>	-	-	2		
V <sub>SD</sub>	-	0.81	1	V	I <sub>S</sub> =150mA, V <sub>GS</sub> =0V

\*Pulse Test : Pulse Width ≤300μs, Duty Cycle ≤2%

**Ordering Information**

Device	Package	Shipping	Marking
MTDN1034C6	SOT-563 (Pb-free and halogen-free package)	3000 pcs / Tape & Reel	KL

## Typical Characteristics

Typical Output Characteristics

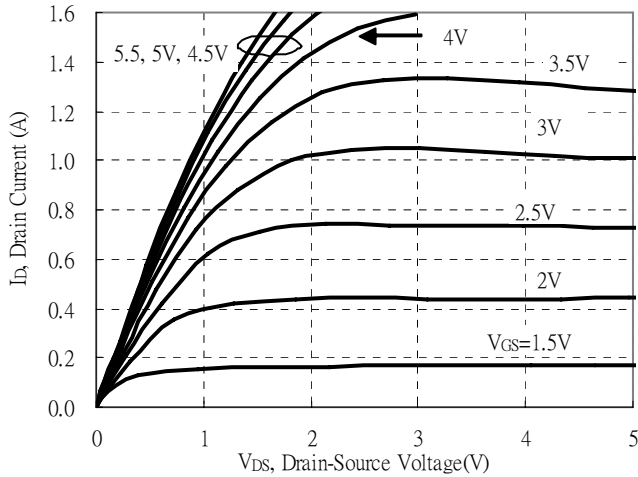

Breakdown Voltage vs Ambient Temperature

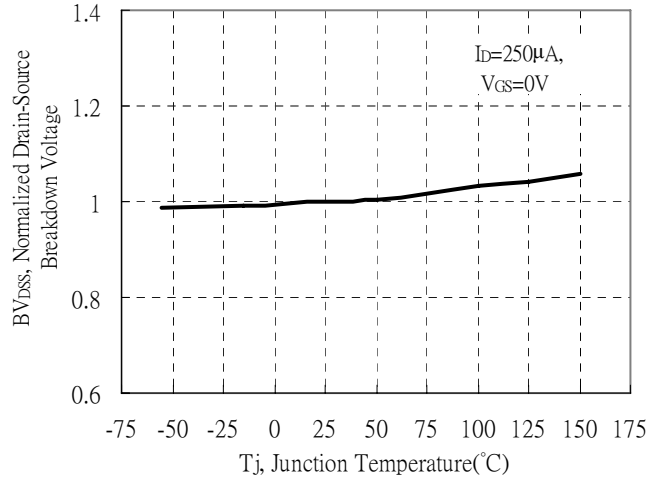

Static Drain-Source On-State resistance vs Drain Current

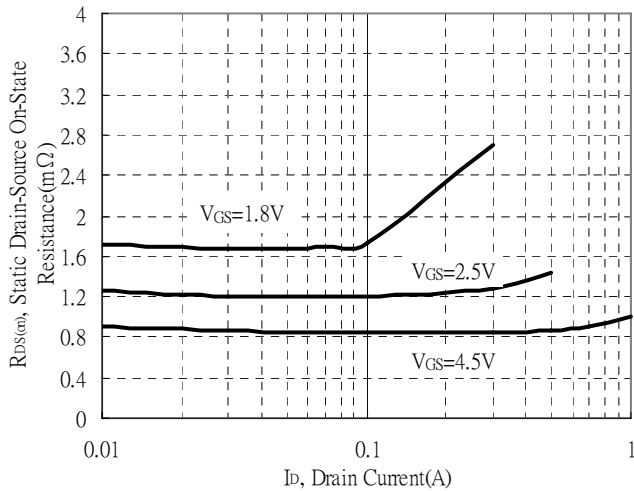

Reverse Drain Current vs Source-Drain Voltage

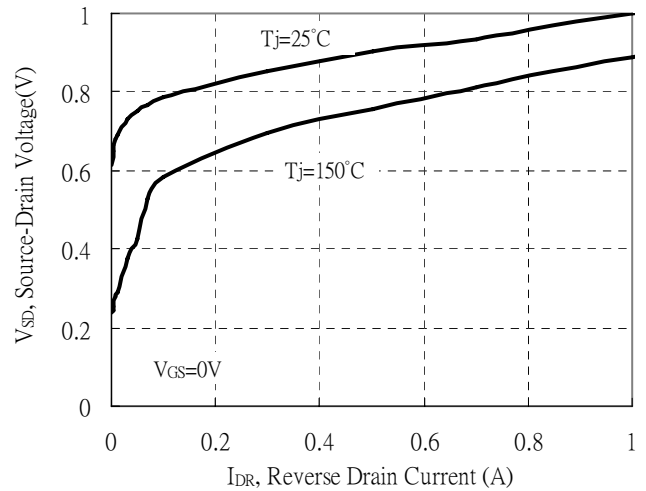

Static Drain-Source On-State Resistance vs Gate-Source Voltage

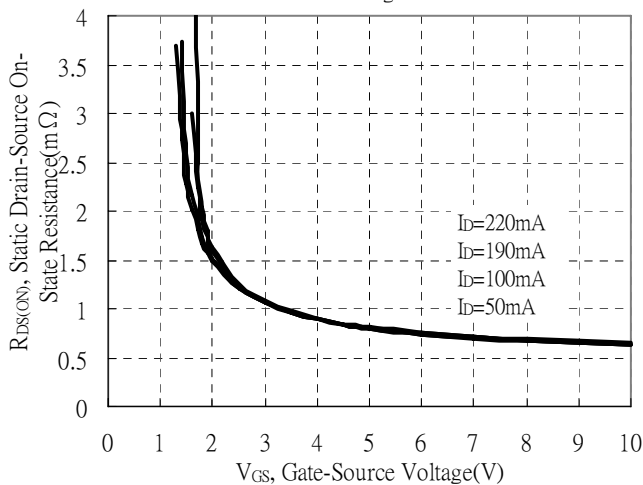

Drain-Source On-State Resistance vs Junction Temperature

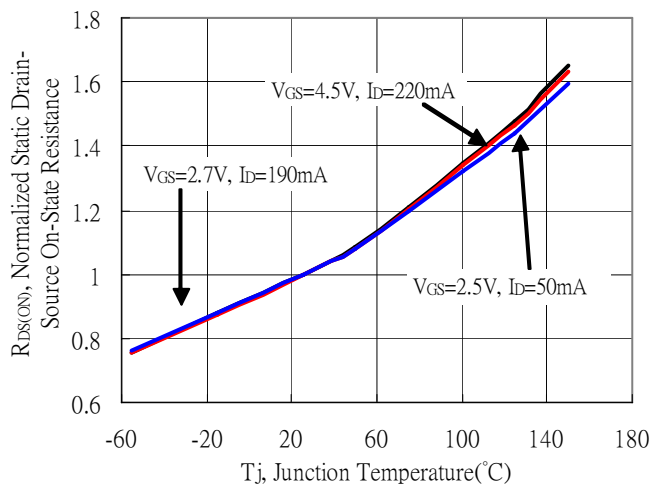

## Typical Characteristics(Cont.)

Capacitance vs Drain-to-Source Voltage

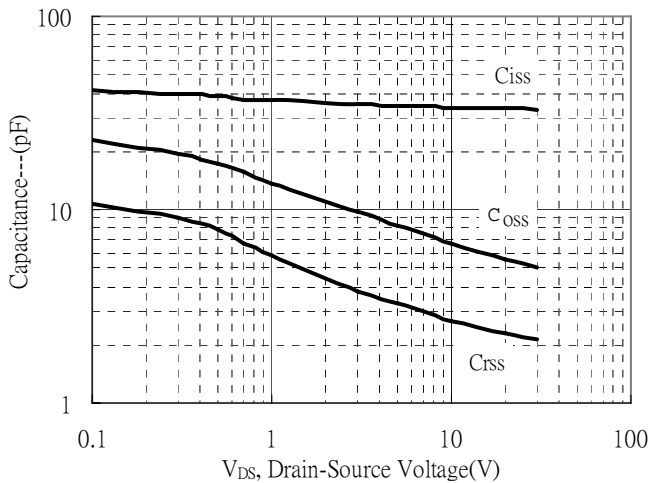

Threshold Voltage vs Junction Temperature

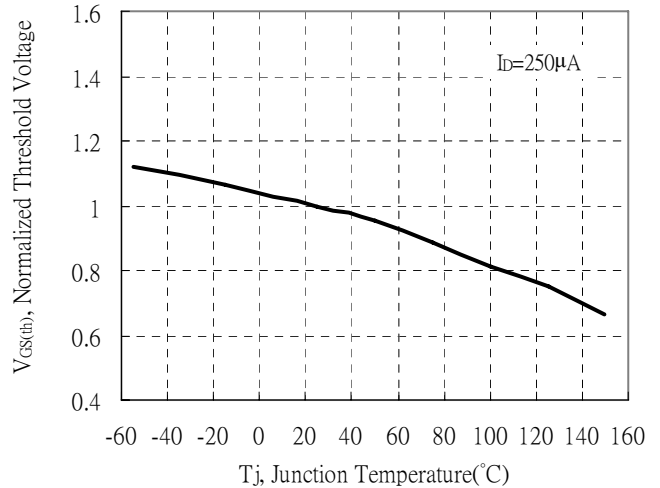

Single Pulse Power Rating, Junction to Ambient  
 (Note on page 2)

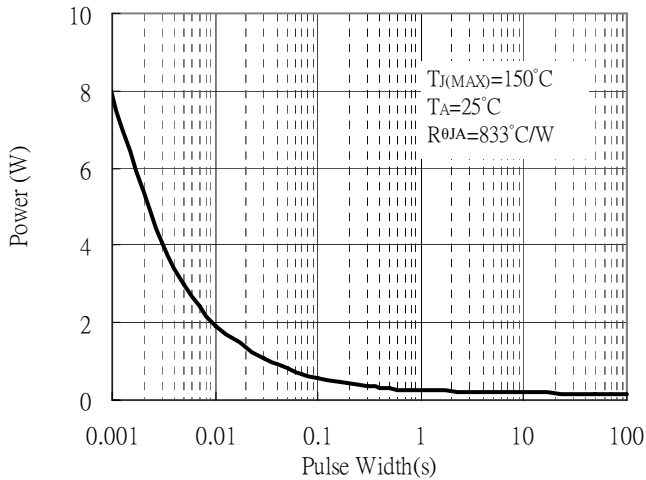

Gate Charge Characteristics

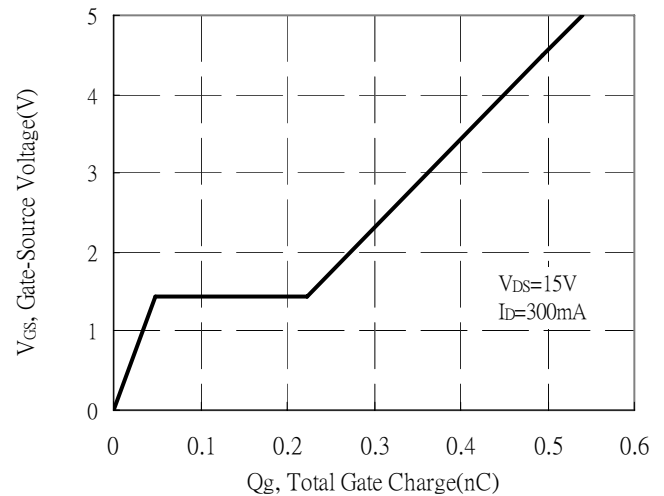

Maximum Safe Operating Area

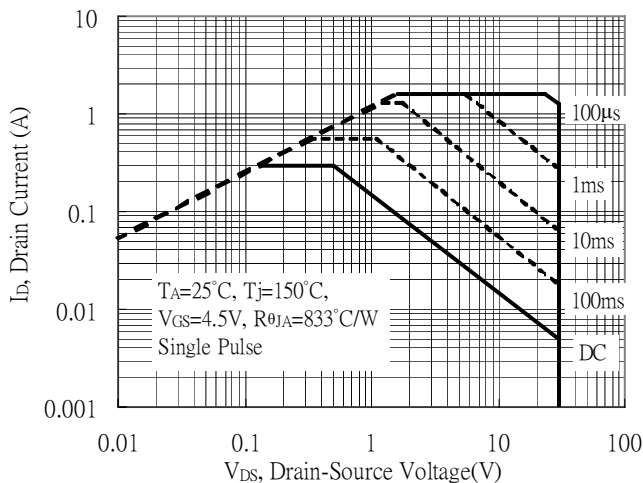

Maximum Drain Current vs Junction Temperature

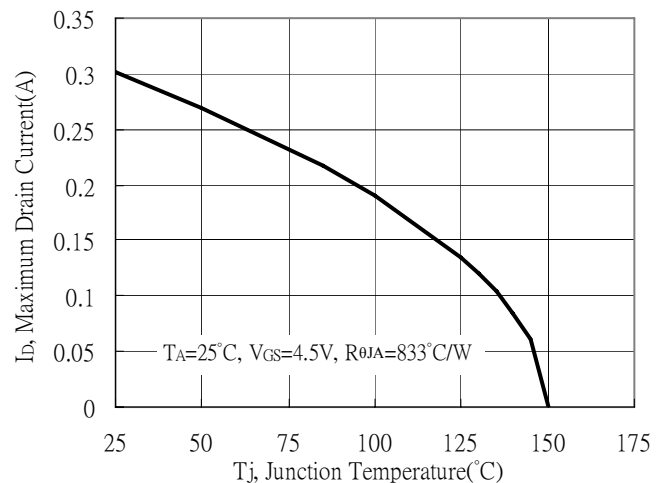

**Typical Characteristics(Cont.)**

Typical Transfer Characteristics

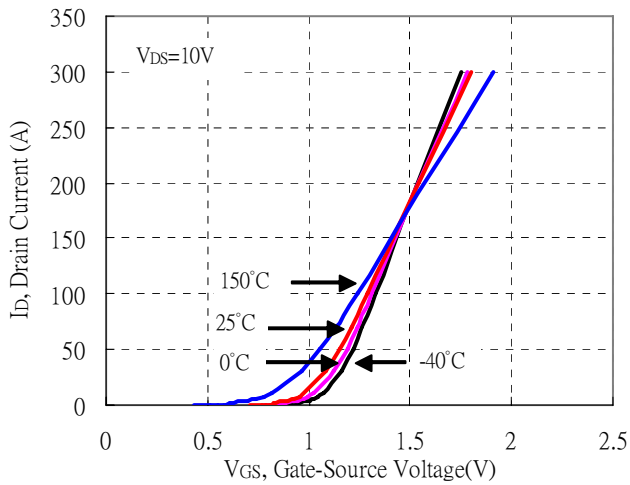

Forward Transfer Admittance vs Drain Current

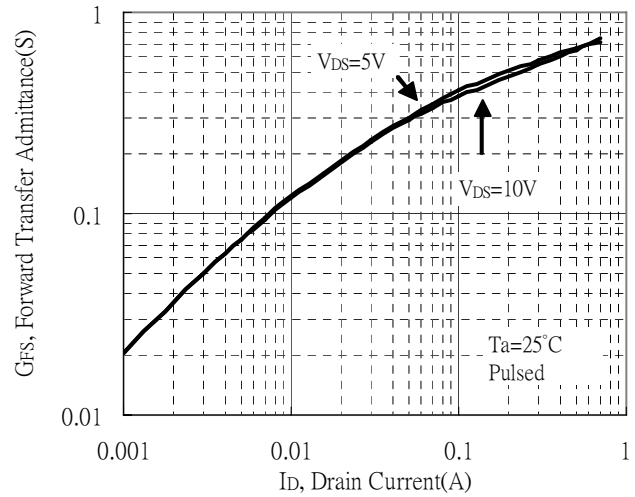

Transient Thermal Response Curves

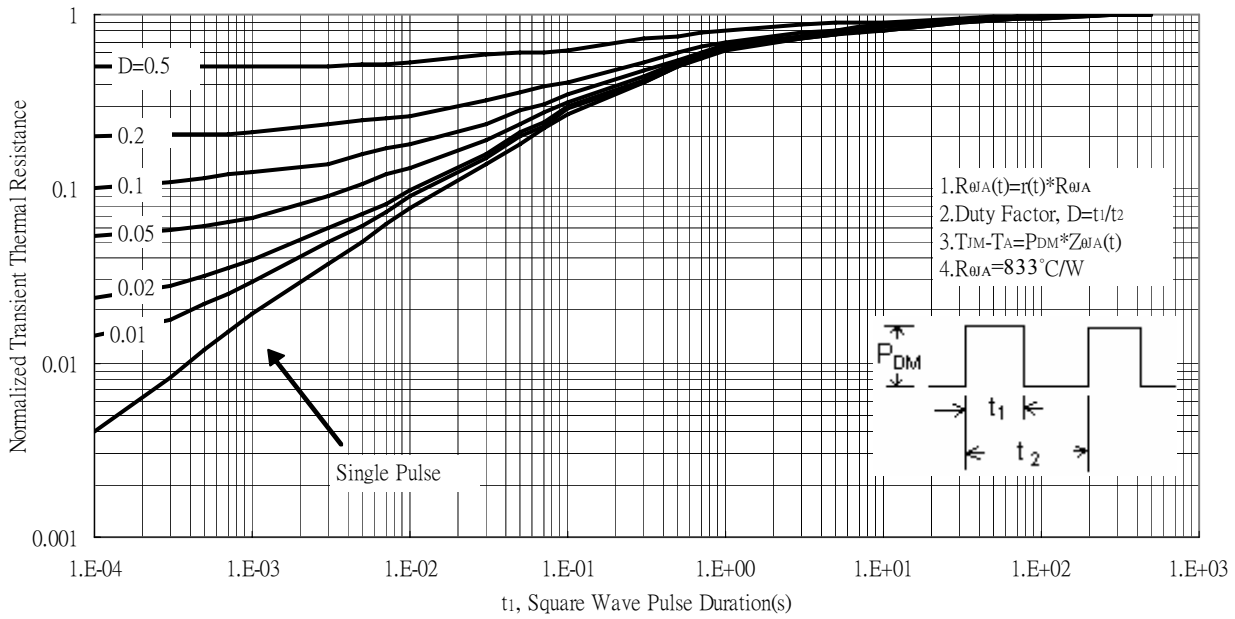

**Reel Dimension**

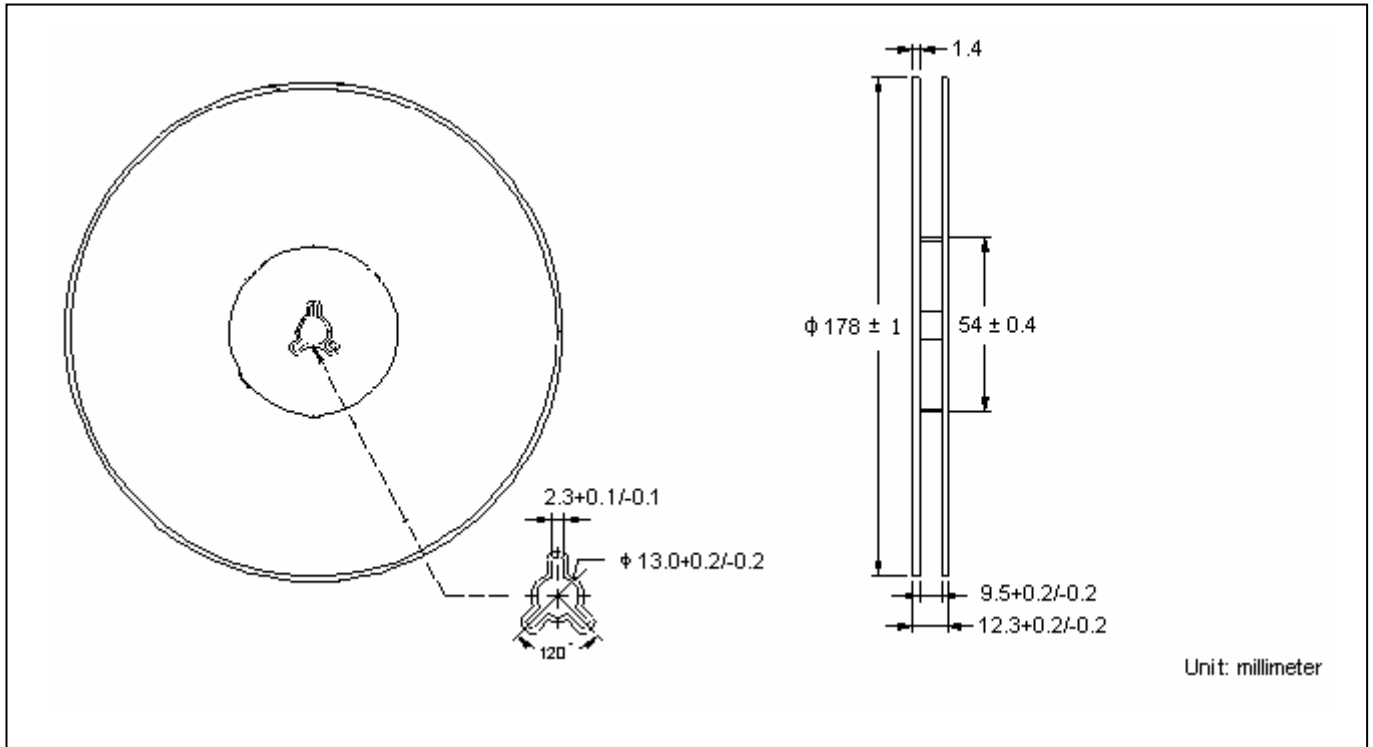

**Carrier Tape Dimension**

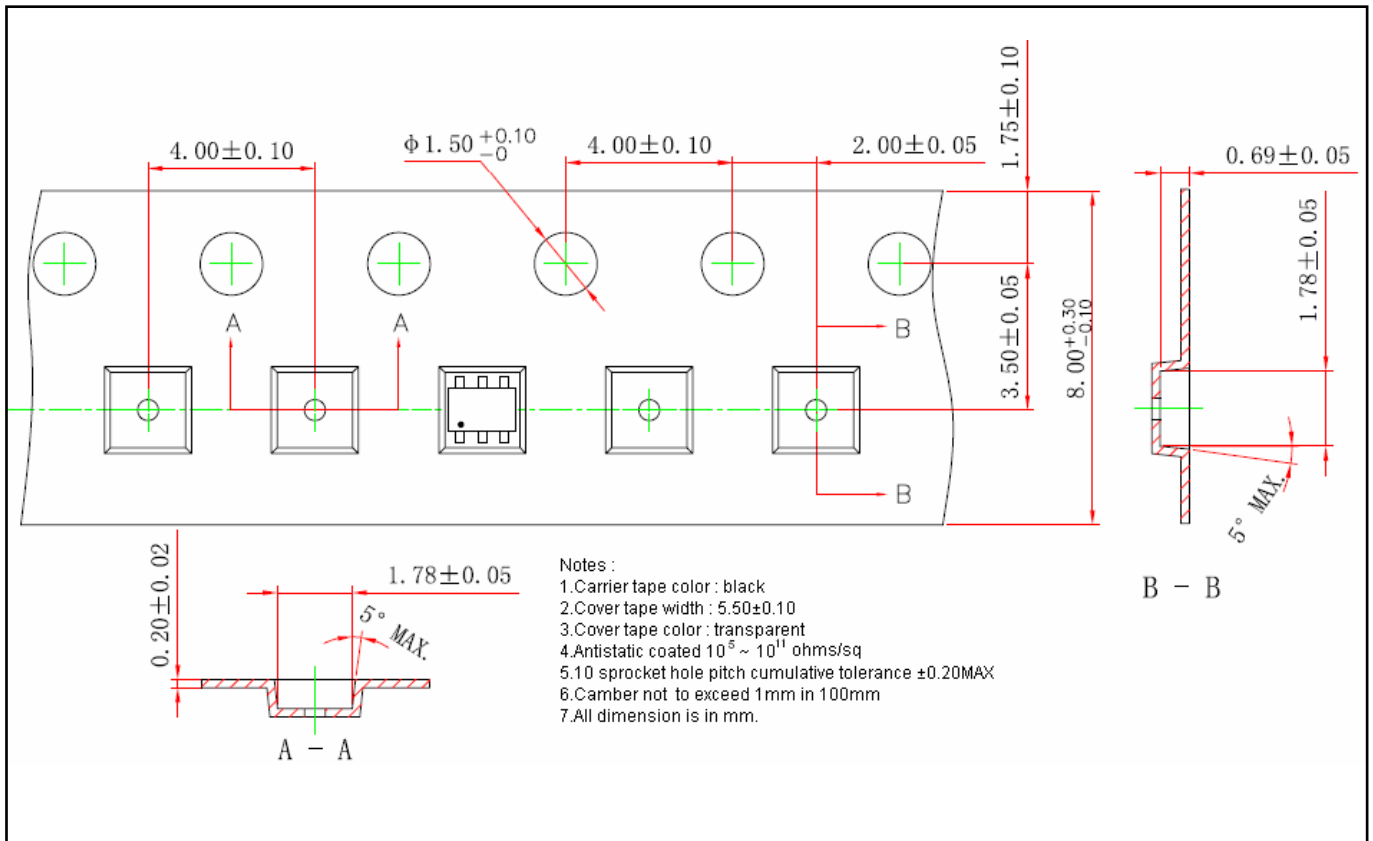

**Recommended wave soldering condition**

Product	Peak Temperature	Soldering Time
Pb-free devices	260 +0/-5 °C	5 +1/-1 seconds

**Recommended temperature profile for IR reflow**

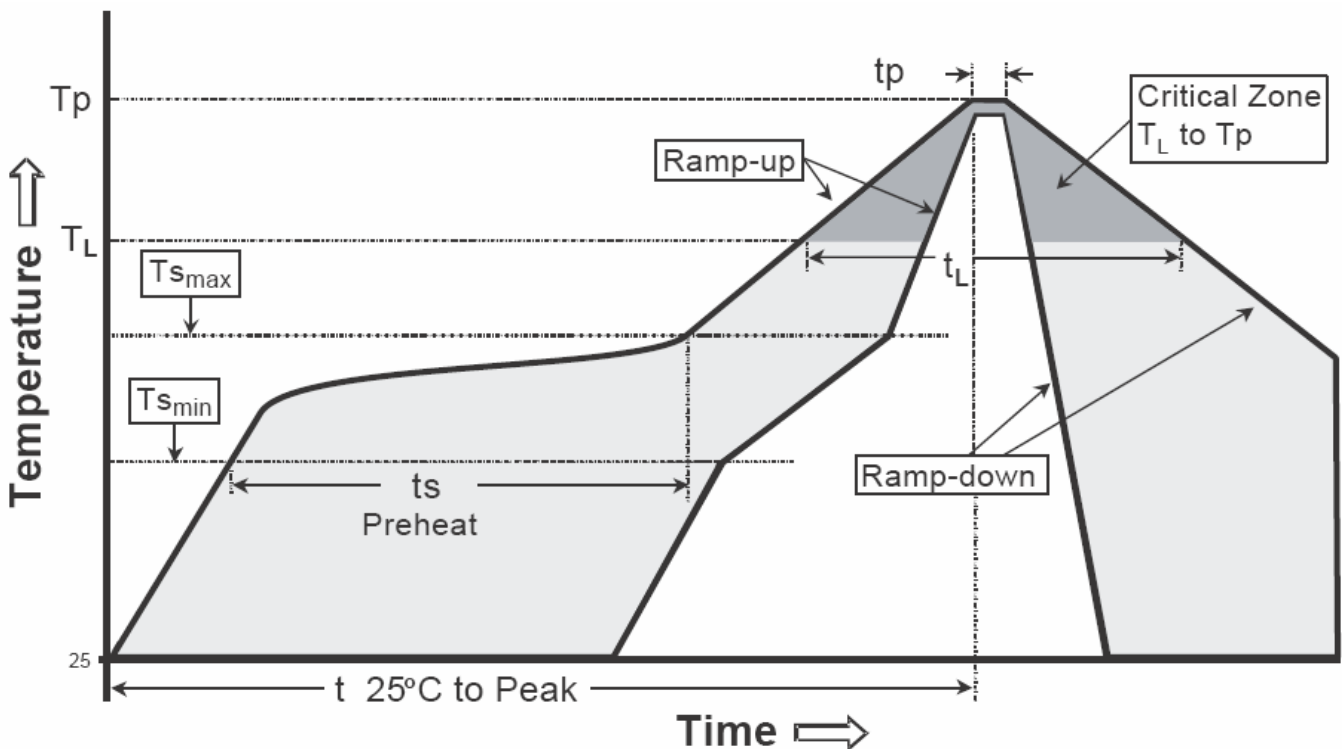

Profile feature	Sn-Pb eutectic Assembly	Pb-free Assembly
Average ramp-up rate (T <sub>smax</sub> to T <sub>p</sub> )	3°C/second max.	3°C/second max.
Preheat		
-Temperature Min(T <sub>s min</sub> )	100°C	150°C
-Temperature Max(T <sub>s max</sub> )	150°C	200°C
-Time(t <sub>s min</sub> to t <sub>s max</sub> )	60-120 seconds	60-180 seconds
Time maintained above:		
-Temperature (T <sub>L</sub> )	183°C	217°C
- Time (t <sub>L</sub> )	60-150 seconds	60-150 seconds
Peak Temperature(T <sub>P</sub> )	240 +0/-5 °C	260 +0/-5 °C
Time within 5°C of actual peak temperature(tp)	10-30 seconds	20-40 seconds
Ramp down rate	6°C/second max.	6°C/second max.
Time 25 °C to peak temperature	6 minutes max.	8 minutes max.

Note : All temperatures refer to topside of the package, measured on the package body surface.

**SOT-563 Dimension**

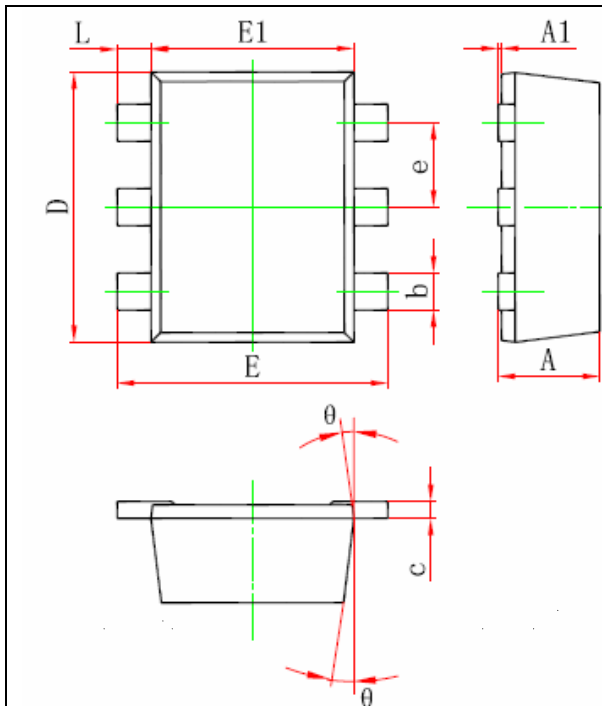

**Marking:**

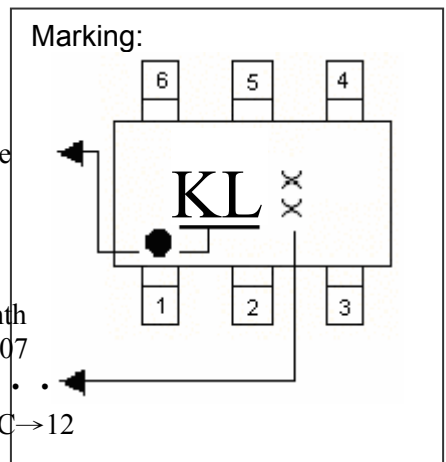

Product Code

Date Code: Year+Month  
 Year: 6→2006, 7→2007  
 Month: 1→1, 2→2, . . .  
 9→9, A→10, B→11, C→12

Style:  
 Pin 1. Source1 (S1)  
 Pin 2. Gate1 (G1)  
 Pin 3. Drain2 (D2)  
 Pin 4. Source2 (S2)  
 Pin 5. Gate2 (G2)  
 Pin 6. Drain1 (D1)

6-Lead SOT-563 Plastic Surface Mounted Package  
 CYStek Package Code: C6

DIM	Inches		Millimeters		DIM	Inches		Millimeters	
	Min.	Max.	Min.	Max.		Min.	Max.	Min.	Max.
A	0.021	0.024	0.525	0.600	b	0.007	0.011	0.170	0.270
A1	0.000	0.002	0.000	0.050	E1	0.043	0.051	1.100	1.300
e	0.018	0.022	0.450	0.550	E	0.059	0.067	1.500	1.700
c	0.004	0.006	0.090	0.160	L	0.004	0.012	0.100	0.300
D	0.059	0.067	1.500	1.700	θ	7° REF		7° REF	

**Notes :** 1.Controlling dimension : millimeters.  
 2.Maximum lead thickness includes lead finish thickness, and minimum lead thickness is the minimum thickness of base material.  
 3.If there is any question with packing specification or packing method, please contact your local CYStek sales office.

**Material :**

- Lead : Pure tin plated.
- Mold Compound : Epoxy resin family, flammability solid burning class:UL94V-0.

**Important Notice:**

- All rights are reserved. Reproduction in whole or in part is prohibited without the prior written approval of CYStek.
- CYStek reserves the right to make changes to its products without notice.
- CYStek **semiconductor products are not warranted to be suitable for use in Life-Support Applications, or systems.**
- CYStek assumes no liability for any consequence of customer product design, infringement of patents, or application assistance.