

30V P-CHANNEL Enhancement Mode MOSFET

MTP3LP01Y3

BV_{DSS}	-30V
I_D	-230mA
$R_{DS(on)(typ)}$	$3\ \Omega @ -4V$
	$4.6\ \Omega @ -2.5V$
	$10.9\ \Omega @ -1.5V$

Features

- Ultra high speed switching.
- Low gate charge.
- 2.5V drive.
- Pb-free package lead plating and halogen-free package.

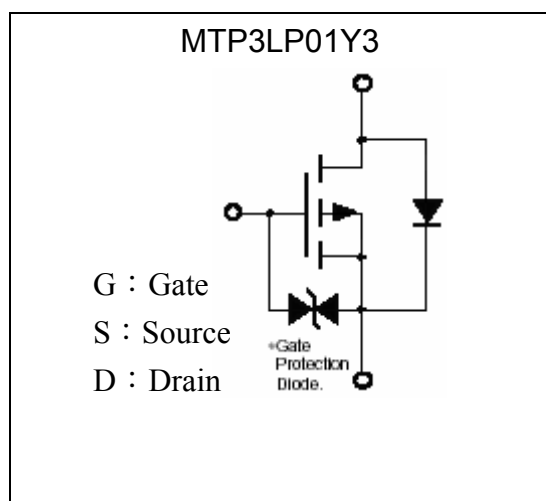
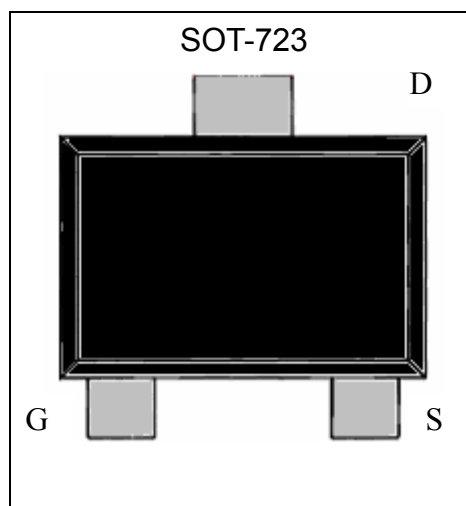
Equivalent Circuit

Outline

Absolute Maximum Ratings (Ta=25°C, unless otherwise noted)

Parameter	Symbol	Limits	Unit
Drain-Source Voltage	V_{DS}	-30	V
Gate-Source Voltage	V_{GS}	±10	V
Continuous Drain Current	I_D	-230	mA
Pulsed Drain Current (Note 1)	I_{DM}	-920	mA
Maximum Power Dissipation (Note 2)	P_D	150	mW
Thermal Resistance, Junction-to-Ambient	$R_{th,ja}$	833	°C/W
Operating Junction and Storage Temperature	T_j, T_{stg}	-55~+150	°C

Note : 1. Pulse width ≤ 10μs, duty cycle ≤ 1%.
 2. When mounted on a glass epoxy with a dimension of 100mm²×1mm.



Electrical Characteristics (Ta=25°C, unless otherwise specified)

Symbol	Min.	Typ.	Max.	Unit	Test Conditions
Static					
BV _{DSS}	-30	-	-	V	V _{GS} =0V, I _D =-250μA
V _{GS(th)}	-0.6	0.9	-1.1	V	V _{DS} =-10V, I _D =-100μA
G _{FS}	100	210	-	mS	V _{DS} =-10V, I _D =-100mA
I _{GSS}	-	-	±1	μA	V _{GS} =±8V, V _{DS} =0
I _{DSS}	-	-	-1	μA	V _{DS} =-30V, V _{GS} =0
	-	-	-10		V _{DS} =-24V, V _{GS} =0; T _j =125°C
*R _{DS(ON)}	-	3	5	Ω	V _{GS} =-4V, I _D =-100mA
	-	4.6	8		V _{GS} =-2.5V, I _D =-30mA
	-	10.9	18		V _{GS} =-1.5V, I _D =-1mA
Dynamic					
C _{iss}	-	35.7	-	pF	V _{DS} =-20V, V _{GS} =0, f=1MHz
C _{oss}	-	11.9	-		
C _{rss}	-	3.7	-		
*t _{d(ON)}	-	26.4	-	ns	V _{DS} =-15V, I _D =-100mA, V _{GS} =-4V, R _L =150Ω, R _G =50Ω
*t _r	-	12.8	-		
*t _{d(OFF)}	-	31.5	-		
*t _f	-	46.4	-		
*Q _g	-	0.78	-	nC	V _{DS} =-10V, I _D =-100mA, V _{GS} =-10V
*Q _{gs}	-	0.1	-		
*Q _{gd}	-	0.1	-		
Source-Drain Diode					
*I _S	-	-	-230	mA	
*I _{SM}	-	-	-920		
*V _{SD}	-	0.83	-1.2	V	V _{GS} =0V, I _S =-100mA

*Pulse Test : Pulse Width ≤300μs, Duty Cycle≤2%

Ordering Information

Device	Package	Shipping	Marking
MTP3LP01Y3	SOT-723 (Pb-free lead plating and halogen-free package)	8000 pcs / Tape & Reel	AB

Typical Characteristics(The minus sign in voltage and current is omitted)

Typical Output Characteristics

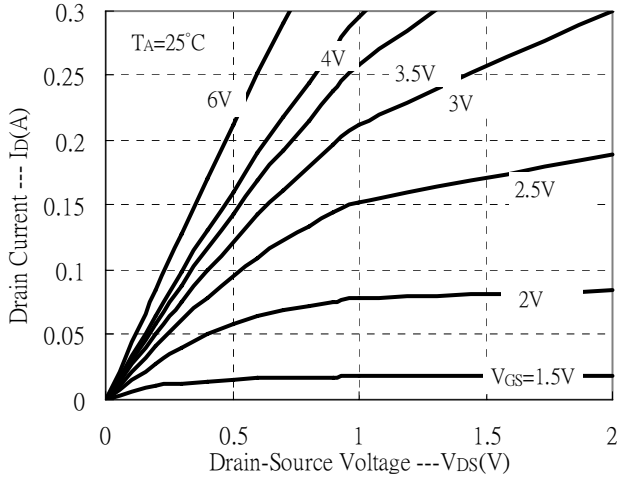

Typical Transfer Characteristics

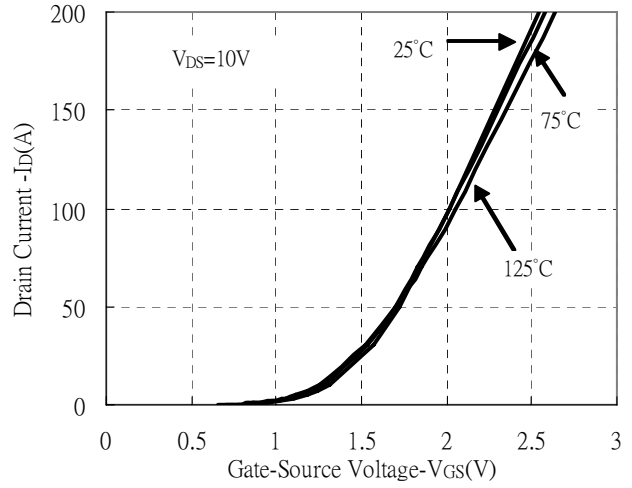

Static Drain-Source On-State Resistance vs Gate-Source Voltage

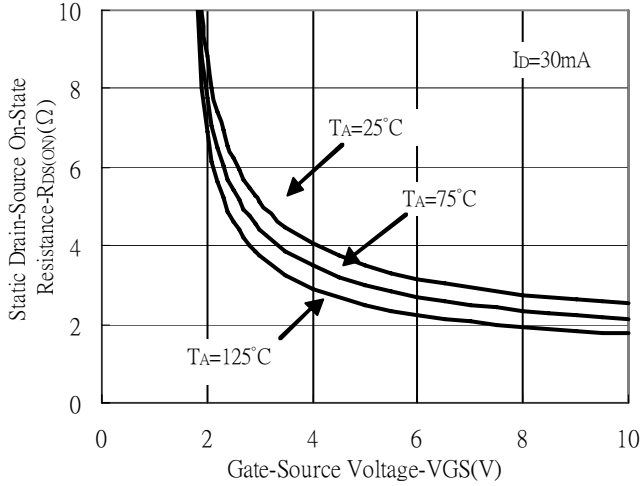

Static Drain-Source On-State Resistance vs Gate-Source Voltage

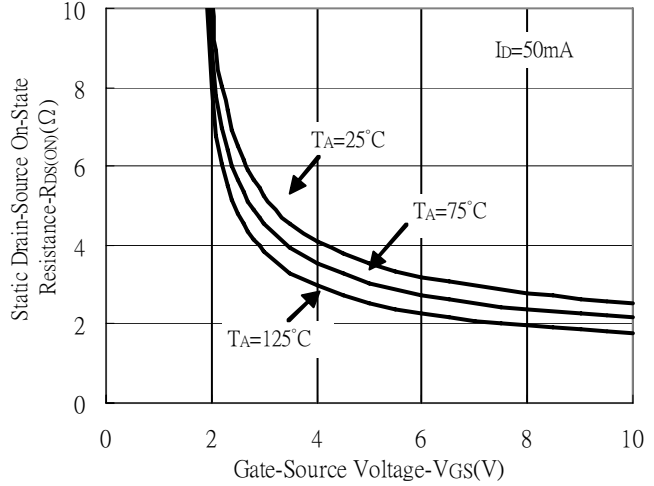

Static Drain-Source On-State resistance vs Drain Current

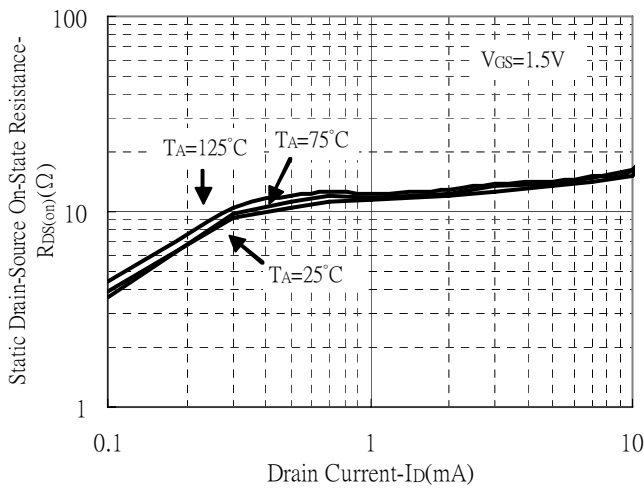

Static Drain-Source On-State resistance vs Drain Current

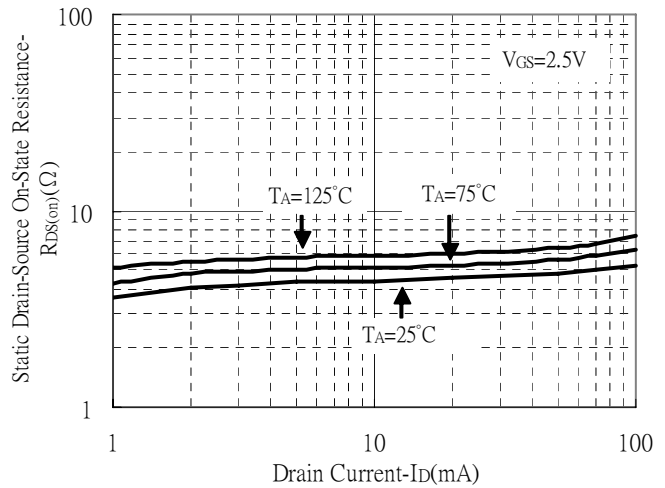

Typical Characteristics(Cont.)

Static Drain-Source On-State resistance vs Drain Current

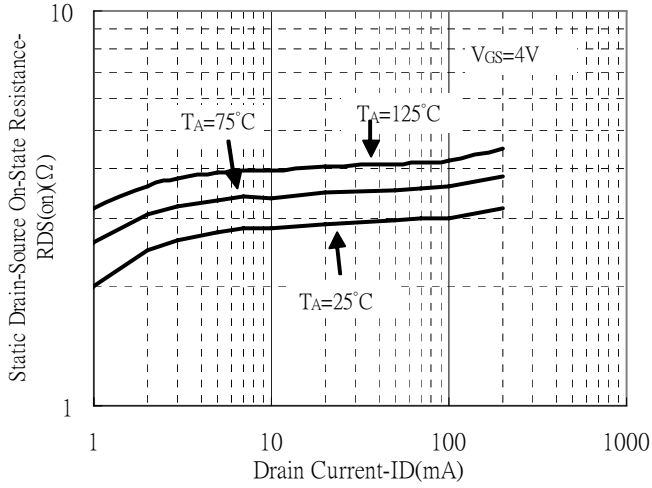

Static Drain-Source On-State resistance vs Ambient Temperature

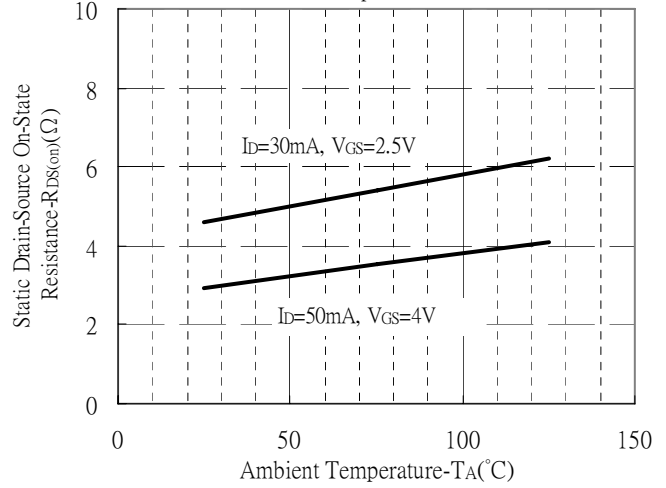

Reverse Drain Current vs Source-Drain Voltage

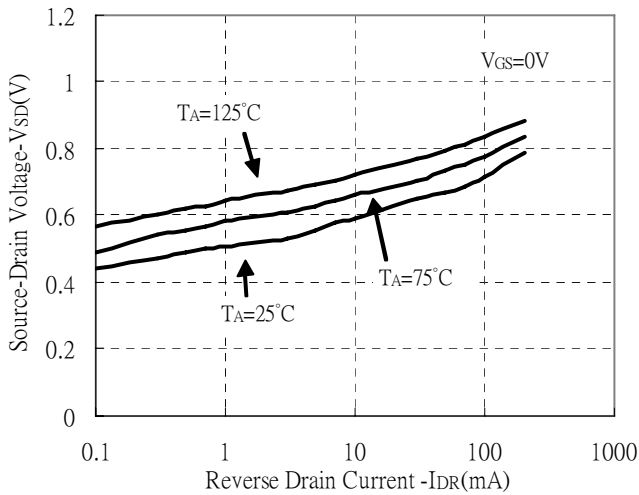

Capacitance vs Drain-to-Source Voltage

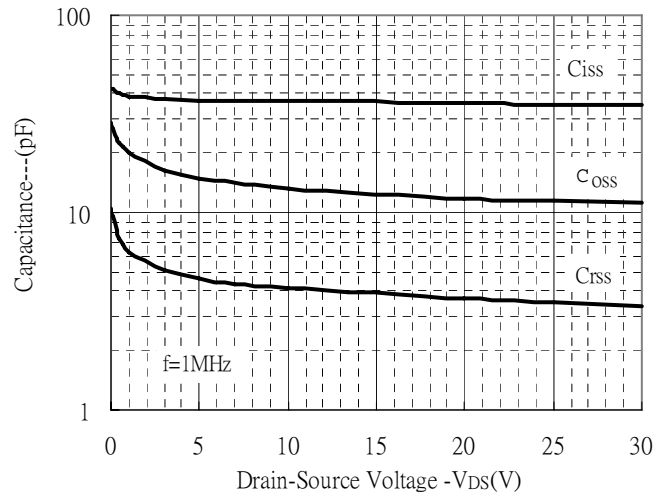

Forward Transfer Admittance vs Drain Current

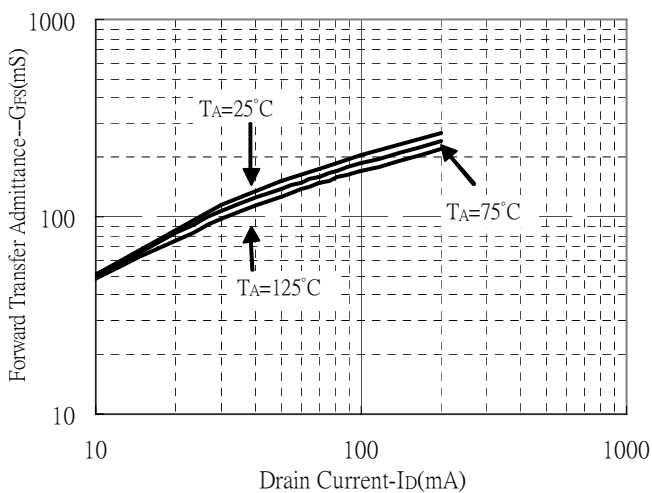

Brekdown Voltage vs Ambient Temperature

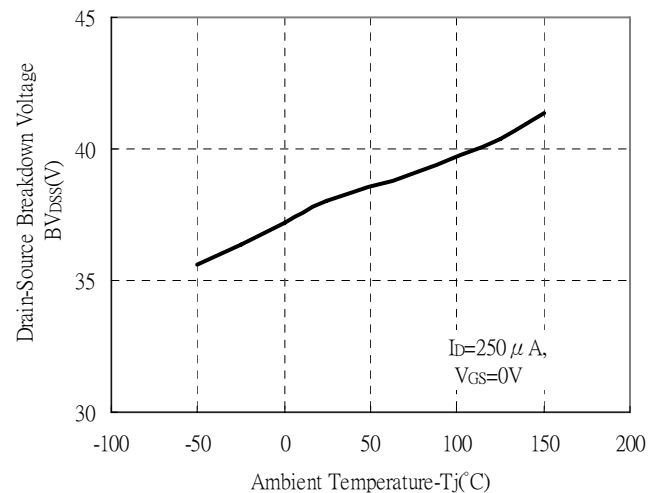



Typical Characteristics(Cont.)

Static Drain-Source On-resistance vs Ambient Temperature

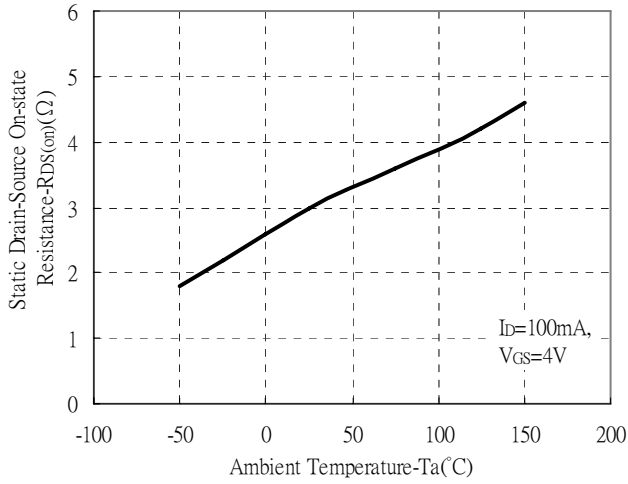

Gate Charge Characteristics

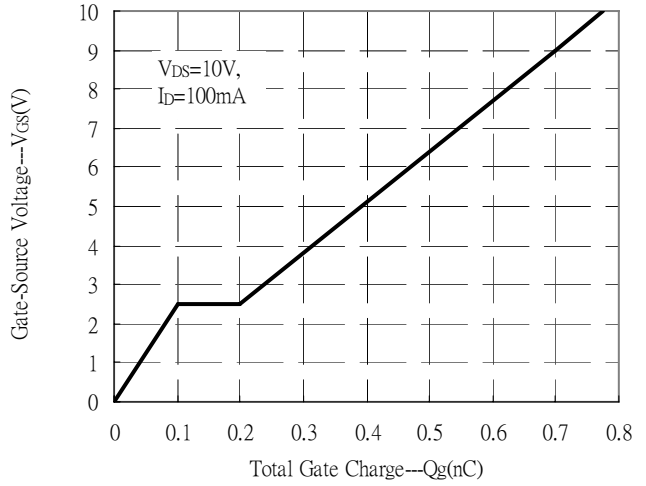

Power Derating Curve

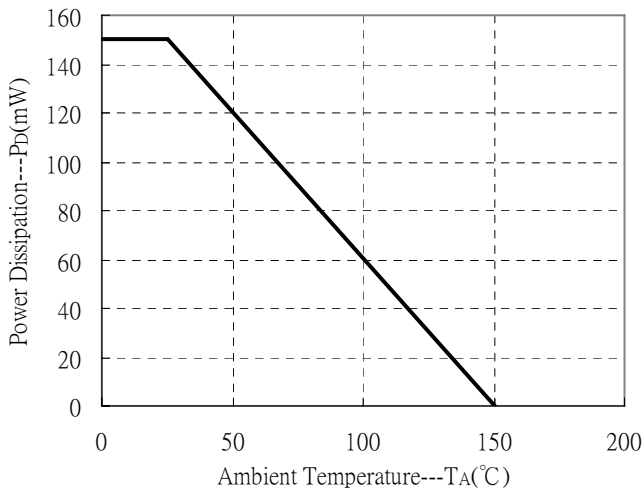

Reel Dimension

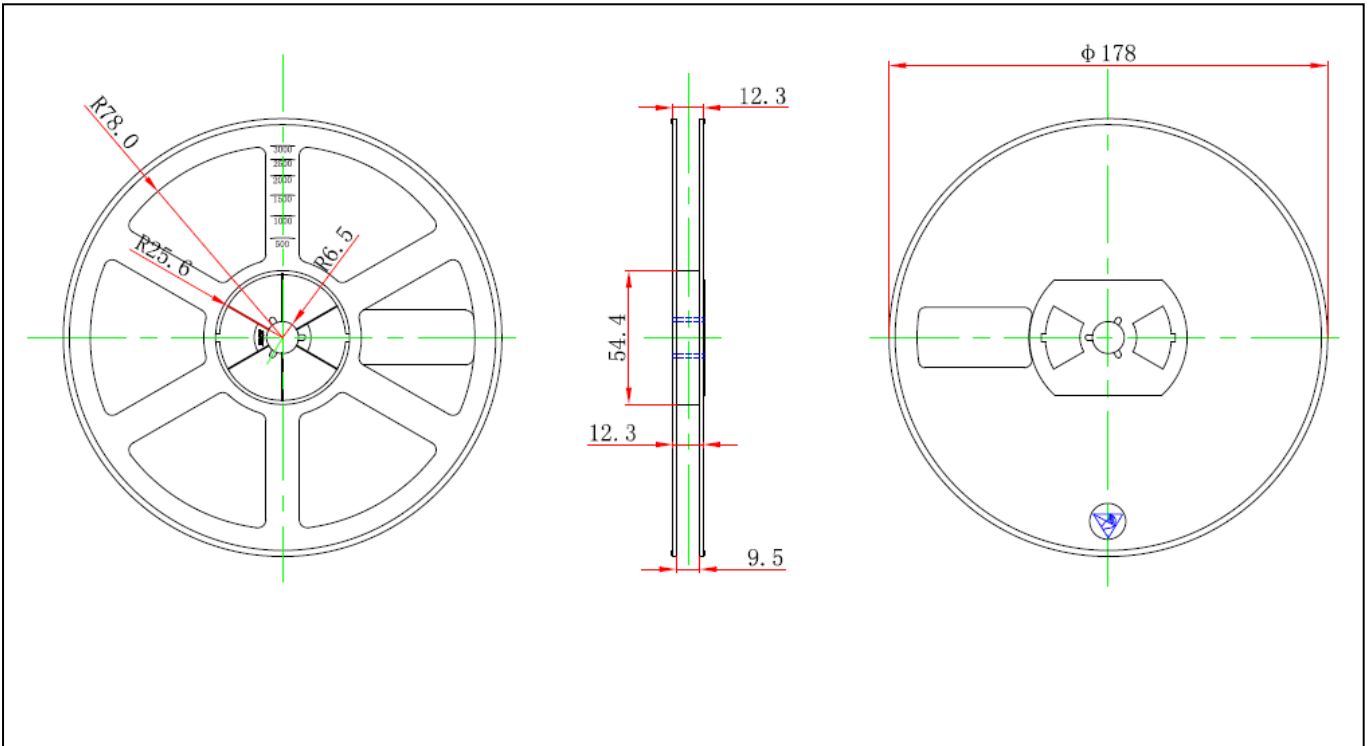

Carrier Tape Dimension

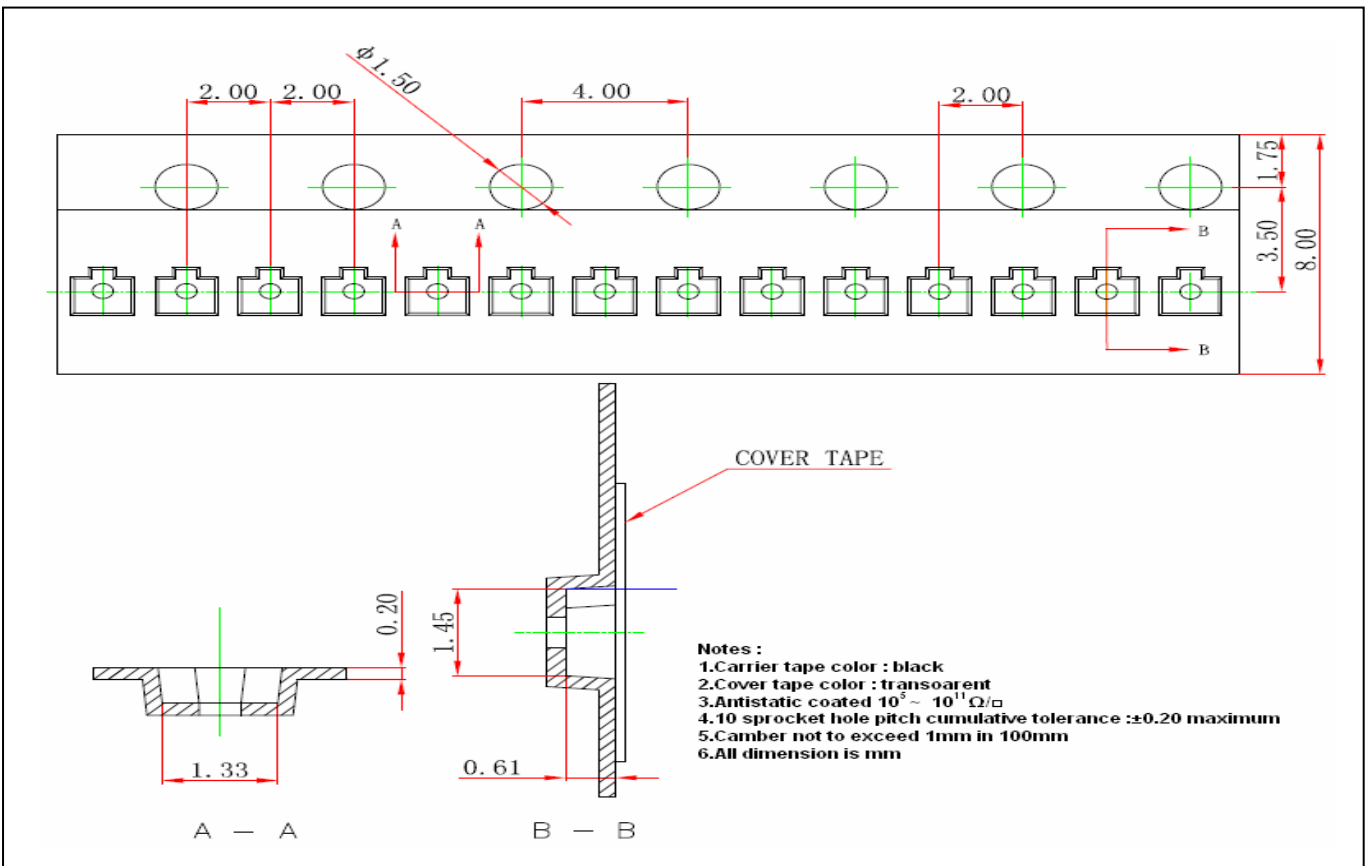

Recommended wave soldering condition

Product	Peak Temperature	Soldering Time
Pb-free devices	260 +0/-5 °C	5 +1/-1 seconds

Recommended temperature profile for IR reflow

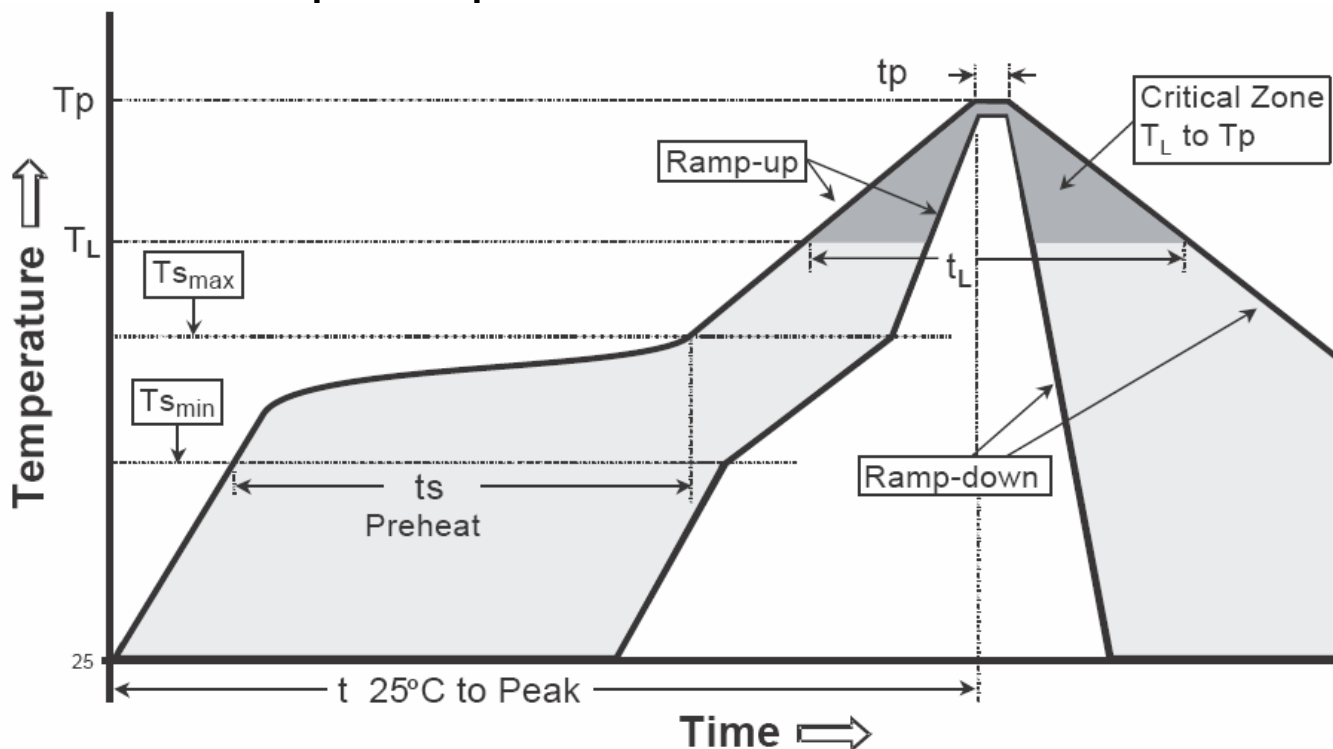

Profile feature	Sn-Pb eutectic Assembly	Pb-free Assembly
Average ramp-up rate (T _{smax} to T _p)	3°C/second max.	3°C/second max.
Preheat		
-Temperature Min(T _{s min})	100°C	150°C
-Temperature Max(T _{s max})	150°C	200°C
-Time(t _{s min} to t _{s max})	60-120 seconds	60-180 seconds
Time maintained above:		
-Temperature (T _L)	183°C	217°C
- Time (t _L)	60-150 seconds	60-150 seconds
Peak Temperature(T _P)	240 +0/-5 °C	260 +0/-5 °C
Time within 5°C of actual peak temperature(t _p)	10-30 seconds	20-40 seconds
Ramp down rate	6°C/second max.	6°C/second max.
Time 25 °C to peak temperature	6 minutes max.	8 minutes max.

Note : All temperatures refer to topside of the package, measured on the package body surface.

SOT-723 Dimension

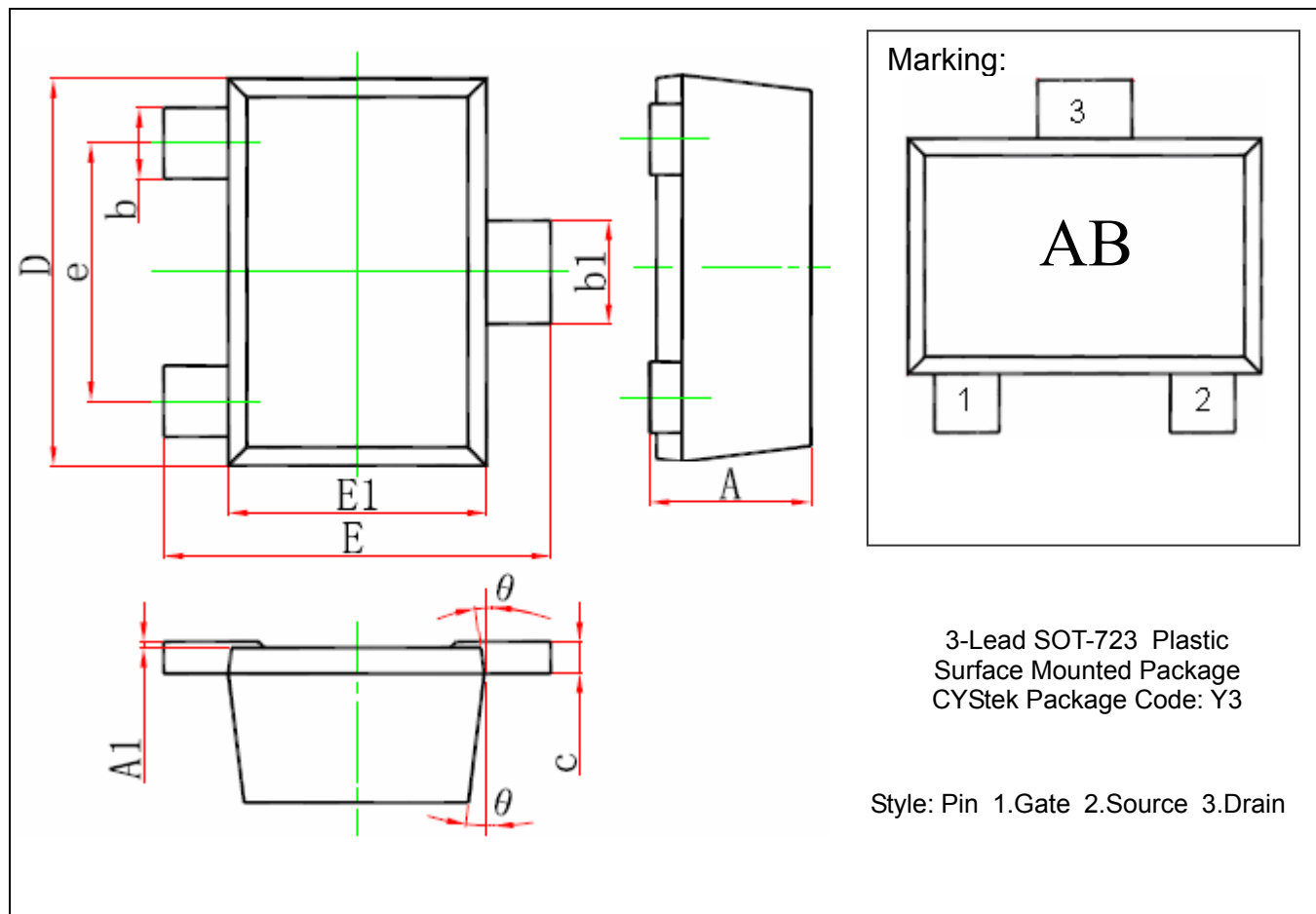

*Typical

DIM	Millimeters		Inches		DIM	Millimeters		Inches	
	Min.	Max.	Min.	Max.		Min.	Max.	Min.	Max.
A	0.000	0.500	0.000	0.020	D	1.150	1.250	0.045	0.049
A1	0.000	0.050	0.000	0.002	E	1.150	1.250	0.045	0.049
b	0.170	0.270	0.007	0.011	E1	0.750	0.850	0.030	0.033
b1	0.270	0.370	0.011	0.015	e	0.800*		0.031*	
c	0.000	0.150	0.000	0.006	θ	7° REF		7° REF	

Notes: 1.Controlling dimension: millimeters.
 2.Maximum lead thickness includes lead finish thickness, and minimum lead thickness is the minimum thickness of base material.
 3.If there is any question with packing specification or packing method, please contact your local CYStek sales office.

Material:

- Lead: Pure tin plated.
- Mold Compound: Epoxy resin family, flammability solid burning class: UL94V-0.

Important Notice:

- All rights are reserved. Reproduction in whole or in part is prohibited without the prior written approval of CYStek.
- CYStek reserves the right to make changes to its products without notice.
- CYStek **semiconductor products are not warranted to be suitable for use in Life-Support Applications, or systems.**
- CYStek assumes no liability for any consequence of customer product design, infringement of patents, or application assistance.