

**-30V P-CHANNEL Enhancement Mode MOSFET**

# MTP4411M3

<b>BV<sub>DSS</sub></b>	<b>-30V</b>
<b>I<sub>D</sub></b>	<b>-5A</b>
<b>R<sub>DS(on)</sub>@ V<sub>GS</sub>=-10V, I<sub>D</sub>=-4A</b>	<b>40mΩ (typ.)</b>
<b>R<sub>DS(on)</sub>@ V<sub>GS</sub>=-4.5V, I<sub>D</sub>=-3A</b>	<b>58mΩ (typ.)</b>

**Features**

- Single Drive Requirement
- Ultra High Speed Switching
- Pb-free lead plating package

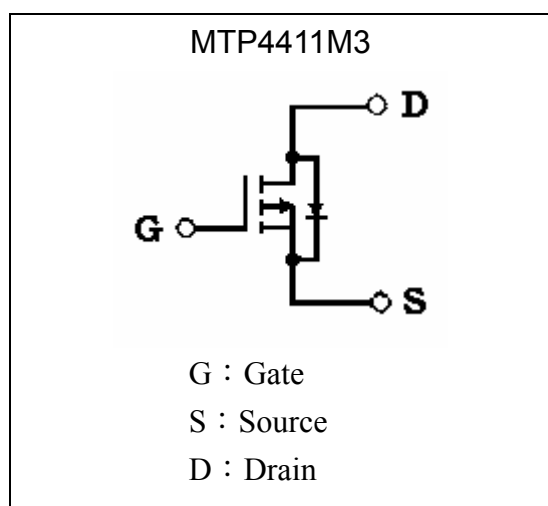
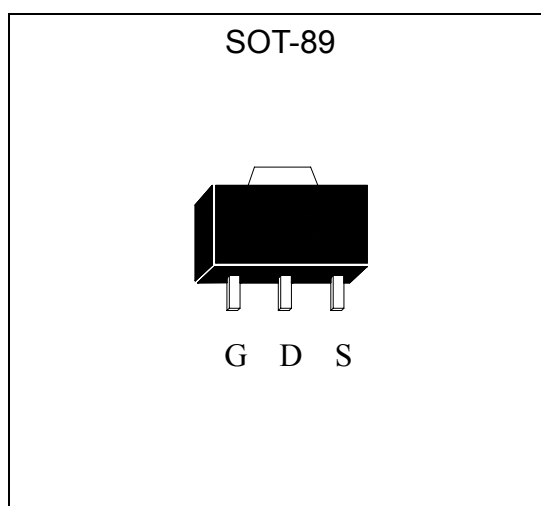
**Symbol**

**Outline**

**Absolute Maximum Ratings (T<sub>a</sub>=25°C)**

Parameter	Symbol	Limits	Unit
Drain-Source Voltage	V <sub>DS</sub>	-30	V
Gate-Source Voltage	V <sub>GS</sub>	±20	V
Continuous Drain Current @ T <sub>A</sub> =25°C	I <sub>D</sub>	-5	A
Continuous Drain Current @ T <sub>A</sub> =70°C	I <sub>D</sub>	-4	A
Pulsed Drain Current	I <sub>DM</sub>	-20 *1, 3	A
Total Power Dissipation (T <sub>A</sub> =25°C)	P <sub>d</sub>	1.5 *2	W
Linear Derating Factor		0.01	W/°C
Operating Junction and Storage Temperature	T <sub>j</sub> , T <sub>stg</sub>	-55~+150	°C

Note : \*1. Pulse width limited by maximum junction temperature

 \*2. Surface mounted on 1 in<sup>2</sup> copper pad of FR-4 board; 250 °C/W when mounted on min. copper pad

\*3. Pulse width ≤ 300μs, duty cycle ≤ 2%



**Thermal Data**

Parameter	Symbol	Value	Unit
Thermal Resistance, Junction-to-case, max	R <sub>th,j-c</sub>	17	°C/W
Thermal Resistance, Junction-to-ambient, max	R <sub>th,j-a</sub>	83.3 (Note)	°C/W

Note : When mounted on a 1 in<sup>2</sup> pad of 2 oz. copper; 250 °C/W when mounted on min. copper pad

**Electrical Characteristics (T<sub>j</sub>=25°C, unless otherwise noted)**

Symbol	Min.	Typ.	Max.	Unit	Test Conditions
<b>Static</b>					
BV <sub>DSS</sub>	-30	-	-	V	V <sub>GS</sub> =0, I <sub>D</sub> =-250μA
V <sub>GS(th)</sub>	-1	-1.4	-2.5	V	V <sub>DS</sub> =V <sub>GS</sub> , I <sub>D</sub> =-250μA
G <sub>FS</sub>	-	5	-	S	V <sub>DS</sub> =-10V, I <sub>D</sub> =-4A
I <sub>GSS</sub>	-	-	±100	nA	V <sub>GS</sub> =±20V, V <sub>DS</sub> =0
I <sub>DSS</sub>	-	-	-1	μA	V <sub>DS</sub> =-24V, V <sub>GS</sub> =0
	-	-	-10	μA	V <sub>DS</sub> =-20V, V <sub>GS</sub> =0 (T <sub>j</sub> =125°C)
*R <sub>DS(ON)</sub>	-	40	45	mΩ	I <sub>D</sub> =-4A, V <sub>GS</sub> =-10V
	-	58	75		I <sub>D</sub> =-3A, V <sub>GS</sub> =-4.5V
<b>Dynamic</b>					
C <sub>iss</sub>	-	796	-	pF	V <sub>DS</sub> =-15V, V <sub>GS</sub> =0, f=1MHz
C <sub>oss</sub>	-	88	-		
C <sub>rss</sub>	-	71	-		
*t <sub>d(ON)</sub>	-	6	-	ns	V <sub>DS</sub> =-15V, I <sub>D</sub> =-1A, V <sub>GS</sub> =-10V, R <sub>G</sub> =6Ω
*t <sub>r</sub>	-	10	-		
*t <sub>d(OFF)</sub>	-	18	-		
*t <sub>f</sub>	-	5	-		
*Q <sub>g</sub>	-	11	-	nC	V <sub>DS</sub> =-15V, I <sub>D</sub> =-4A, V <sub>GS</sub> =-10V
*Q <sub>gs</sub>	-	2	-		
*Q <sub>gd</sub>	-	3	-		
<b>Source-Drain Diode</b>					
*I <sub>S</sub>	-	-	-2.3	A	
*I <sub>SM</sub>	-	-	-9.2		
*V <sub>SD</sub>	-	-0.76	-1.2	V	V <sub>GS</sub> =0V, I <sub>S</sub> =-1A

\*Pulse Test : Pulse Width ≤300μs, Duty Cycle ≤2%

**Ordering Information**

Device	Package	Shipping	Marking
MTP4411M3	SOT-89 (Pb-free lead plating package)	1000 pcs / Tape & Reel	4411

## Typical Characteristics

Typical Output Characteristics

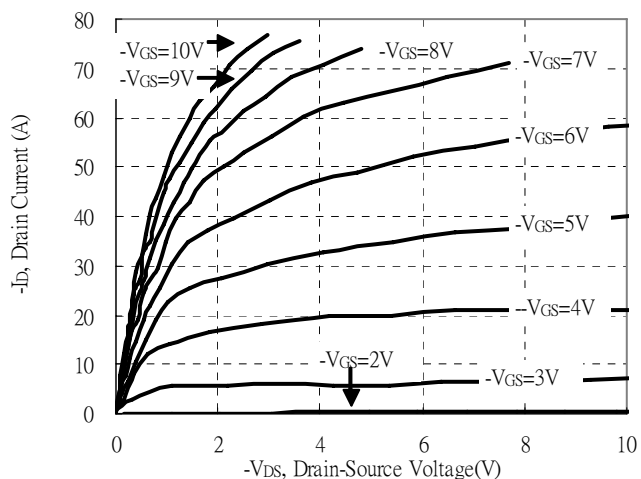

Brekdown Voltage vs Ambient Temperature

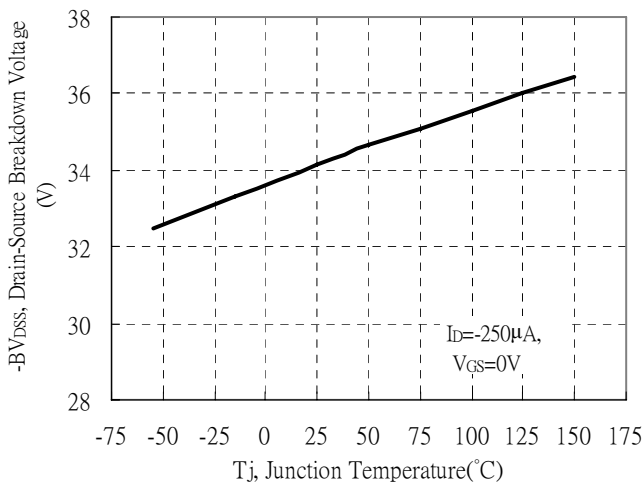

Static Drain-Source On-State resistance vs Drain Current

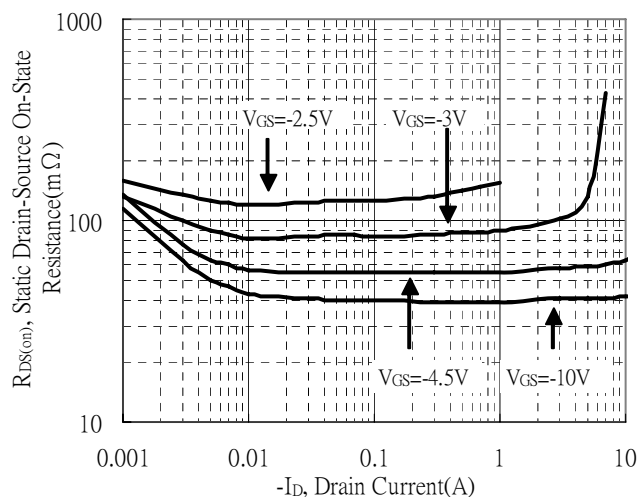

Reverse Drain Current vs Source-Drain Voltage

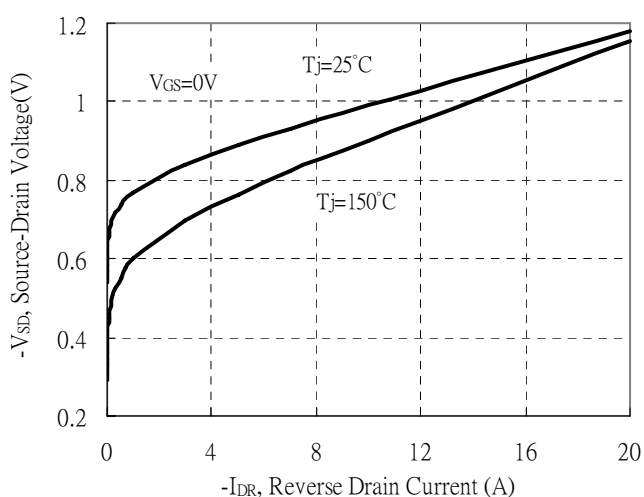

Static Drain-Source On-State Resistance vs Gate-Source Voltage

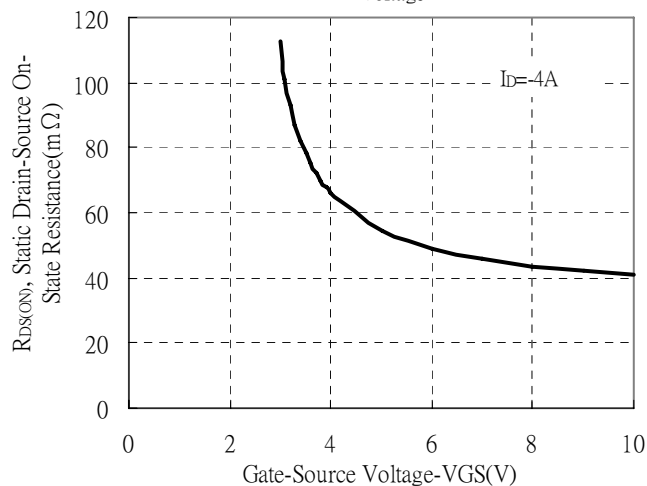

Drain-Source On-State Resistance vs Junction Temperature

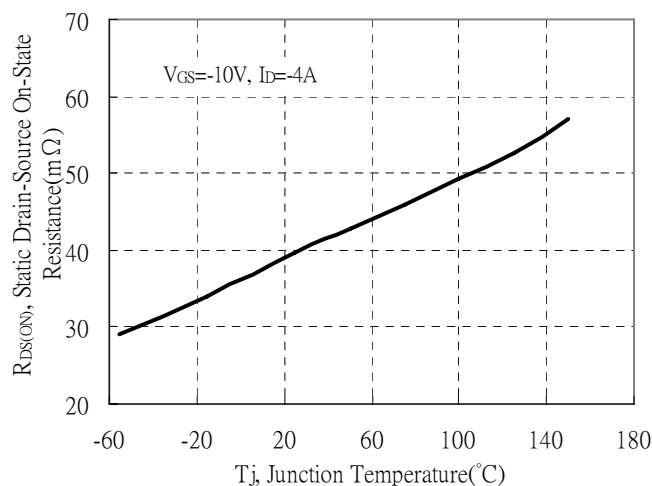

## Typical Characteristics(Cont.)

Capacitance vs Drain-to-Source Voltage

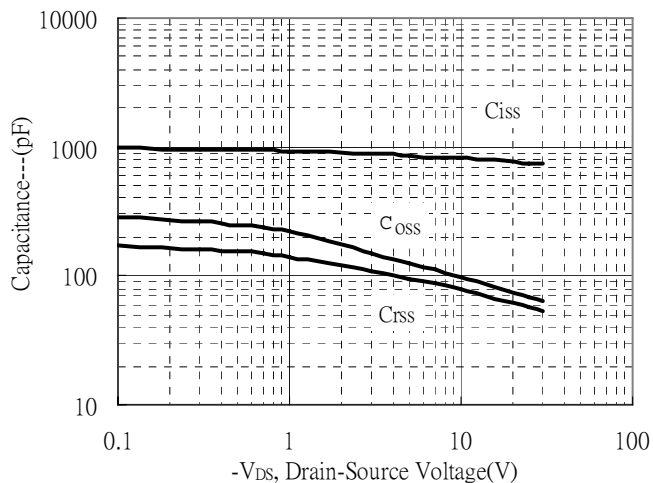

Normalized Threshold Voltage vs Junction Temperature

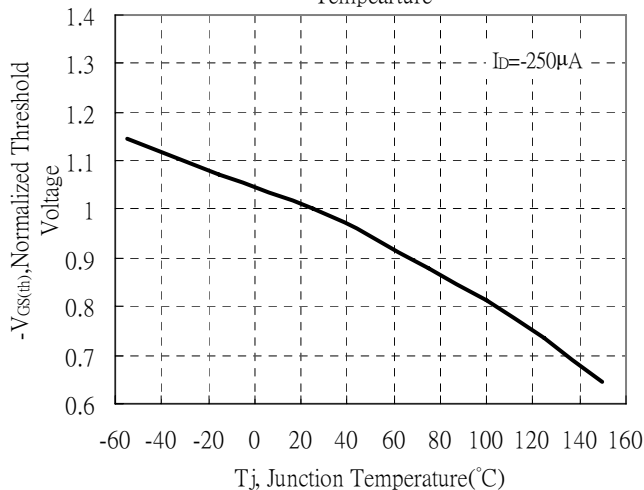

Forward Transfer Admittance vs Drain Current

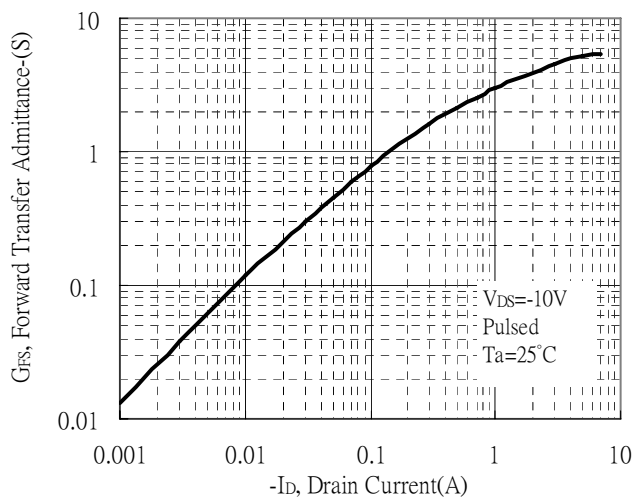

Gate Charge Characteristics

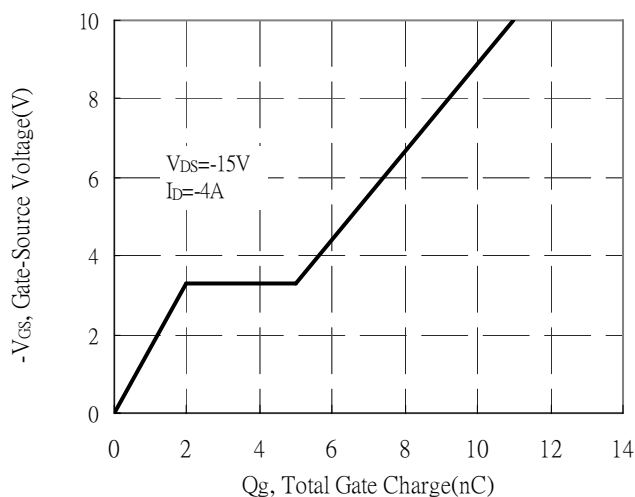

Maximum Safe Operating Area

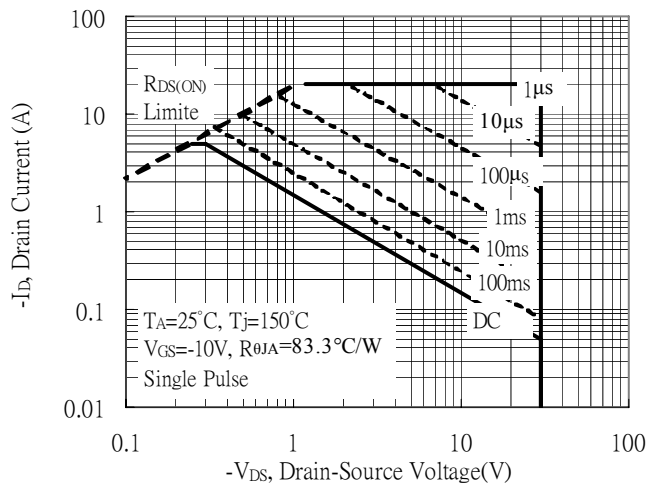

Maximum Drain Current vs Junction Temperature

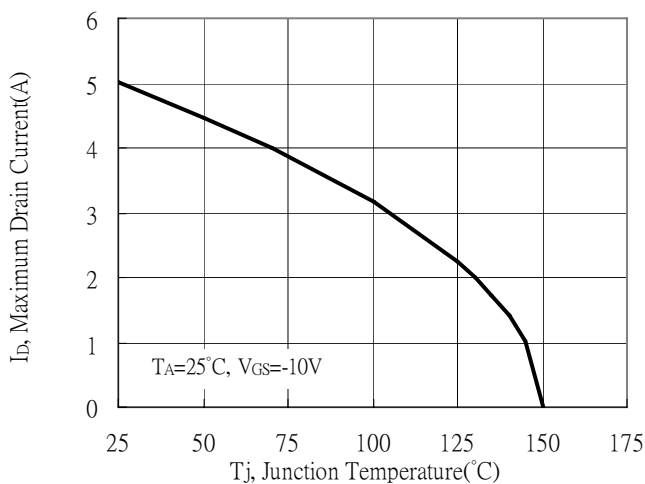

**Typical Characteristics(Cont.)**

Typical Transfer Characteristics

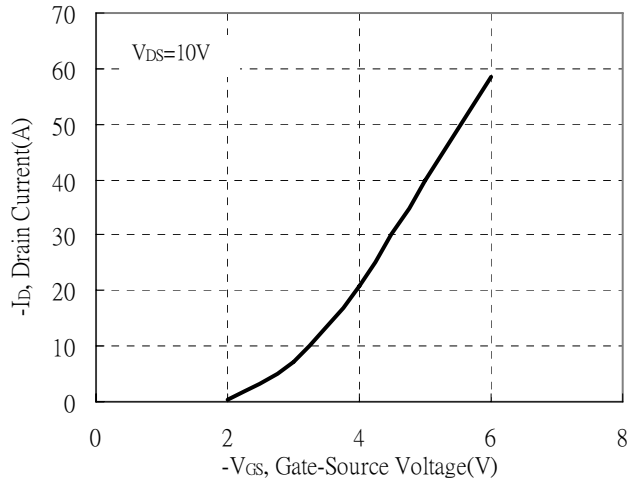

Transient Thermal Response Curves

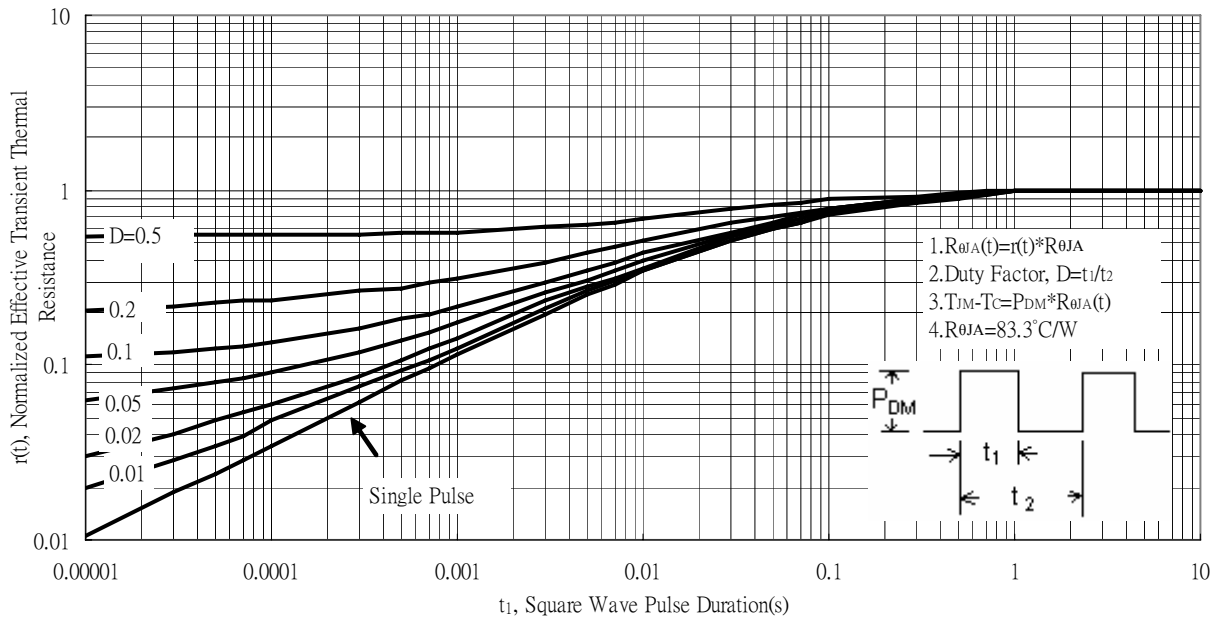

### Reel Dimension

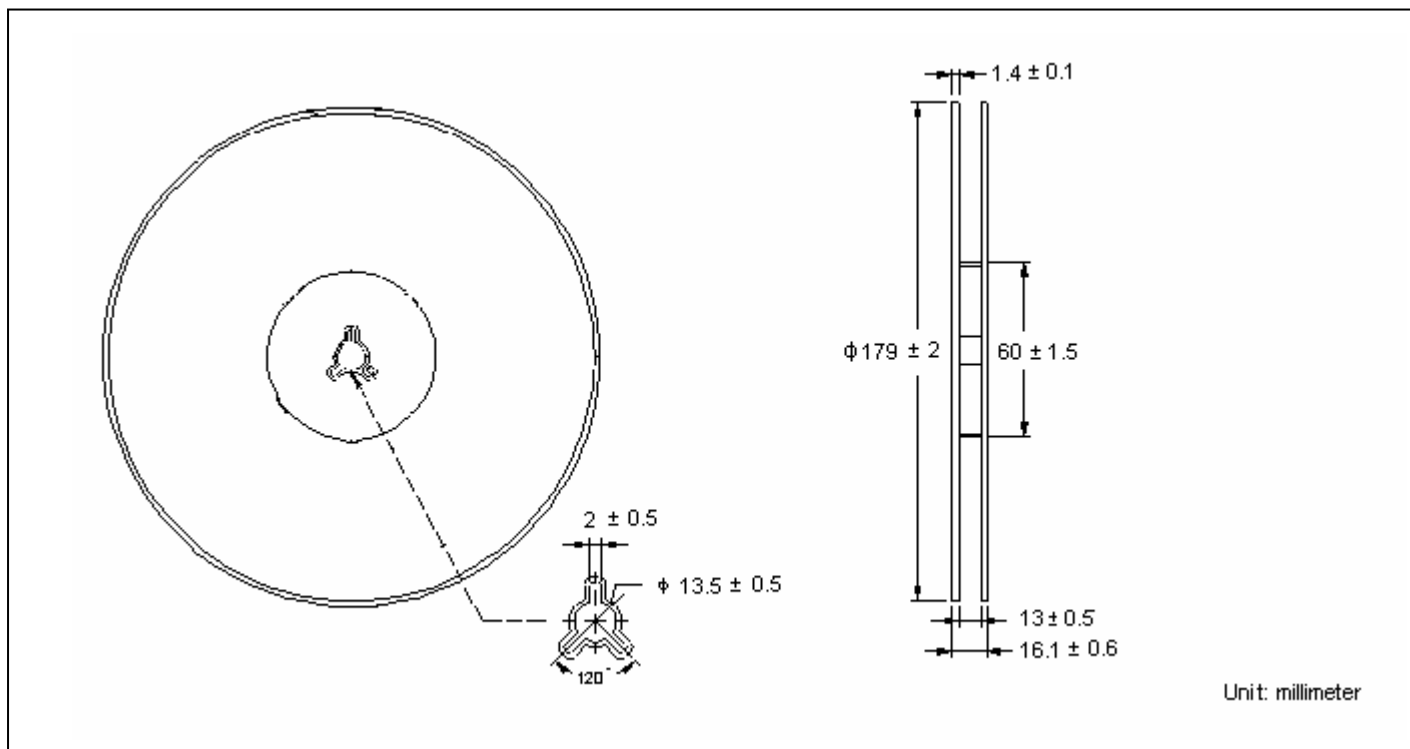

### Carrier Tape Dimension

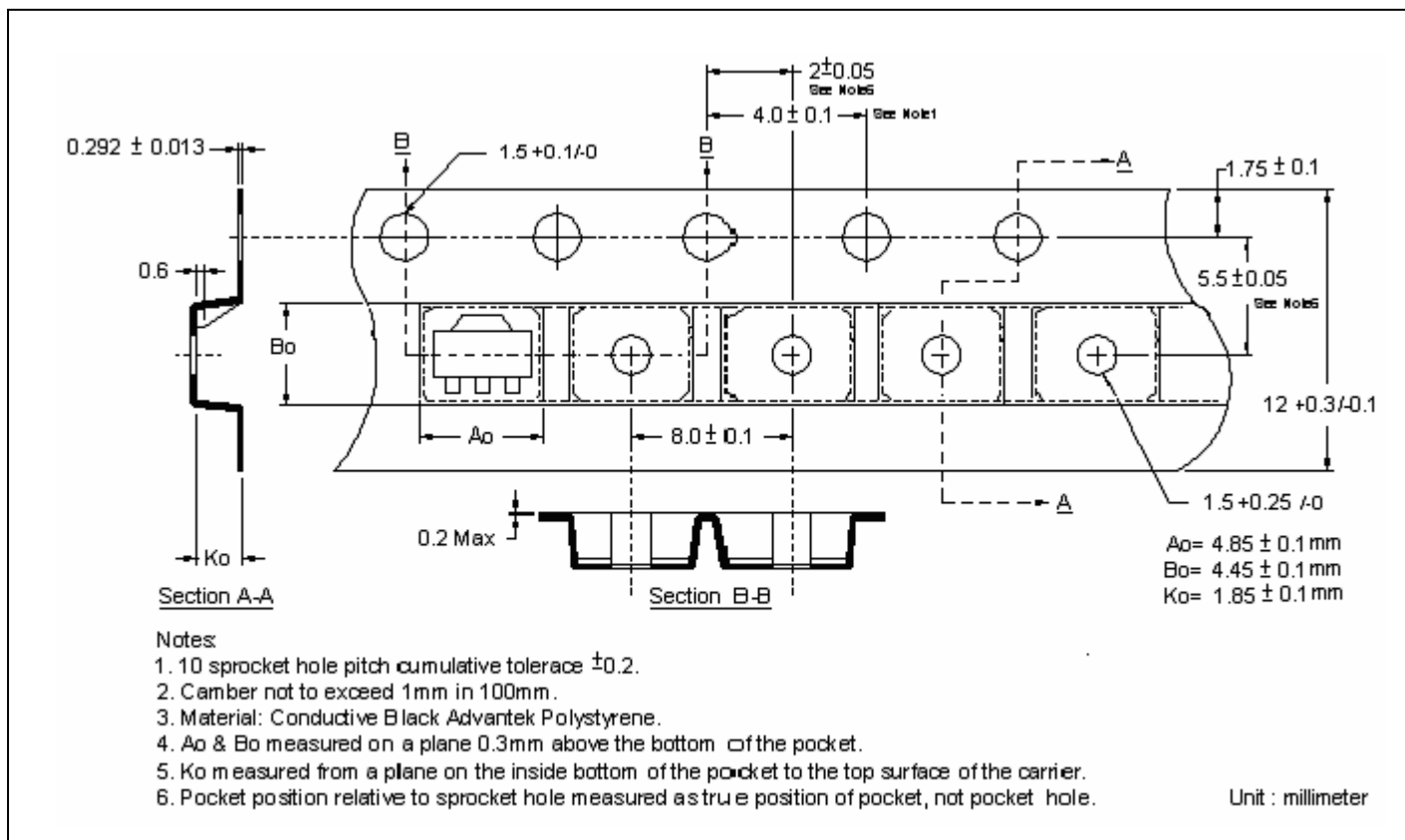

**Recommended wave soldering condition**

Product	Peak Temperature	Soldering Time
Pb-free devices	260 +0/-5 °C	5 +1/-1 seconds

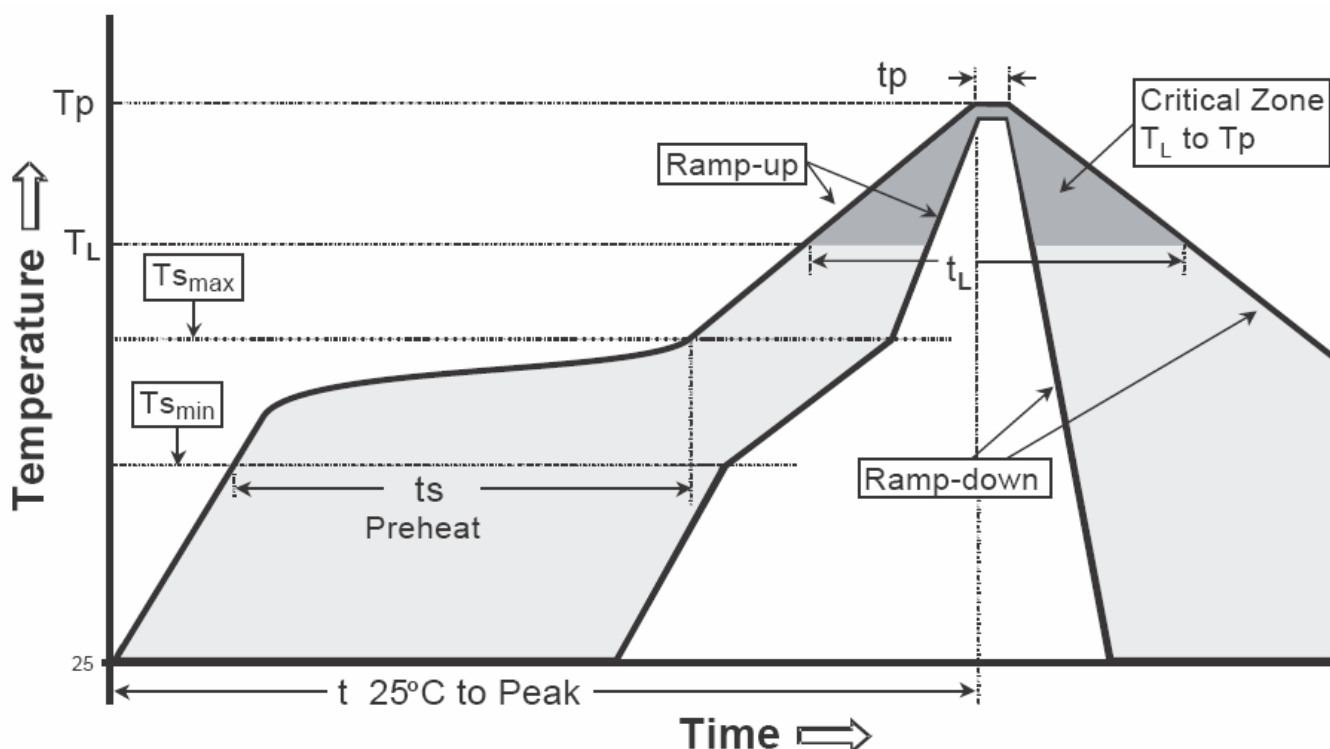
**Recommended temperature profile for IR reflow**

Profile feature	Sn-Pb eutectic Assembly	Pb-free Assembly
Average ramp-up rate (Tsmax to Tp)	3°C/second max.	3°C/second max.
Preheat		
-Temperature Min(Ts min)	100°C	150°C
-Temperature Max(Ts max)	150°C	200°C
-Time(ts min to ts max)	60-120 seconds	60-180 seconds
Time maintained above:		
-Temperature (TL)	183°C	217°C
- Time (tL)	60-150 seconds	60-150 seconds
Peak Temperature(TP)	240 +0/-5 °C	260 +0/-5 °C
Time within 5°C of actual peak temperature(tp)	10-30 seconds	20-40 seconds
Ramp down rate	6°C/second max.	6°C/second max.
Time 25 °C to peak temperature	6 minutes max.	8 minutes max.

Note : All temperatures refer to topside of the package, measured on the package body surface.

**SOT-89 Dimension**

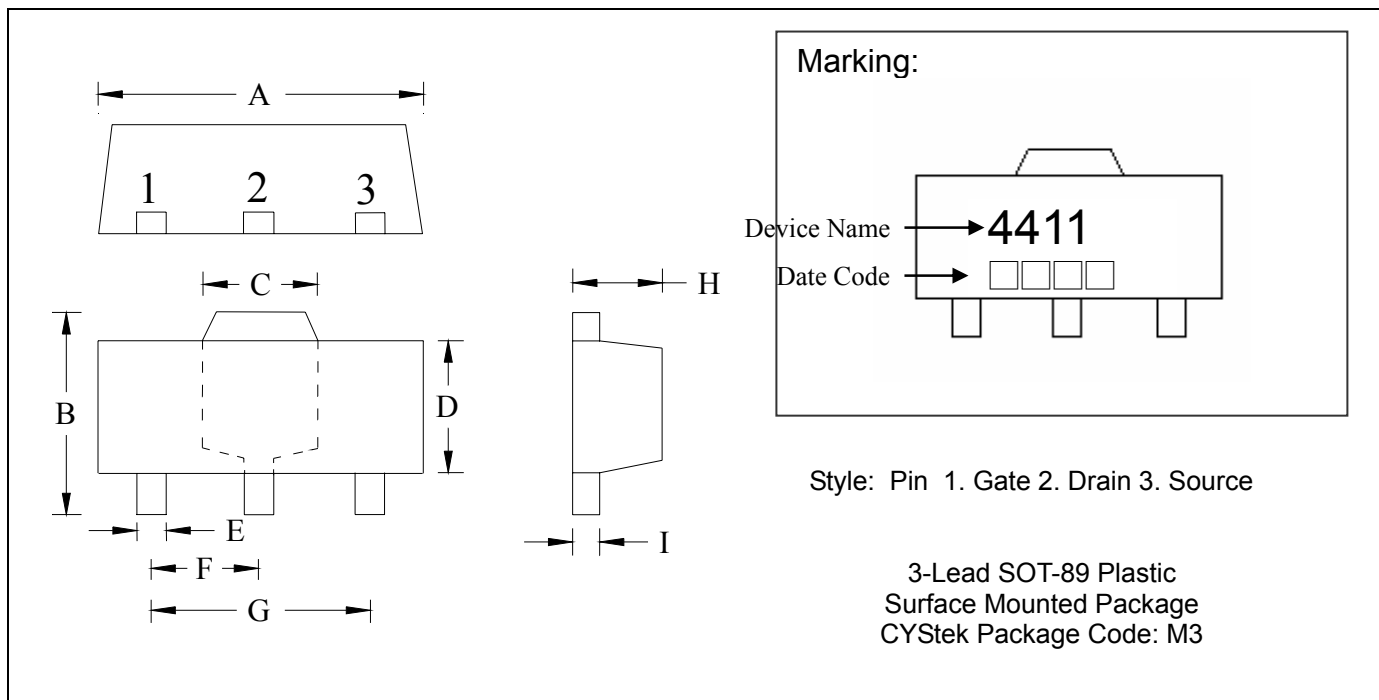

DIM	Inches		Millimeters		DIM	Inches		Millimeters	
	Min.	Max.	Min.	Max.		Min.	Max.	Min.	Max.
A	0.1732	0.1811	4.40	4.60	F	0.0591	TYP	1.50	TYP
B	0.1551	0.1673	3.94	4.25	G	0.1181	TYP	3.00	TYP
C	0.0610	REF	1.55	REF	H	0.0551	0.0630	1.40	1.60
D	0.0906	0.1024	2.30	2.60	I	0.0138	0.0173	0.35	0.44
E	0.0126	0.0205	0.32	0.52					

**Notes:** 1.Controlling dimension: millimeters.  
 2.Maximum lead thickness includes lead finish thickness, and minimum lead thickness is the minimum thickness of base material.  
 3.If there is any question with packing specification or packing method, please contact your local CYStek sales office.

**Material:**

- Lead: Pure tin plated.
- Mold Compound: Epoxy resin family, flammability solid burning class: UL94V-0.

**Important Notice:**

- All rights are reserved. Reproduction in whole or in part is prohibited without the prior written approval of CYStek.
- CYStek reserves the right to make changes to its products without notice.
- CYStek **semiconductor products are not warranted to be suitable for use in Life-Support Applications, or systems.**
- CYStek assumes no liability for any consequence of customer product design, infringement of patents, or application assistance.