

N- Channel Enhancement mode MOSFET AND PNP BJT Complex Device

MBNP2074G6

Description

The MBNP2074G6 consists of a N-channel enhancement-mode MOSFET and a PNP BJT in a single TSOP-6 package, providing the designer with the best combination of fast switching, ruggedized device design, low on-resistance and cost-effectiveness.

The TSOP-6 package is universally preferred for all commercial-industrial surface mount applications.

Features

- Simple drive requirement
- Low gate charge
- Low on-resistance
- Fast switching speed
- Pb-free package

Equivalent Circuit

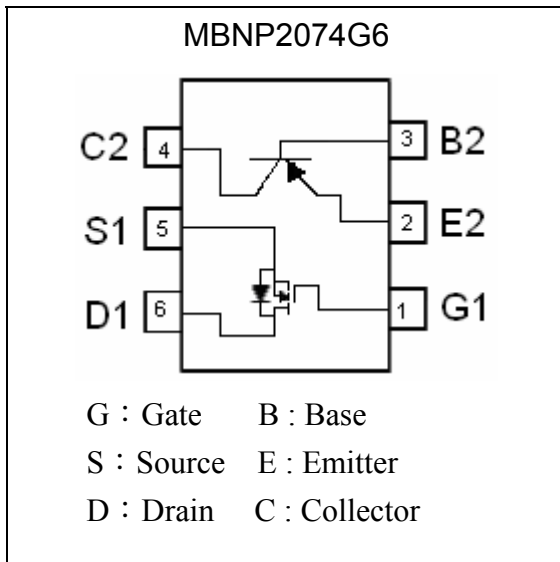

Outline

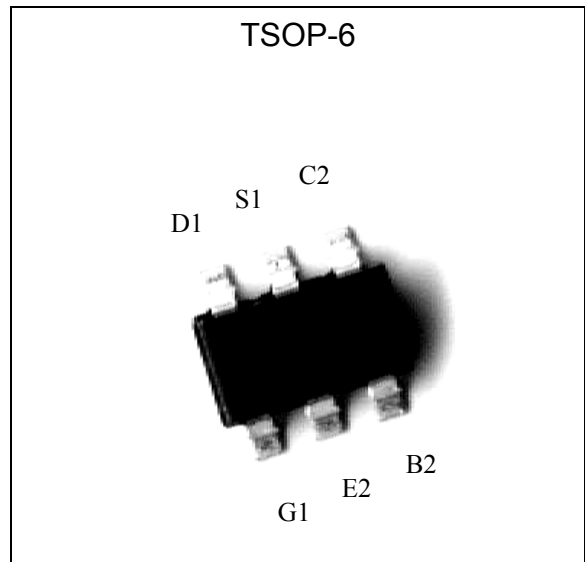



Absolute Maximum Ratings (Ta=25°C)

Parameter	Symbol	Limits		Unit
		N-channel	PNP	
Drain-Source Breakdown Voltage	BV _{DSS}	30		V
Gate-Source Voltage	V _{GS}	±12		V
Collector-Base Voltage	V _{CB0}		-50	V
Collector-Emitter Voltage	V _{CEO}		-30	V
Emitter-Base Voltage	V _{EBO}		-7	V
Continuous Drain Current (Note 1)	I _D	100		mA
Pulsed Drain Current (Note 2)	I _{DM}	400		mA
Collector Current(DC) (Note 1)	I _C		-1.5	A
Peak Collector Current (Note 2)	I _{CM}		-3	A
Peak Base Current (Note 2)	I _{BM}		-300	mA
Total Power Dissipation (Note 1) Linear Derating Factor	Pd	1.14		W
		0.01		W / °C
Operating Junction and Storage Temperature	T _j , T _{stg}	-55~+150		°C
Thermal Resistance, Junction-to-Ambient (Note 1)	R _{th,ja}	110		°C/W

Note : 1.Surface mounted on 1 in² copper pad of FR-4 board, t≤5 sec; 180°C/W when mounted on minimum copper pad
 2.Pulse width limited by maximum junction temperature

N-Channel MOSFET Electrical Characteristics (Tj=25°C, unless otherwise specified)

Symbol	Min.	Typ.	Max.	Unit	Test Conditions
Static					
BV _{DSS}	30	-	-	V	V _{GS} =0, I _D =100μA
V _{GS(th)}	0.8	1.3	1.5	V	V _{DS} =3V, I _D =100μA
I _{GSS}	-	-	±1	μA	V _{GS} =±20V, V _{DS} =0
I _{DSS}	-	-	100	nA	V _{DS} =30V, V _{GS} =0
R _{DS(ON)}	-	3.4	8	Ω	V _{GS} =4V, I _D =10mA
	-	6.9	13		V _{GS} =2.5V, I _D =1mA
G _{FS}	20	50	-	mS	V _{DS} =3V, I _D =10mA
Dynamic					
C _{iSS}	-	12.5	-	pF	V _{DS} =5V, V _{GS} =0, f=1MHz
C _{oSS}	-	7.3	-		
C _{rSS}	-	3.5	-		
*t _{d(ON)}	-	15	-	ns	V _{DD} ≐ 5V, I _D =10mA, V _{GS} =5V, R _L =500Ω, R _G =10Ω
*t _r	-	35	-		
*t _{d(OFF)}	-	75	-		
*t _f	-	75	-		
R _g	-	1.1	1.7	Ω	f=1MHz
Source-Drain Diode					
*V _{SD}	-	0.88	1.2	V	V _{GS} =0V, I _S =100mA

*Pulse Test : Pulse Width ≤300μs, Duty Cycle ≤2%



PNP BJT Electrical Characteristics (Tj=25°C, unless otherwise specified)

Symbol	Min.	Typ.	Max.	Unit	Test Conditions
BV _{CBO}	-50	-	-	V	I _C =-50μA, I _E =0
BV _{CEO}	-30	-	-	V	I _C =-1mA, I _B =0
BV _{EBO}	-7	-	-	V	I _E =-50μA, I _C =0
I _{CBO}	-	-	-100	nA	V _{CB} =-50V, I _E =0
I _{EBO}	-	-	-100	nA	V _{EB} =-7V, I _C =0
*V _{CE(sat)}	-	-0.24	-0.4	V	I _C =-500mA, I _B =-20mA
*V _{CE(sat)}	-	-	-0.5	V	I _C =-800mA, I _B =-80mA
*V _{BE(on)}	-0.5	-	-0.8	V	V _{CE} =-1V, I _C =-10mA
*h _{FE 1}	120	-	390	-	V _{CE} =-1V, I _C =-100mA
*h _{FE 2}	40	-	-	-	V _{CE} =-1V, I _C =-800mA
f _T	-	150	-	MHz	V _{CE} =-5V, I _C =-10mA, f=100MHz
C _{ob}	-	12	-	pF	V _{CB} =-10V, f=1MHz

*Pulse Test : Pulse Width ≤380μs, Duty Cycle ≤2%

Ordering Information

Device	Package	Shipping	Marking
MBNP2074G6	TSOP-6 (Pb-free lead plating & halogen-free package)	3000 pcs / Tape & Reel	2074



N-channel MOSFET Characteristic Curves

Typical Output Characteristics

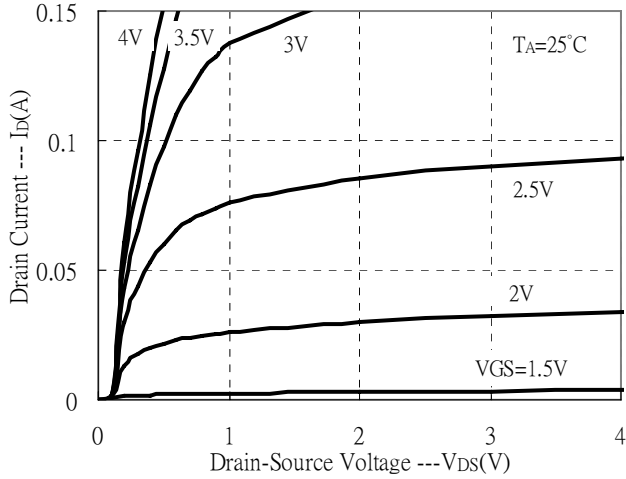

Gate Threshold Voltage vs Channel Temperature

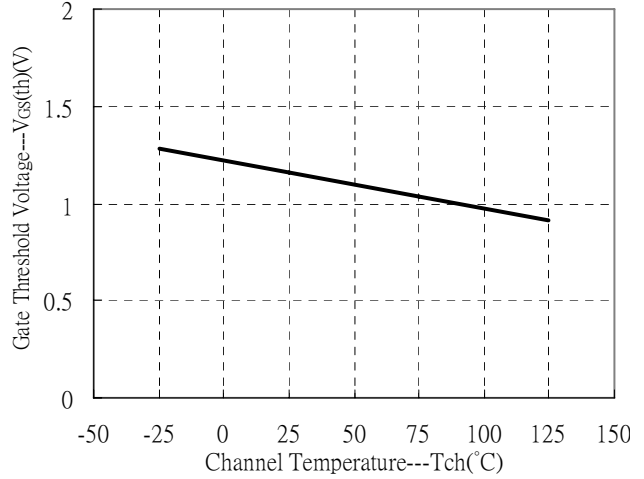

Typical Transfer Characteristics

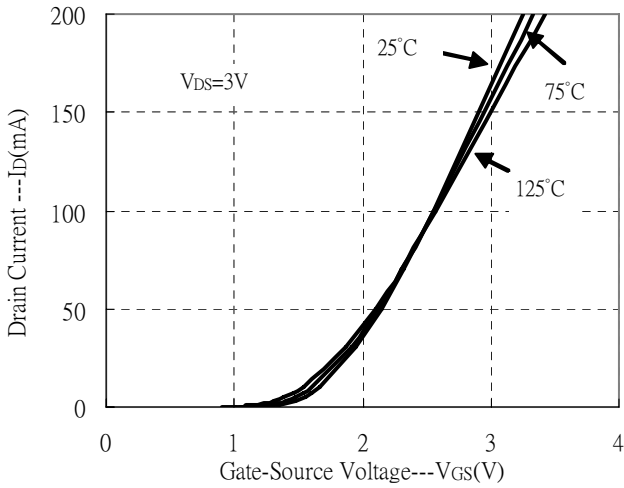

Static Drain-Source On-state Resistance with Temperature

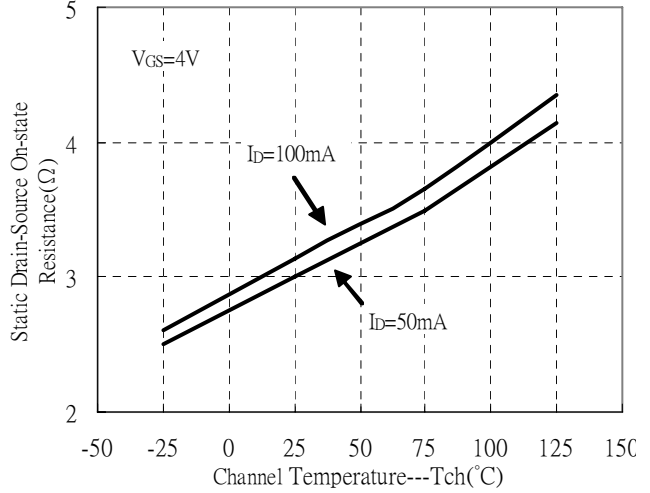

Static Drain-Source On-State resistance vs Drain Current

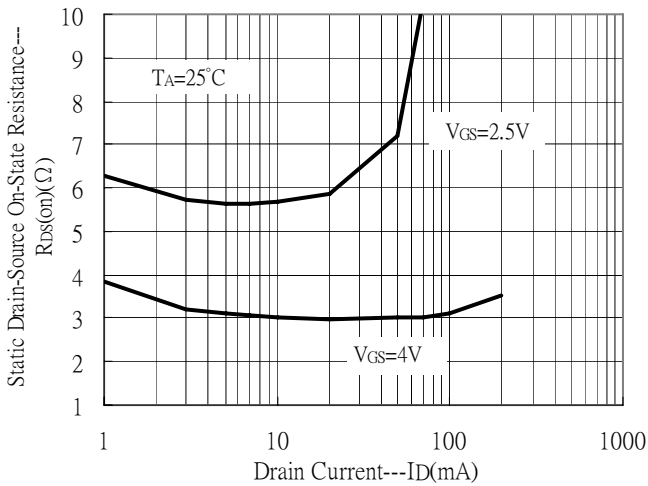

Static Drain-Source On-State resistance vs Drain Current

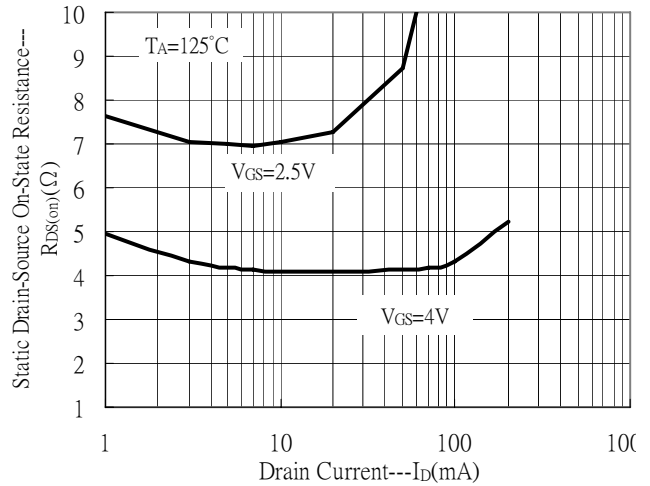



N-channel MOSFET Characteristic Curves(Cont.)

Static Drain-Source On-State Resistance vs Drain Current

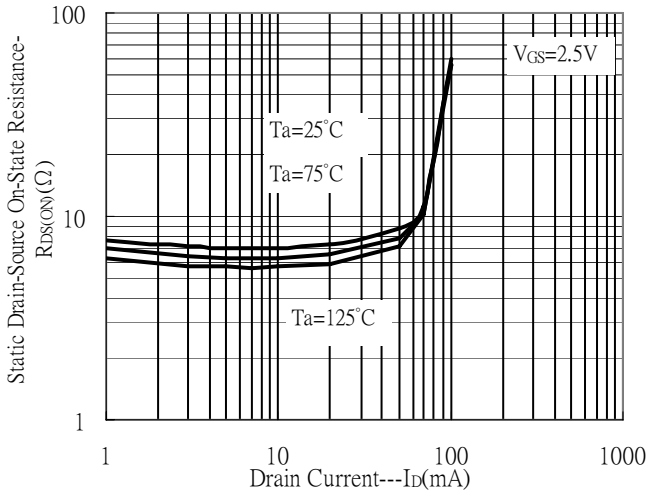

Static Drain-Source On-State Resistance vs Drain Current

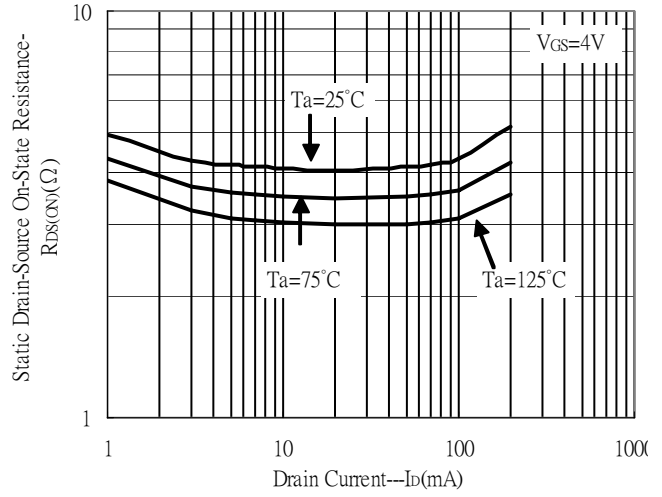

Static Drain-Source On-State Resistance vs Gate-Source Voltage

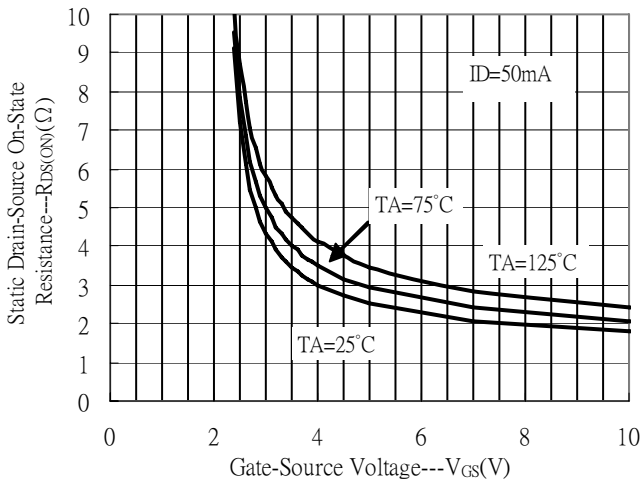

Static Drain-Source On-State Resistance vs Gate-Source Voltage

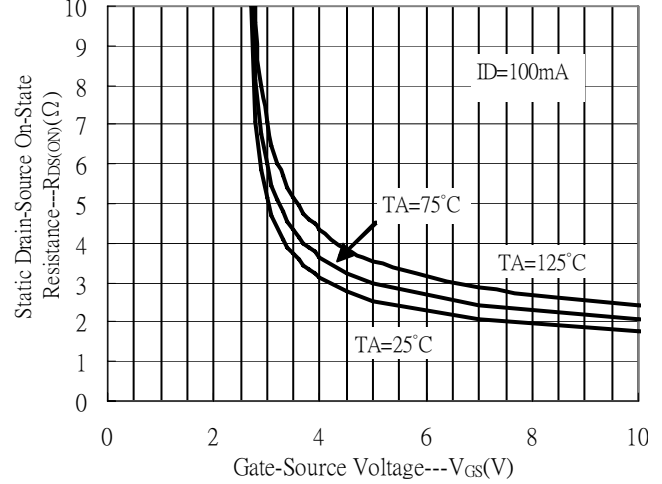

Reverse Drain Current vs Source-Drain Voltage(I)

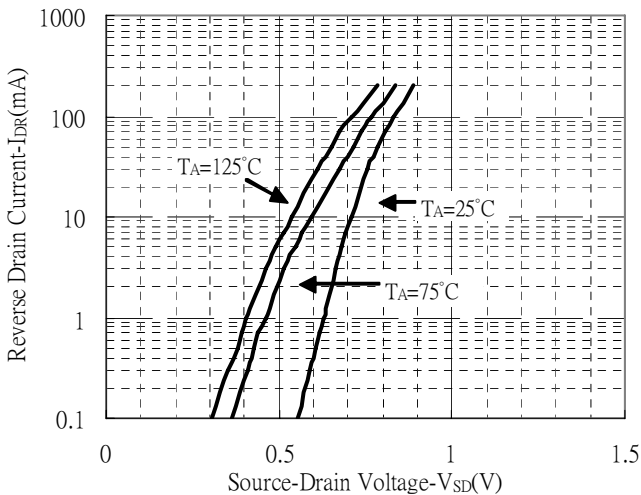

Reverse Drain Current vs Source-Drain Voltage(II)

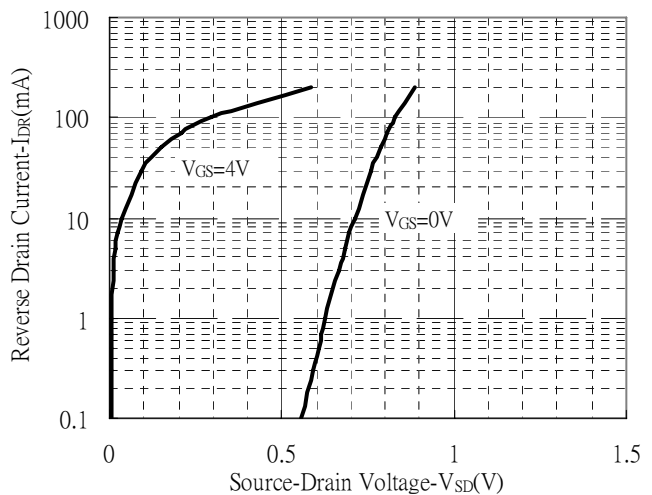



N-channel MOSFET Characteristic Curves(Cont.)

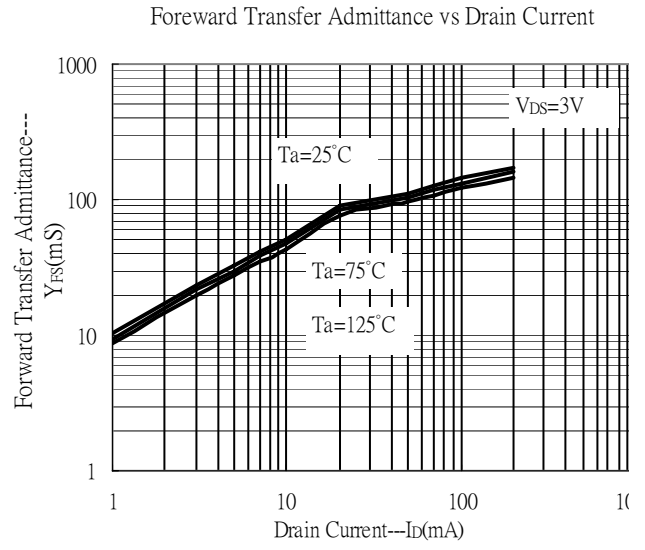
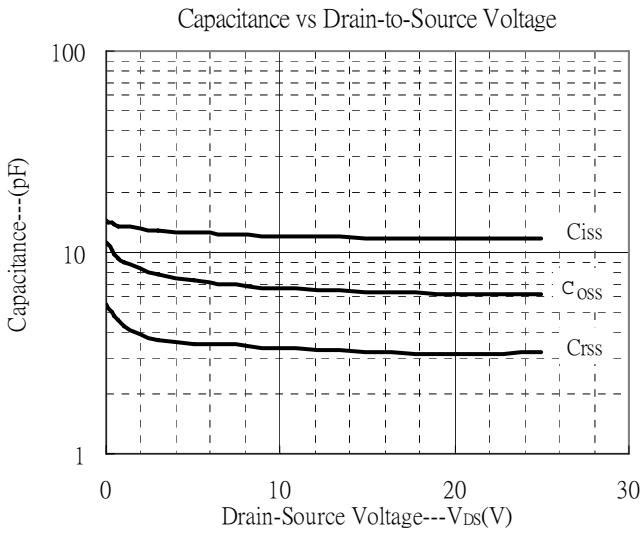

PNP BJT Characteristic Curves

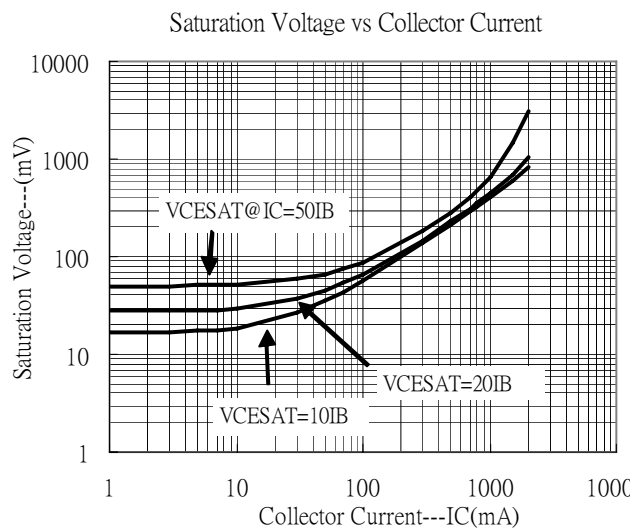
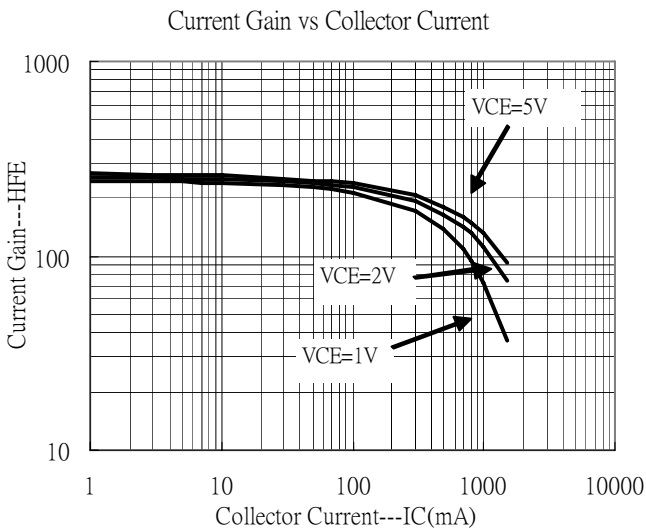
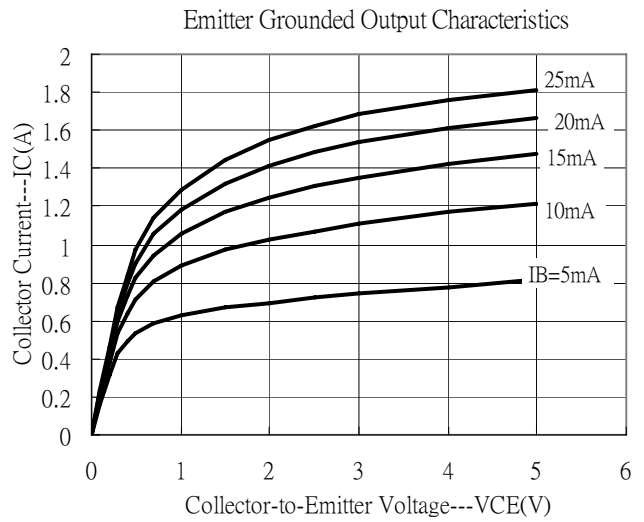
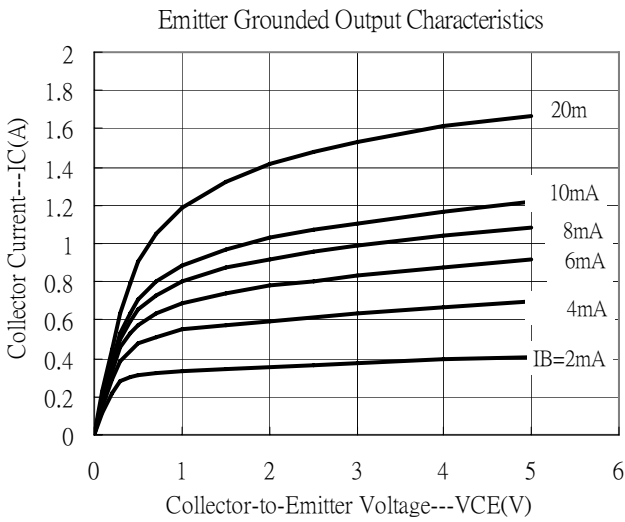
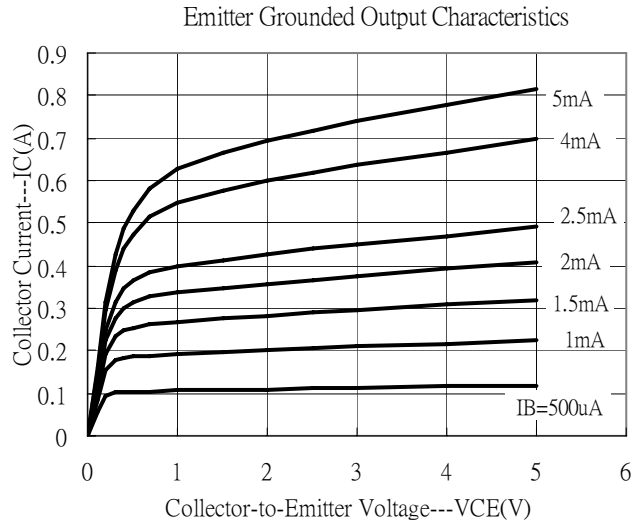
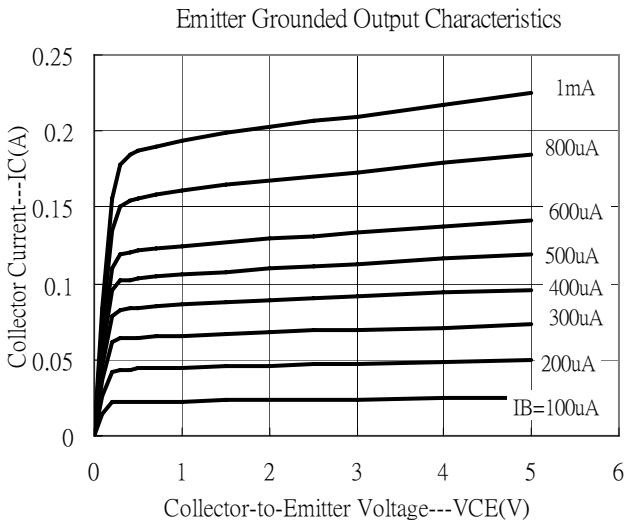



PNP BJT Characteristic Curves (Cont.)

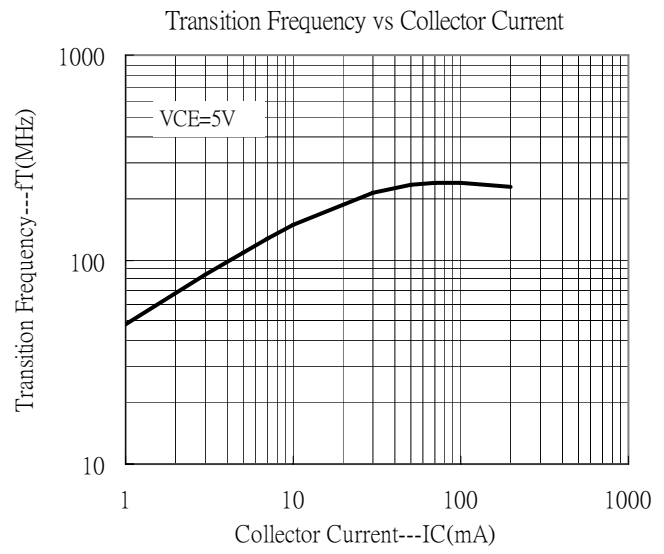
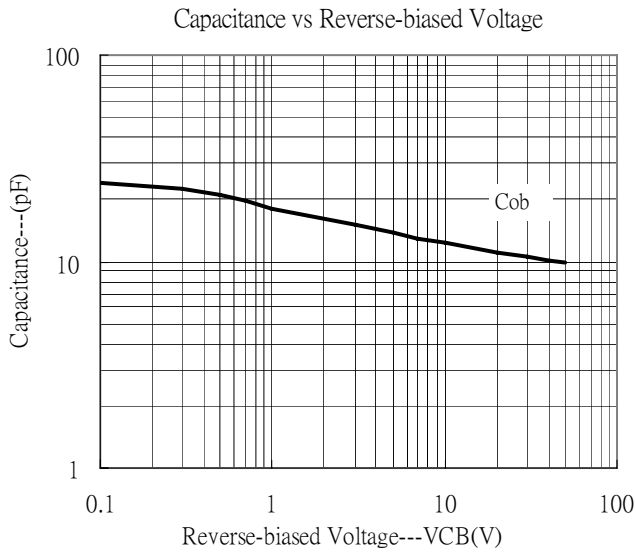
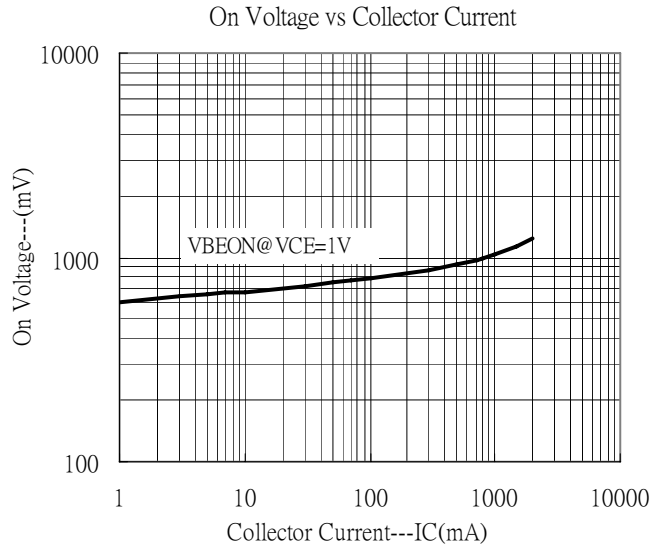
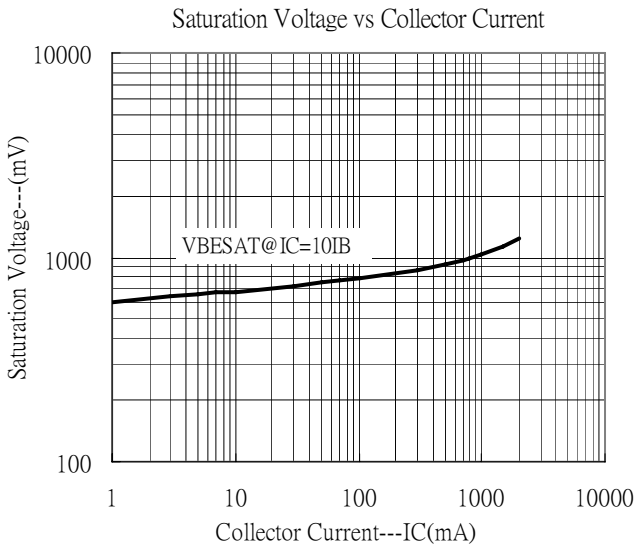

Recommended wave soldering condition

Product	Peak Temperature	Soldering Time
Pb-free devices	260 +0/-5 °C	5 +1/-1 seconds

Recommended temperature profile for IR reflow

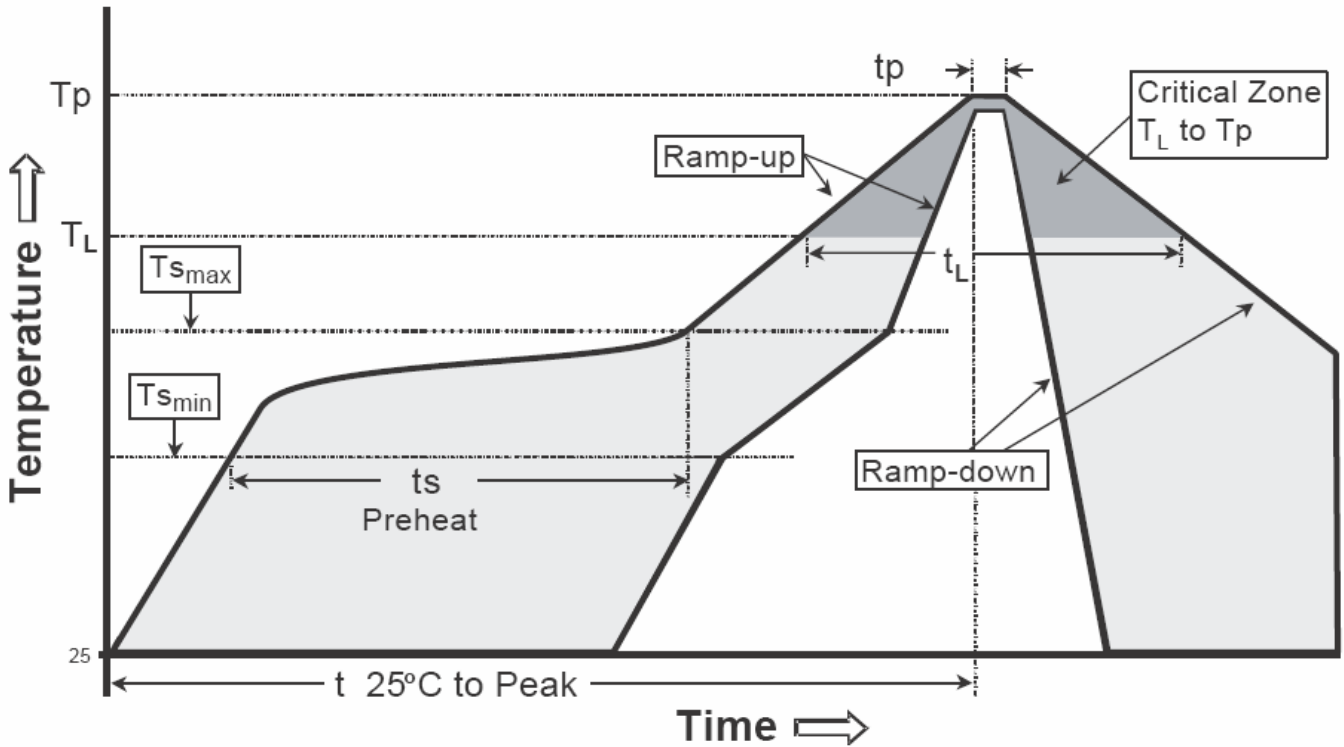

Profile feature	Sn-Pb eutectic Assembly	Pb-free Assembly
Average ramp-up rate (T _{smax} to T _p)	3°C/second max.	3°C/second max.
Preheat		
-Temperature Min(T _{s min})	100°C	150°C
-Temperature Max(T _{s max})	150°C	200°C
-Time(t _{s min} to t _{s max})	60-120 seconds	60-180 seconds
Time maintained above:		
-Temperature (T _L)	183°C	217°C
- Time (t _L)	60-150 seconds	60-150 seconds
Peak Temperature(T _P)	240 +0/-5 °C	260 +0/-5 °C
Time within 5°C of actual peak temperature(t _p)	10-30 seconds	20-40 seconds
Ramp down rate	6°C/second max.	6°C/second max.
Time 25 °C to peak temperature	6 minutes max.	8 minutes max.

Note : All temperatures refer to topside of the package, measured on the package body surface.

TSOP-6 Dimension

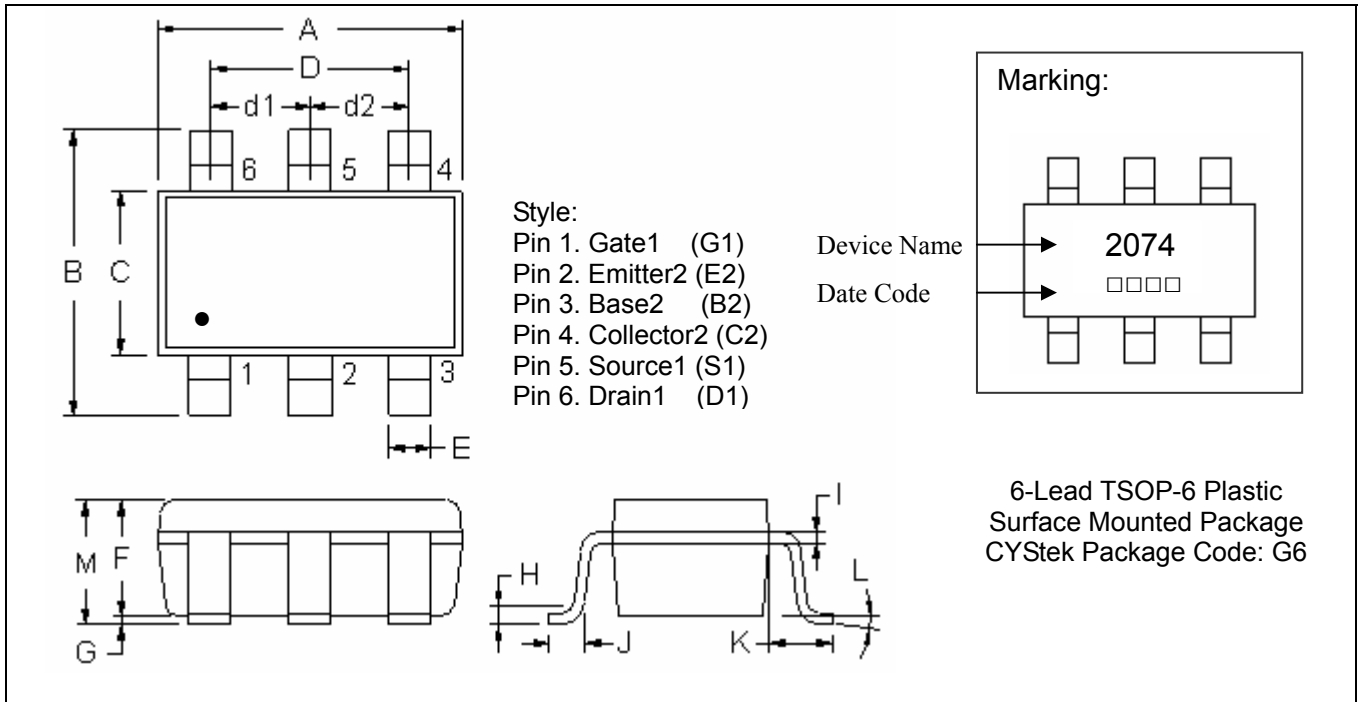

DIM	Inches		Millimeters		DIM	Inches		Millimeters	
	Min.	Max.	Min.	Max.		Min.	Max.	Min.	Max.
A	0.1063	0.1220	2.70	3.10	G	0	0.0039	0	0.10
B	0.1024	0.1181	2.60	3.00	H	-	0.0098	-	0.25
C	0.0551	0.0709	1.40	1.80	I	0.0047 REF		0.12 REF	
D	0.0748 REF		1.90 REF		J	0.0177 REF		0.45 REF	
d1	0.0374 REF		0.95 REF		K	0.0236 REF		0.60 REF	
d2	0.0374 REF		0.95 REF		L	0°	10°	0°	10°
E	0.0118	0.0197	0.30	0.50	M	-	0.0433	-	1.10
F	0.0276	0.0394	0.70	1.00					

Notes : 1.Controlling dimension : millimeters.
 2.Maximum lead thickness includes lead finish thickness, and minimum lead thickness is the minimum thickness of base material.
 3.If there is any question with packing specification or packing method, please contact your local CYStek sales office.

Material :

- Lead : Pure tin plated.
- Mold Compound : Epoxy resin family, flammability solid burning class:UL94V-0.

Important Notice:

- All rights are reserved. Reproduction in whole or in part is prohibited without the prior written approval of CYStek.
- CYStek reserves the right to make changes to its products without notice.
- CYStek **semiconductor products are not warranted to be suitable for use in Life-Support Applications, or systems.**
- CYStek assumes no liability for any consequence of customer product design, infringement of patents, or application assistance.