

**60V N-CHANNEL Enhancement Mode MOSFET**

# MTB090N06N3

BV <sub>DSS</sub>	60V
I <sub>D</sub>	3.9A
R <sub>DS(on)</sub> @V <sub>GS</sub> =10V, I <sub>D</sub> =3A	77mΩ (typ)
R <sub>DS(on)</sub> @V <sub>GS</sub> =4.5V, I <sub>D</sub> =2A	86mΩ (typ)

**Features**

- Simple drive requirement
- Small package outline
- Pb-free lead plating and halogen-free package

**Symbol**

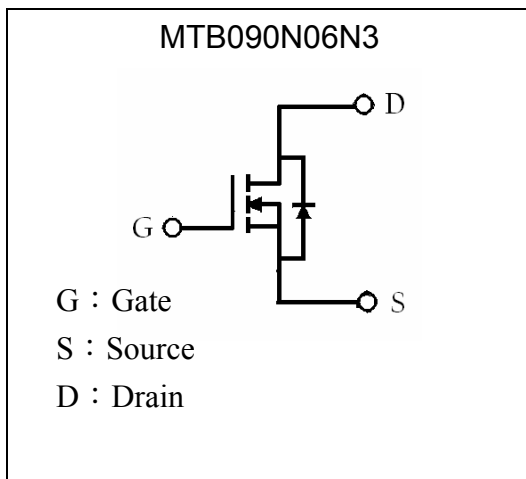

**Outline**

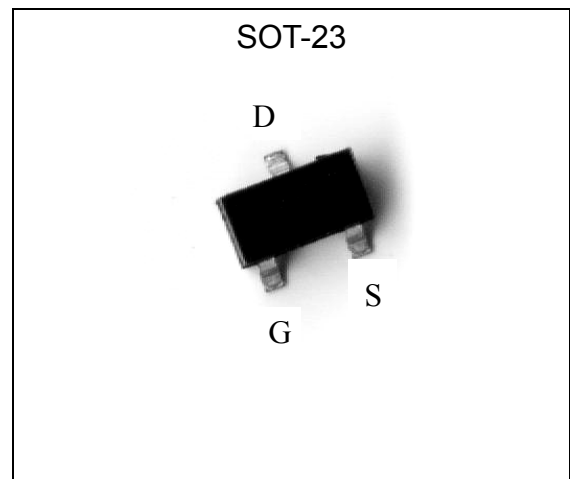

**Ordering Information**

Device	Package	Shipping
MTB090N06N3-0-T1-G	SOT-23 (Pb-free lead plating and halogen-free package)	3000 pcs / Tape & Reel

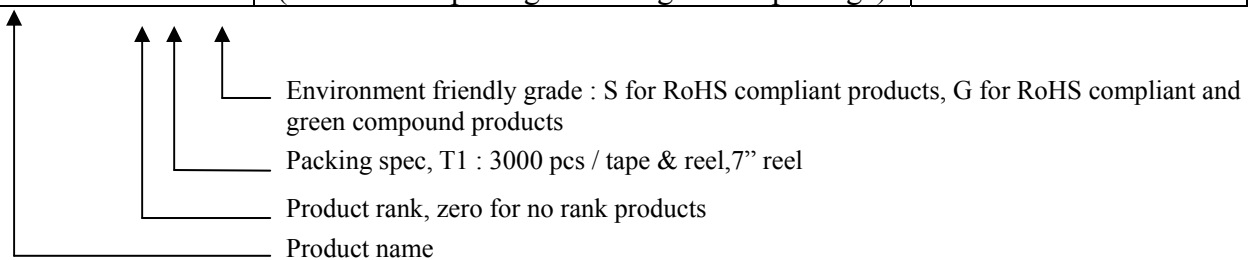



**Absolute Maximum Ratings (Ta=25°C)**

Parameter	Symbol	Limits	Unit
Drain-Source Voltage	V <sub>DS</sub>	60	V
Gate-Source Voltage	V <sub>GS</sub>	±20	
Continuous Drain Current @ TA=25°C, VGS=10V (Note 3)	I <sub>D</sub>	3.9	A
Continuous Drain Current @ TA=70°C, VGS=10V (Note 3)		3.1	
Pulsed Drain Current (Notes 1, 2)	I <sub>DM</sub>	16	
Maximum Power Dissipation@ TA=25°C (Note 3)	P <sub>D</sub>	1.25	W
Maximum Power Dissipation@ TA=70°C (Note 3)		0.8	
Operating Junction and Storage Temperature Range	T <sub>j</sub> ; T <sub>stg</sub>	-55~+150	°C

- Note : 1. Pulse width limited by maximum junction temperature.  
 2. Pulse width ≤ 300µs, duty cycle ≤ 2%.  
 3. Surface mounted on 1 in<sup>2</sup> copper pad of FR-4 board; 270°C/W when mounted on minimum copper pad

**Thermal Performance**

Parameter	Symbol	Limit	Unit
Thermal Resistance, Junction-to-Ambient, max	R <sub>θJA</sub>	100	°C/W
Thermal Resistance, Junction-to-Case, max	R <sub>θJC</sub>	70	°C/W

Note : Surface mounted on 1 in<sup>2</sup> copper pad of FR-4 board; 270°C/W when mounted on minimum copper pad

**Electrical Characteristics (Tj=25°C, unless otherwise noted)**

Symbol	Min.	Typ.	Max.	Unit	Test Conditions
<b>Static</b>					
BV <sub>DSS</sub>	60	-	-	V	V <sub>GS</sub> =0V, I <sub>D</sub> =250µA
V <sub>GS(th)</sub>	1.0	1.5	2.5	V	V <sub>DS</sub> =V <sub>GS</sub> , I <sub>D</sub> =250µA
I <sub>GSS</sub>	-	-	±100	nA	V <sub>GS</sub> =±20V, V <sub>DS</sub> =0V
I <sub>DSS</sub>	-	-	1	µA	V <sub>DS</sub> =48V, V <sub>GS</sub> =0V
	-	-	10		V <sub>DS</sub> =48V, V <sub>GS</sub> =0V (T <sub>j</sub> =85°C)
*R <sub>Ds(ON)</sub>	-	77	100	mΩ	I <sub>D</sub> =3A, V <sub>GS</sub> =10V
	-	86	115		I <sub>D</sub> =2A, V <sub>GS</sub> =4.5V
*G <sub>FS</sub>	-	2.3	-	S	V <sub>DS</sub> =15V, I <sub>D</sub> =1A
<b>Dynamic</b>					
C <sub>iss</sub>	-	504	-	pF	V <sub>DS</sub> =30V, V <sub>GS</sub> =0, f=1MHz
C <sub>oss</sub>	-	20	-		
C <sub>rss</sub>	-	18	-		
t <sub>d(ON)</sub>	-	5	-	ns	V <sub>DS</sub> =30V, I <sub>D</sub> =1A, V <sub>GS</sub> =10V, R <sub>G</sub> =1Ω
t <sub>r</sub>	-	3	-		
t <sub>d(OFF)</sub>	-	23	-		
t <sub>f</sub>	-	10	-		

Qg	-	6	-	nC	V <sub>DS</sub> =30V, I <sub>D</sub> =3.9A, V <sub>GS</sub> =10V
Qgs	-	1.7	-		
Qgd	-	1.6	-		
<b>Source-Drain Diode</b>					
*I <sub>S</sub>	-	-	3.9	A	
*I <sub>SM</sub>	-	-	16		
*V <sub>SD</sub>	-	0.8	1.2	V	V <sub>GS</sub> =0V, I <sub>F</sub> =2.3A

\*Pulse Test : Pulse Width ≤300μs, Duty Cycle≤2%

**Recommended Soldering Footprint**

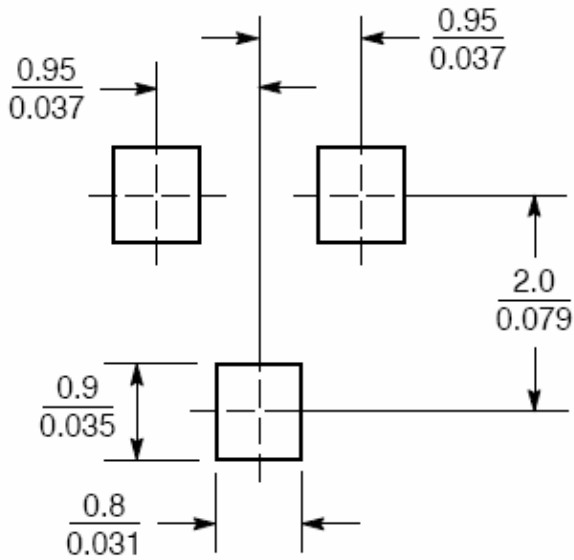

Unit :  $\frac{\text{mm}}{\text{inches}}$

## Typical Characteristics

Typical Output Characteristics

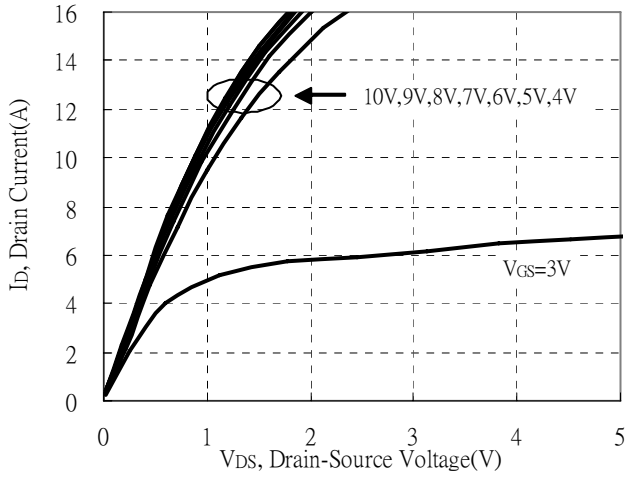

Brekdown Voltage vs Ambient Temperature

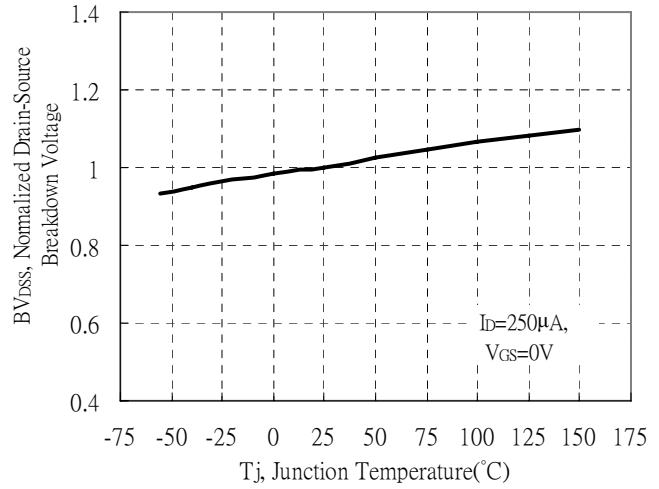

Static Drain-Source On-State resistance vs Drain Current

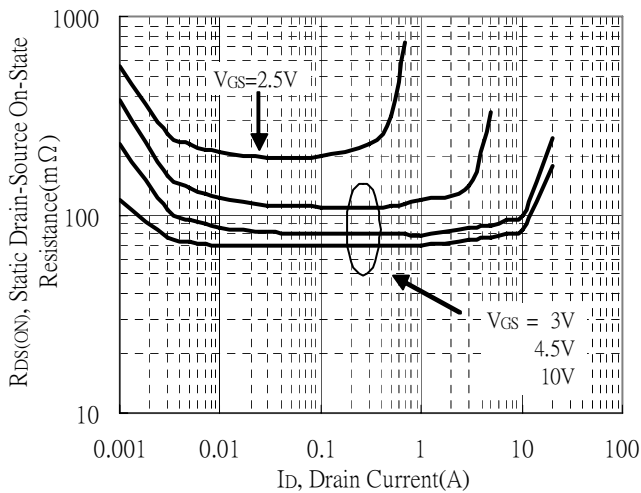

Reverse Drain Current vs Source-Drain Voltage

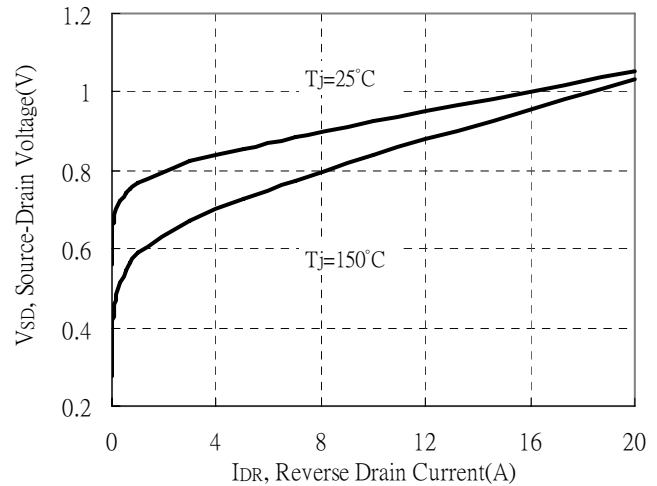

Static Drain-Source On-State Resistance vs Gate-Source Voltage

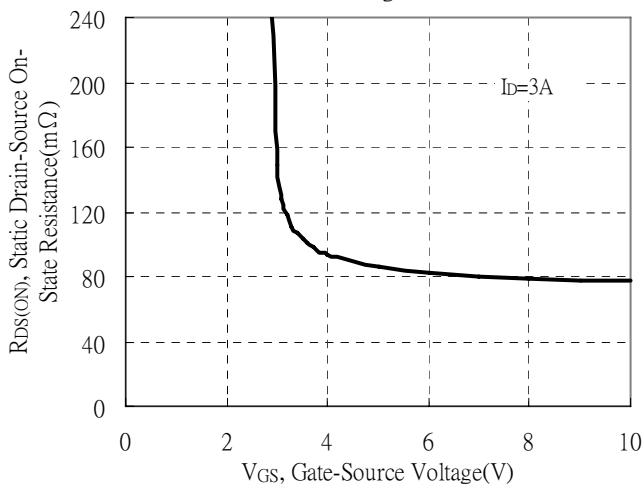

Drain-Source On-State Resistance vs Junction Temperature

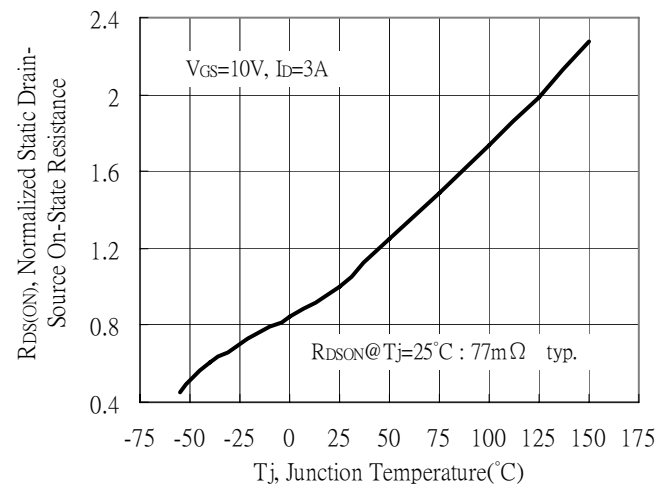

## Typical Characteristics(Cont.)

Capacitance vs Drain-to-Source Voltage

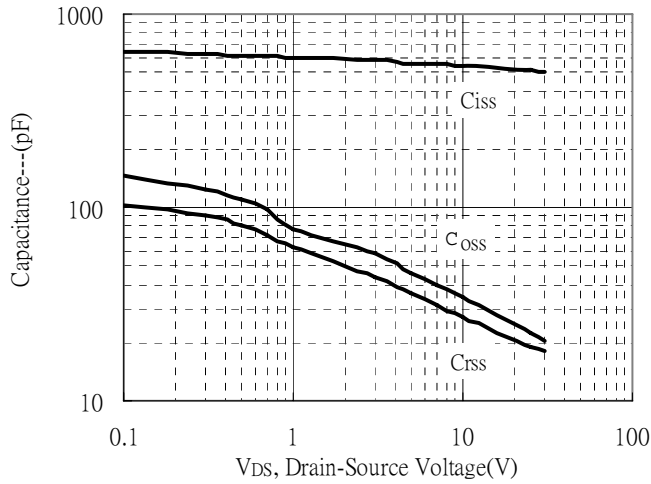

Threshold Voltage vs Junction Temperature

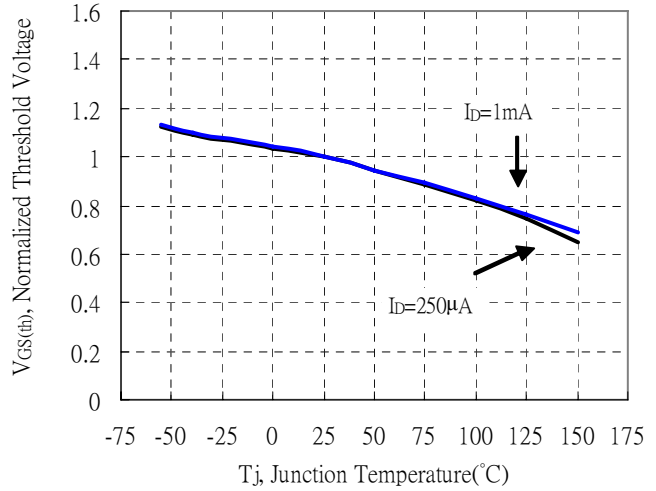

Forward Transfer Admittance vs Drain Current

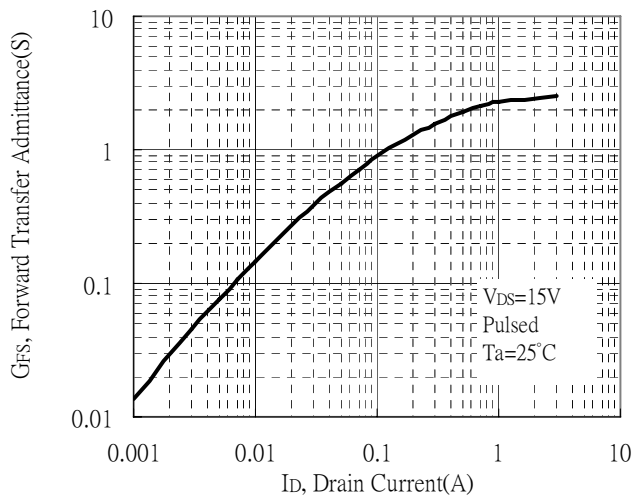

Gate Charge Characteristics

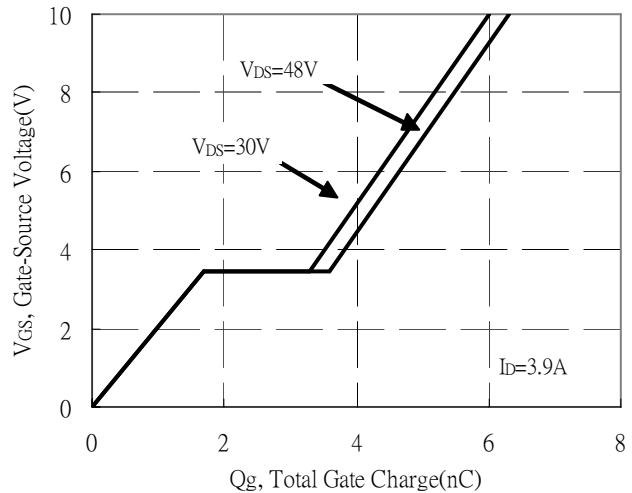

Maximum Safe Operating Area

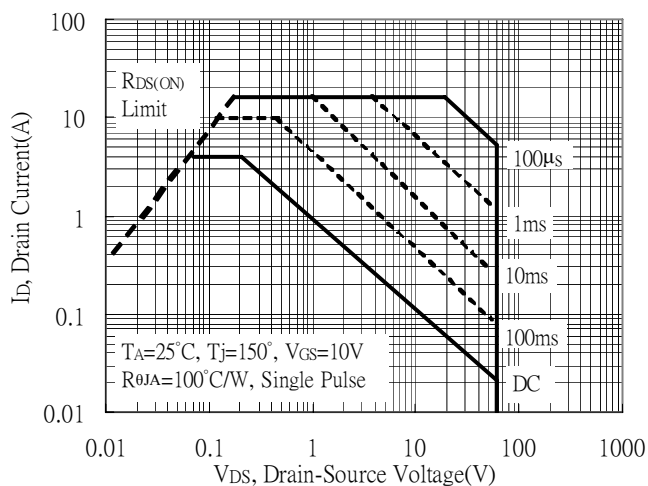

Maximum Drain Current vs Junction Temperature

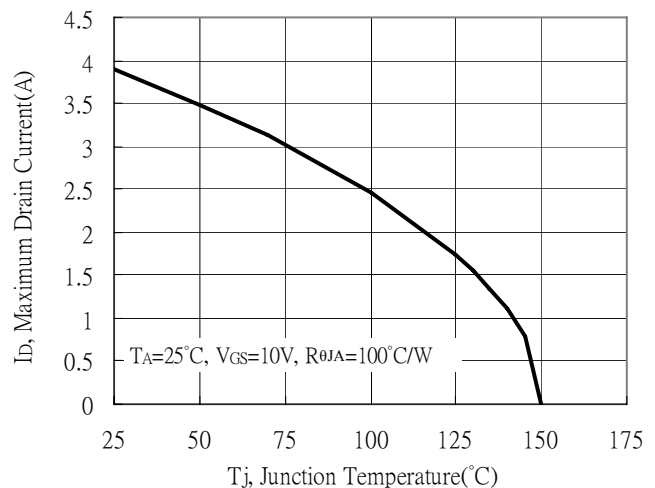

**Typical Characteristics(Cont.)**

Typical Transfer Characteristics

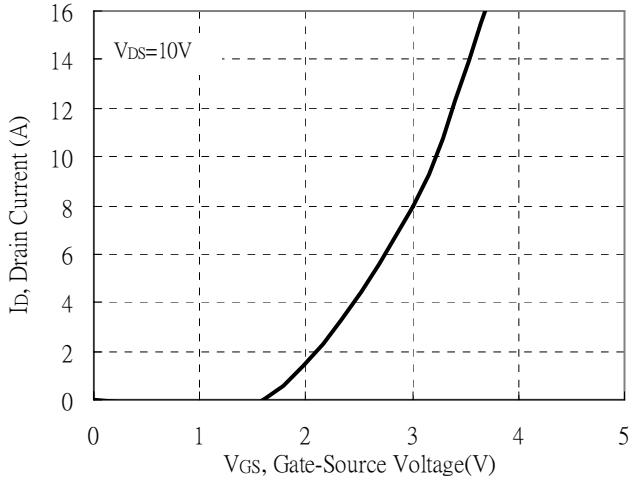

Single Pulse Power Rating, Junction to Ambient  
 (Note on page 2)

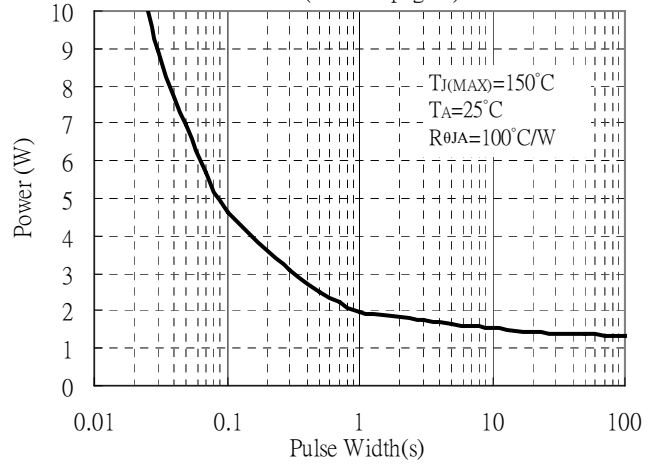

Transient Thermal Response Curves

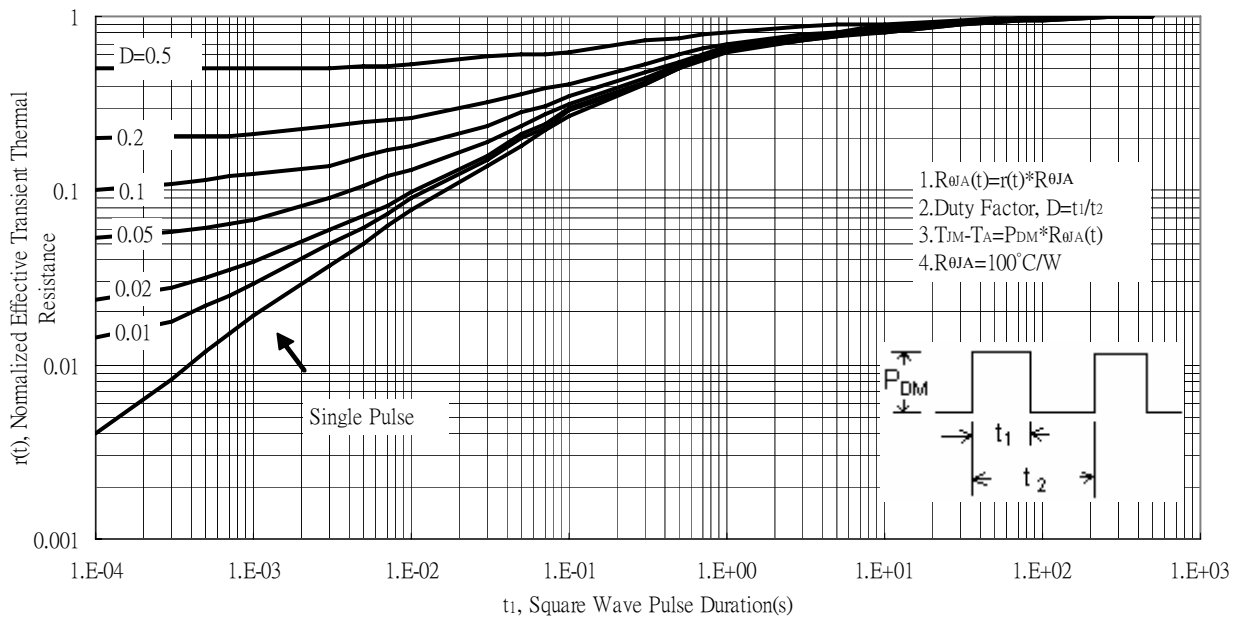

**Reel Dimension**

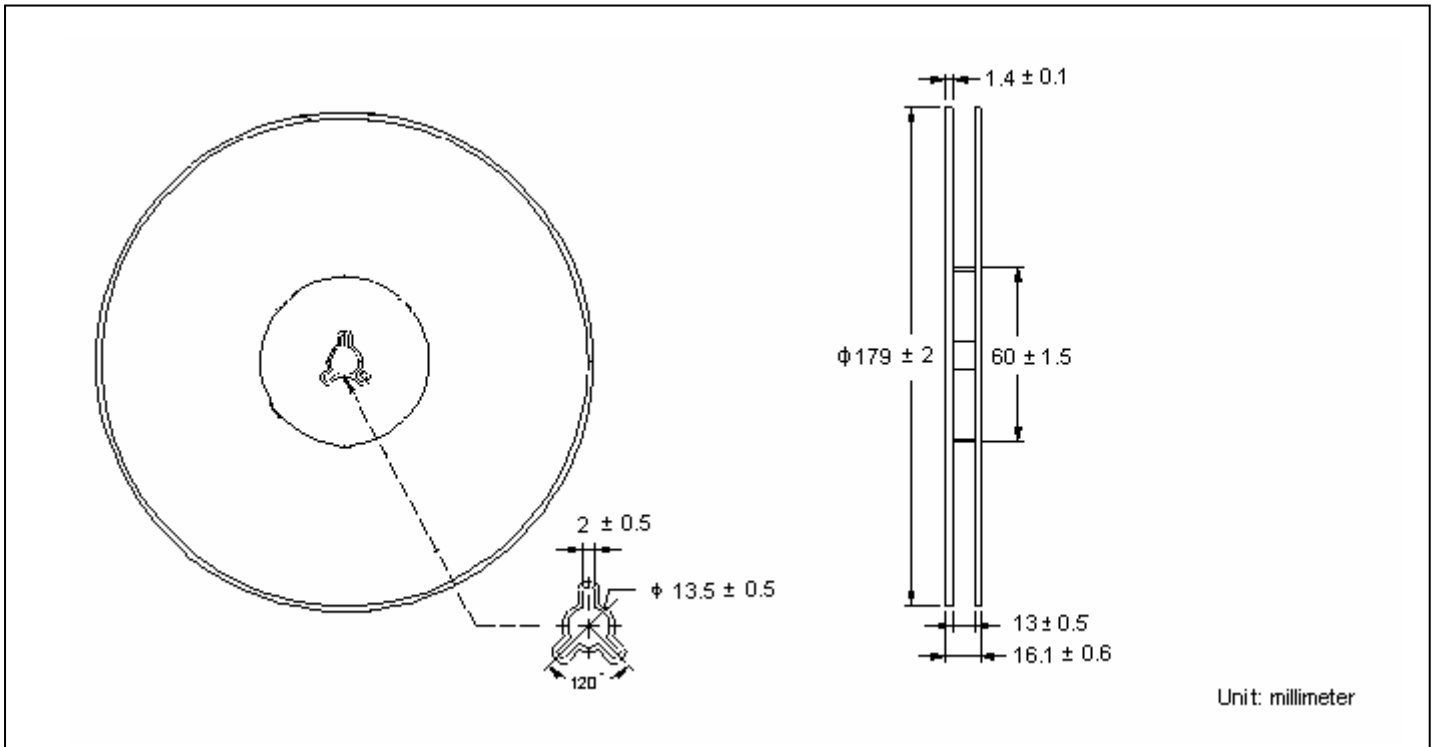

**Carrier Tape Dimension**

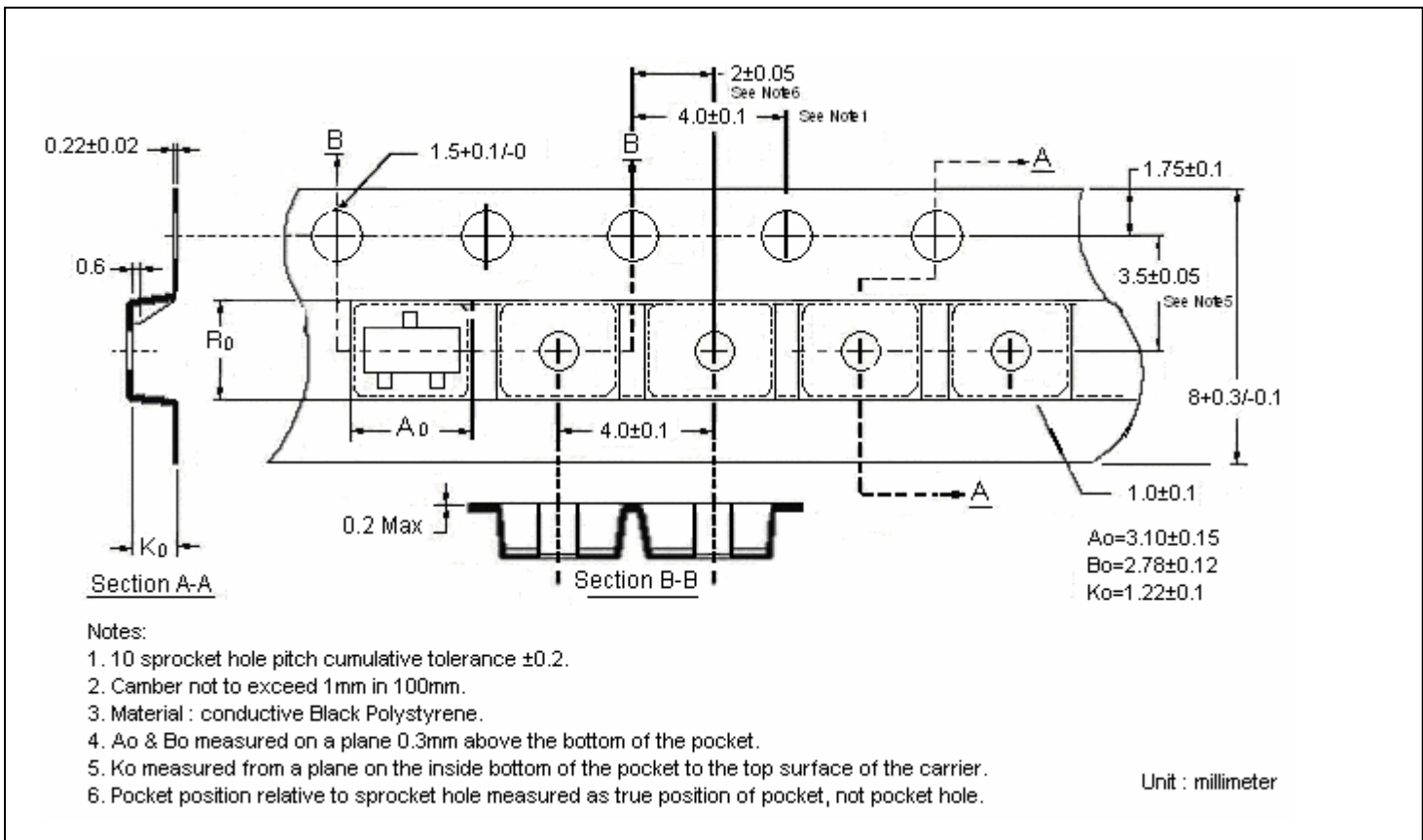

**Recommended wave soldering condition**

Product	Peak Temperature	Soldering Time
Pb-free devices	260 +0/-5 °C	5 +1/-1 seconds

**Recommended temperature profile for IR reflow**

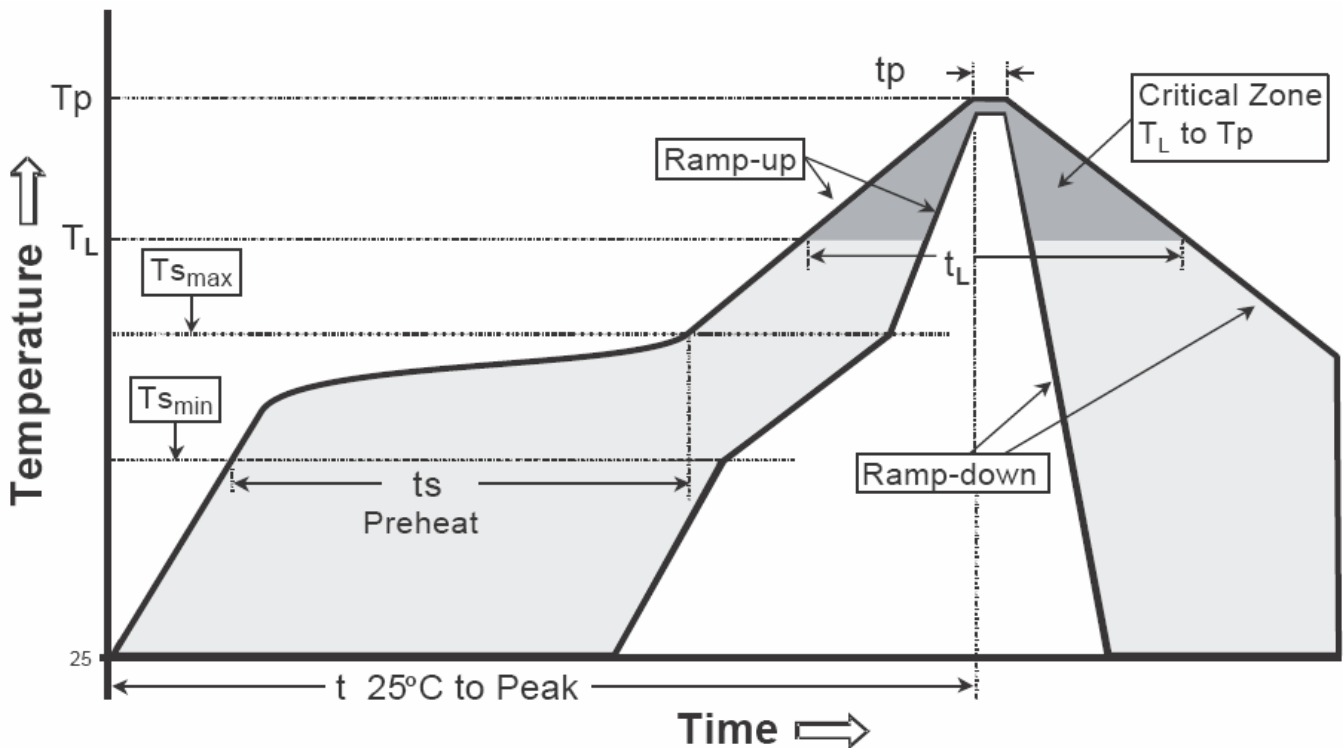

Profile feature	Sn-Pb eutectic Assembly	Pb-free Assembly
Average ramp-up rate (T <sub>smax</sub> to T <sub>p</sub> )	3°C/second max.	3°C/second max.
Preheat		
-Temperature Min(T <sub>s min</sub> )	100°C	150°C
-Temperature Max(T <sub>s max</sub> )	150°C	200°C
-Time(t <sub>s min</sub> to t <sub>s max</sub> )	60-120 seconds	60-180 seconds
Time maintained above:		
-Temperature (T <sub>L</sub> )	183°C	217°C
- Time (t <sub>L</sub> )	60-150 seconds	60-150 seconds
Peak Temperature(T <sub>P</sub> )	240 +0/-5 °C	260 +0/-5 °C
Time within 5°C of actual peak temperature(t <sub>p</sub> )	10-30 seconds	20-40 seconds
Ramp down rate	6°C/second max.	6°C/second max.
Time 25 °C to peak temperature	6 minutes max.	8 minutes max.

Note : All temperatures refer to topside of the package, measured on the package body surface.



**SOT-23 Dimension**

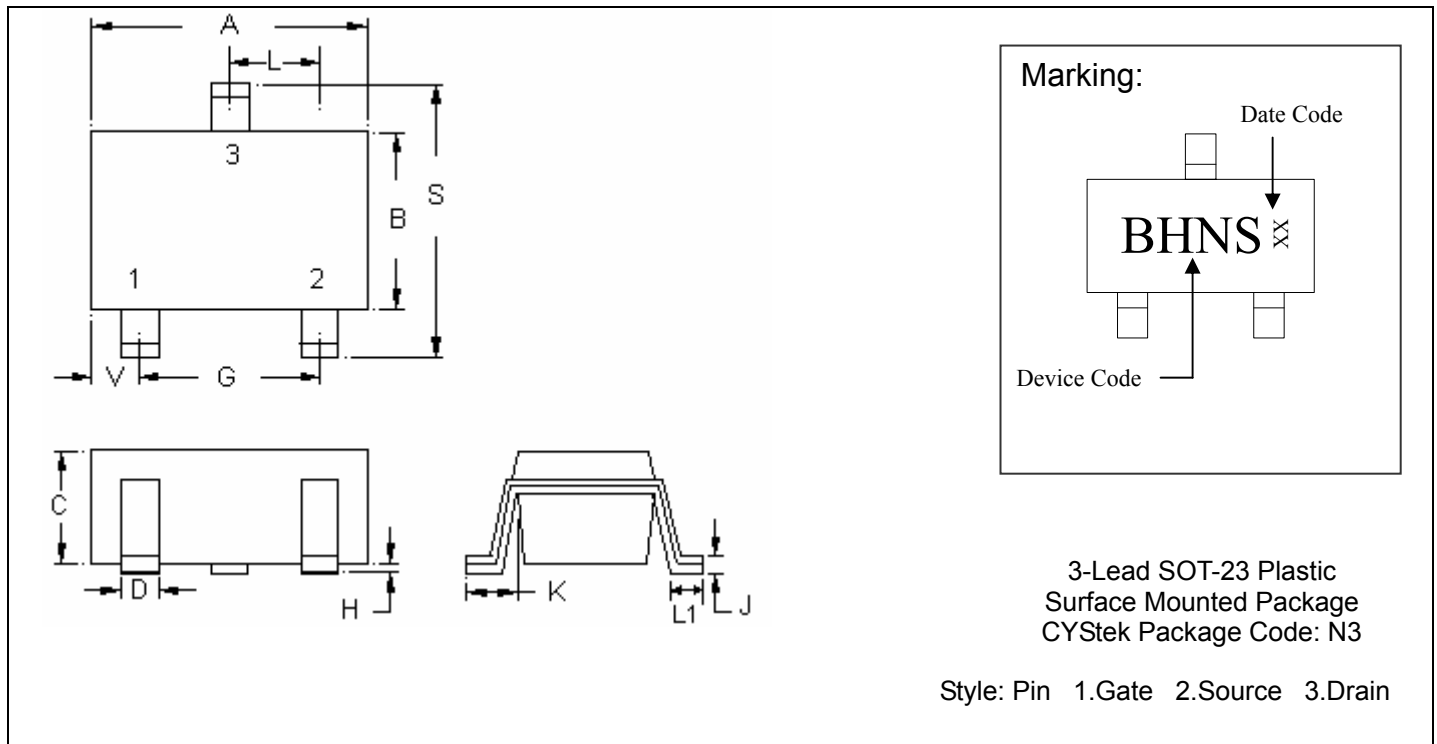

\*: Typical

DIM	Inches		Millimeters		DIM	Inches		Millimeters	
	Min.	Max.	Min.	Max.		Min.	Max.	Min.	Max.
A	0.1102	0.1204	2.80	3.04	J	0.0032	0.0079	0.08	0.20
B	0.0472	0.0669	1.20	1.70	K	0.0118	0.0266	0.30	0.67
C	0.0335	0.0512	0.89	1.30	L	0.0335	0.0453	0.85	1.15
D	0.0118	0.0197	0.30	0.50	S	0.0830	0.1161	2.10	2.95
G	0.0669	0.0910	1.70	2.30	V	0.0098	0.0256	0.25	0.65
H	0.0000	0.0040	0.00	0.10	L1	0.0118	0.0197	0.30	0.50

- Notes:**
- 1.Controlling dimension: millimeters.
  - 2.Maximum lead thickness includes lead finish thickness, and minimum lead thickness is the minimum thickness of base material.
  - 3.If there is any question with packing specification or packing method, please contact your local CYStek sales office.

**Material:**

- Lead: Pure tin plated.
- Mold Compound: Epoxy resin family, flammability solid burning class: UL94V-0.

**Important Notice:**

- All rights are reserved. Reproduction in whole or in part is prohibited without the prior written approval of CYStek.
- CYStek reserves the right to make changes to its products without notice.
- CYStek **semiconductor products are not warranted to be suitable for use in Life-Support Applications, or systems.**
- CYStek assumes no liability for any consequence of customer product design, infringement of patents, or application assistance.