

**N-Channel Enhancement Mode Power MOSFET**

# MTDA0N10L3

<b>BV<sub>DSS</sub></b>	<b>100V</b>
<b>I<sub>D</sub></b>	<b>3.9A</b>
<b>R<sub>DS(on)</sub>@V<sub>GS</sub>=10V, I<sub>D</sub>=3A</b>	<b>77mΩ (typ)</b>
<b>R<sub>DS(on)</sub>@V<sub>GS</sub>=5V, I<sub>D</sub>=2A</b>	<b>87mΩ (typ)</b>

**Description**

The MTDA0N10L3 is a N-channel enhancement-mode MOSFET, providing the designer with the best combination of fast switching, ruggedized device design, low on-resistance and cost effectiveness. The SOT-223 package is universally preferred for all commercial-industrial surface mount applications.

**Features**

- Single Drive Requirement
- Fast Switching Characteristic
- Pb-free lead plating and halogen-free package

**Symbol**

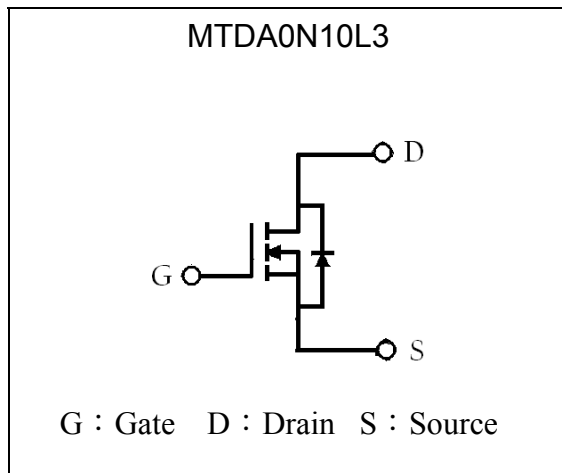

**Outline**

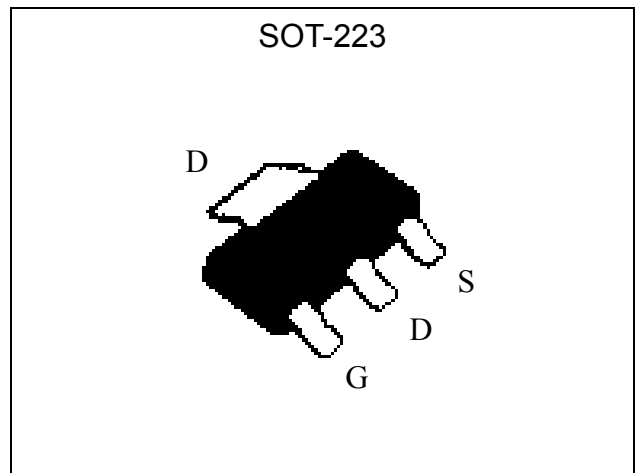

**Ordering Information**

Device	Package	Shipping
MTDA0N10L3-0-T3-G	SOT-223 (Pb-free lead plating and halogen-free package)	2500 pcs / tape & reel

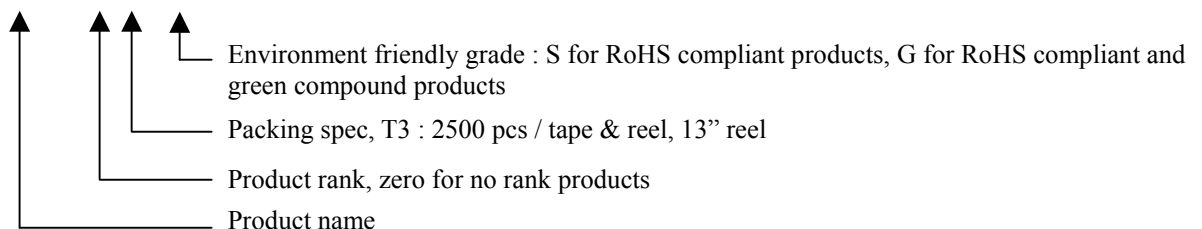



**Absolute Maximum Ratings** (Ta=25°C)

Parameter	Symbol	Limits	Unit	
Drain-Source Voltage	V <sub>DS</sub>	100	V	
Gate-Source Voltage	V <sub>GS</sub>	±20		
Continuous Drain Current @V <sub>GS</sub> =10V, T <sub>C</sub> =25°C	I <sub>D</sub>	7.0	A	
Continuous Drain Current @V <sub>GS</sub> =10V, T <sub>C</sub> =70°C		5.6		
Continuous Drain Current @V <sub>GS</sub> =10V, T <sub>A</sub> =25°C		3.9		
Continuous Drain Current @V <sub>GS</sub> =10V, T <sub>A</sub> =70°C		3.2		
Pulsed Drain Current	I <sub>DM</sub>	20 *1		
Total Power Dissipation	P <sub>D</sub>	T <sub>C</sub> =25°C	10	W
		T <sub>C</sub> =70°C	6.4	
		T <sub>A</sub> =25°C	3.1	
		T <sub>A</sub> =70°C	2.0	
Operating Junction and Storage Temperature Range	T <sub>j</sub> , T <sub>stg</sub>	-55~+150	°C	

**Thermal Data**

Parameter	Symbol	Value	Unit
Thermal Resistance, Junction-to-case, max	R <sub>th,j-c</sub>	12	°C/W
Thermal Resistance, Junction-to-ambient, max	R <sub>th,j-a</sub>	40 *3	°C/W

- Note : 1. Pulse width limited by maximum junction temperature  
 2. Duty cycle ≤ 1%  
 3. Surface mounted on 1 in<sup>2</sup> copper pad of FR-4 board, 120°C/W when mounted on minimum copper pad

**Characteristics (T<sub>C</sub>=25°C, unless otherwise specified)**

Symbol	Min.	Typ.	Max.	Unit	Test Conditions
<b>Static</b>					
BV <sub>DSS</sub>	100	-	-	V	V <sub>GS</sub> =0V, I <sub>D</sub> =250μA
ΔBV <sub>DSS</sub> /ΔT <sub>j</sub>	-	0.1	-	V/°C	Reference to 25°C, I <sub>D</sub> =250μA
V <sub>GS(th)</sub>	1.5	2.2	3.0	V	V <sub>DS</sub> = V <sub>GS</sub> , I <sub>D</sub> =250μA
ΔV <sub>GS(th)</sub> /ΔT <sub>j</sub>	-	-6	-	mV/°C	Reference to 25°C, I <sub>D</sub> =250μA
G <sub>FS</sub> *1	-	8	-	S	V <sub>DS</sub> =5V, I <sub>D</sub> =3A
I <sub>GSS</sub>	-	-	±100	nA	V <sub>GS</sub> =±20V
I <sub>DSS</sub>	-	-	1	μA	V <sub>DS</sub> =100V, V <sub>GS</sub> =0V
	-	-	25		V <sub>DS</sub> =100V, V <sub>GS</sub> =0V, T <sub>j</sub> =125°C
R <sub>DS(ON)</sub> *1	-	77	105	mΩ	V <sub>GS</sub> =10V, I <sub>D</sub> =3A
	-	87	120	mΩ	V <sub>GS</sub> =5V, I <sub>D</sub> =2A
<b>Dynamic</b>					
C <sub>iss</sub>	-	396	-	pF	V <sub>GS</sub> =0V, V <sub>DS</sub> =25V, f=1MHz
C <sub>oss</sub>	-	55	-		
C <sub>rss</sub>	-	23	-		

**Characteristics (Tc=25°C, unless otherwise specified)**

Symbol	Min.	Typ.	Max.	Unit	Test Conditions
Qg *1,2	-	11	-	nC	V <sub>DS</sub> =80V, V <sub>GS</sub> =10V, I <sub>D</sub> =3A
Qgs *1,2	-	1.5	-		
Qgd *1,2	-	3.5	-		
t <sub>d(ON)</sub> *1,2	-	8	-	ns	V <sub>DS</sub> =50V, I <sub>D</sub> =1A, V <sub>GS</sub> =10V, R <sub>GS</sub> =6Ω
t <sub>r</sub> *1,2	-	15	-		
t <sub>d(OFF)</sub> *1,2	-	15	-		
t <sub>f</sub> *1,2	-	7	-		
<b>Source-Drain Diode</b>					
I <sub>S</sub> *1	-	-	3.9	A	
I <sub>SM</sub> *3	-	-	20		
V <sub>SD</sub> *1	-	0.81	1.3	V	I <sub>S</sub> =3A, V <sub>GS</sub> =0V
t <sub>rr</sub>	-	30	-	ns	I <sub>F</sub> =3A, dI <sub>F</sub> /dt=100A/μs
Q <sub>rr</sub>	-	25	-	nC	

Note : \*1.Pulse Test : Pulse Width ≤300μs, Duty Cycle≤2%  
 \*2.Independent of operating temperature  
 \*3.Pulse width limited by maximum junction temperature.

**Recommended soldering footprint**

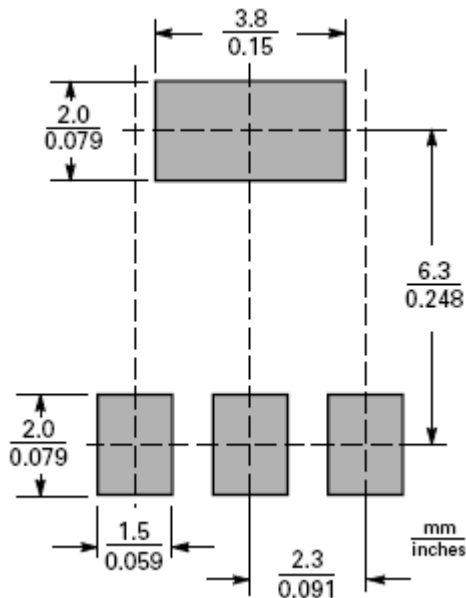

**Typical Characteristics**

Typical Output Characteristics

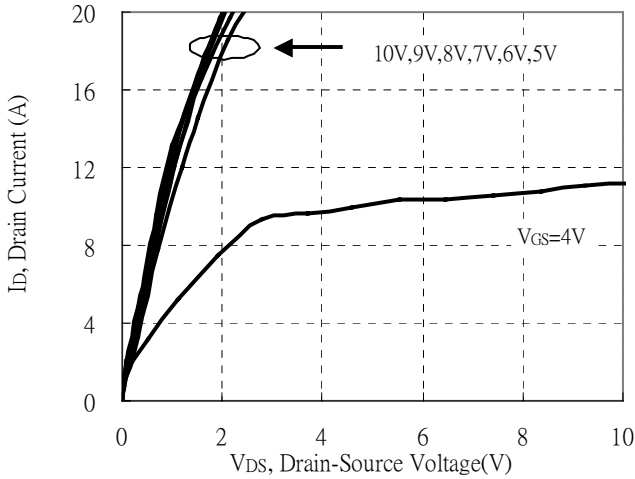

Brekdown Voltage vs Ambient Temperature

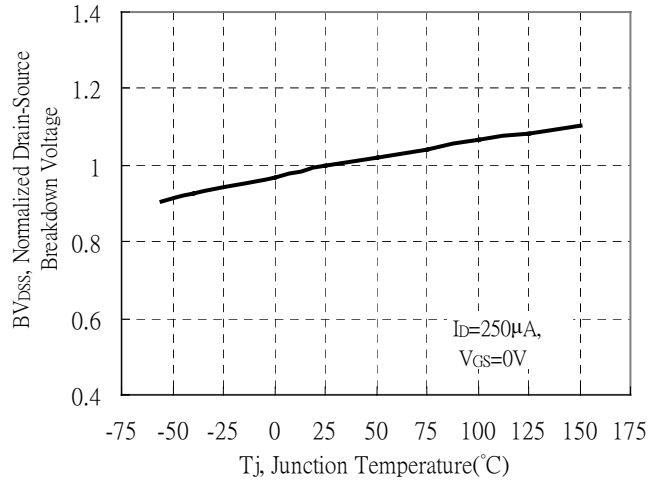

Static Drain-Source On-State resistance vs Drain Current

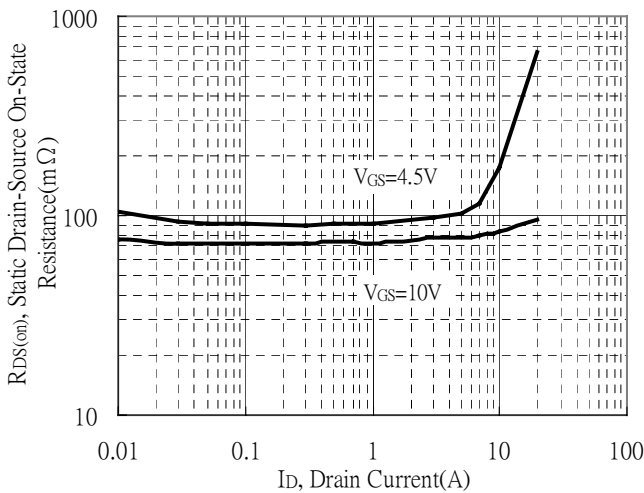

Reverse Drain Current vs Source-Drain Voltage

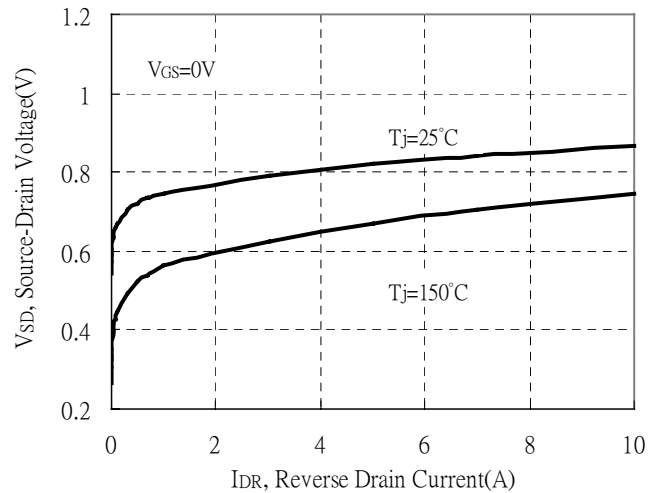

Static Drain-Source On-State Resistance vs Gate-Source Voltage

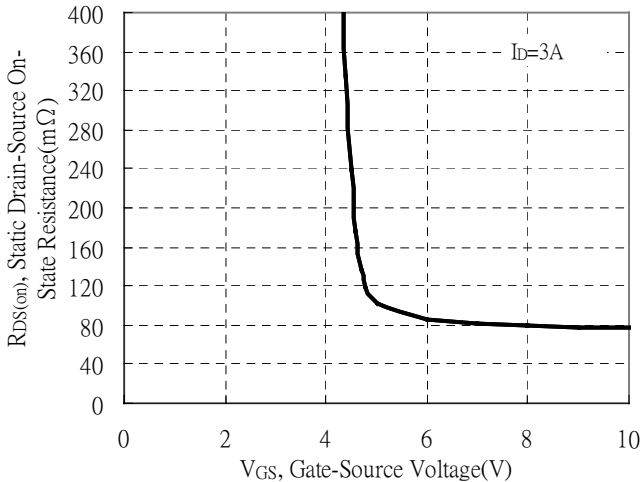

Drain-Source On-State Resistance vs Junction Temperature

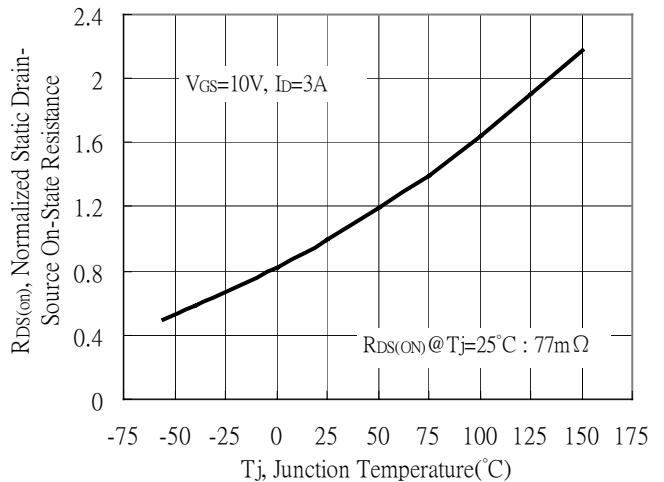



**Typical Characteristics(Cont.)**

Capacitance vs Drain-to-Source Voltage

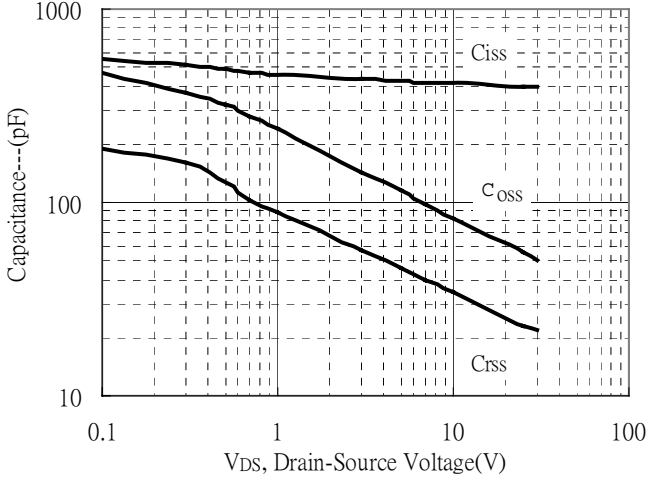

Threshold Voltage vs Junction Temperature

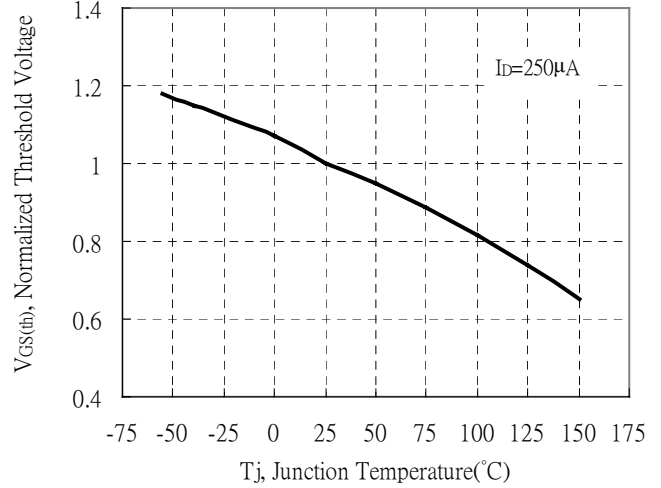

Forward Transfer Admittance vs Drain Current

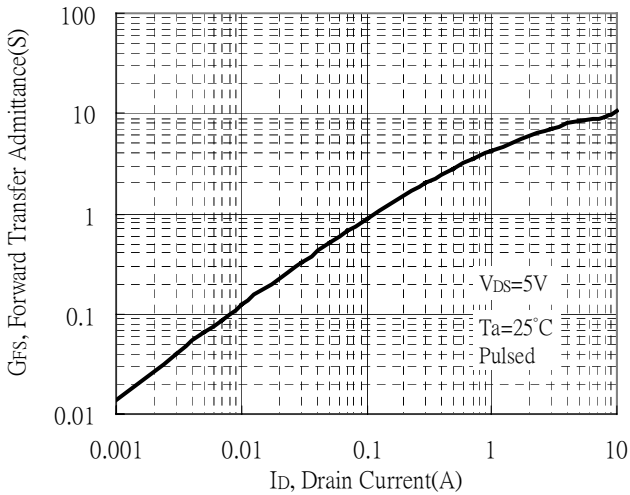

Gate Charge Characteristics

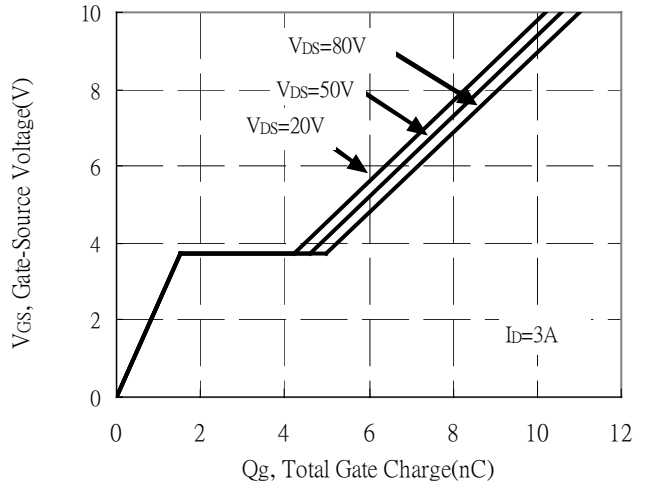

Maximum Safe Operating Area

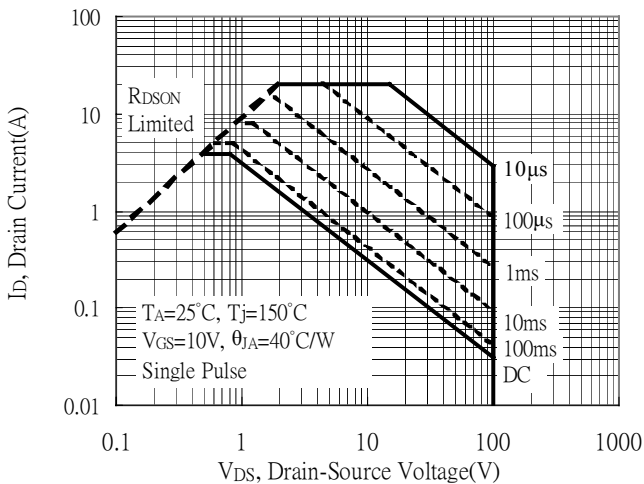

Maximum Drain Current vs Junction Temperature

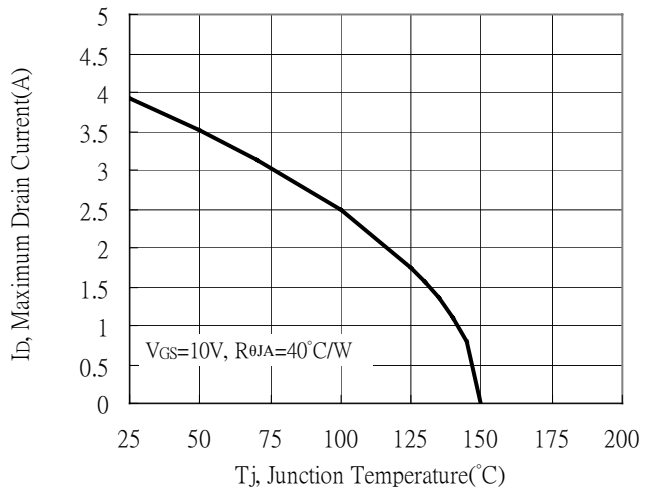



**Typical Characteristics(Cont.)**

Typical Transfer Characteristics

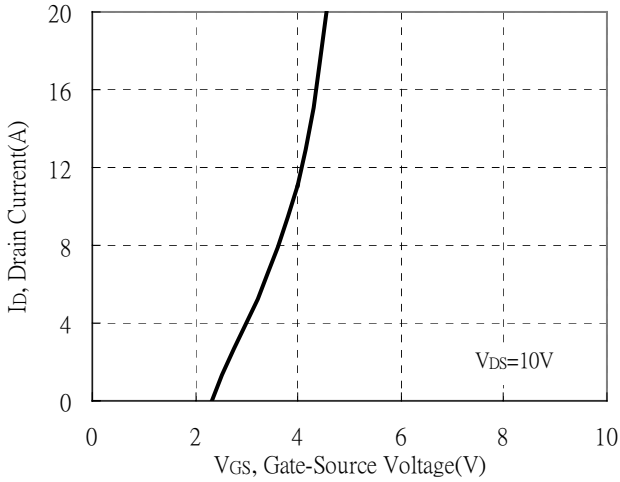

Single Pulse Maximum Power Dissipation

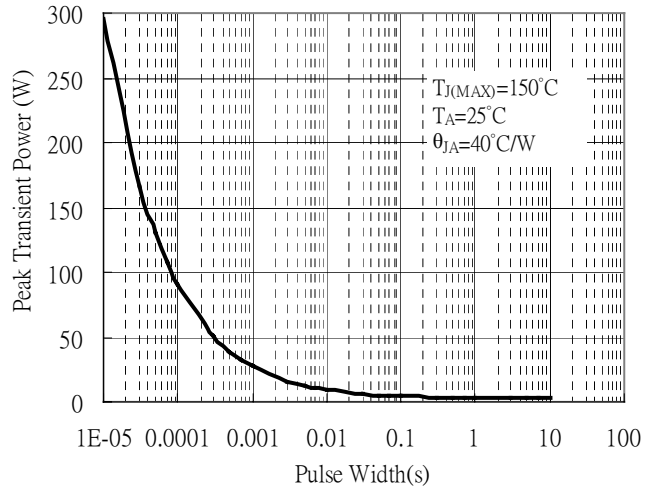

Transient Thermal Response Curves

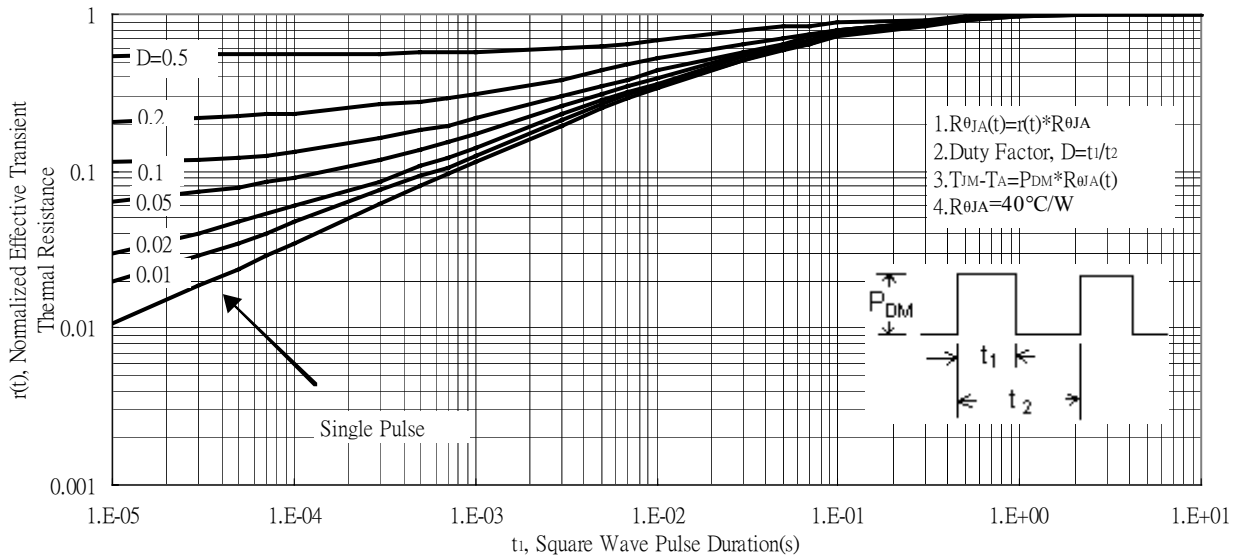

**Reel Dimension**

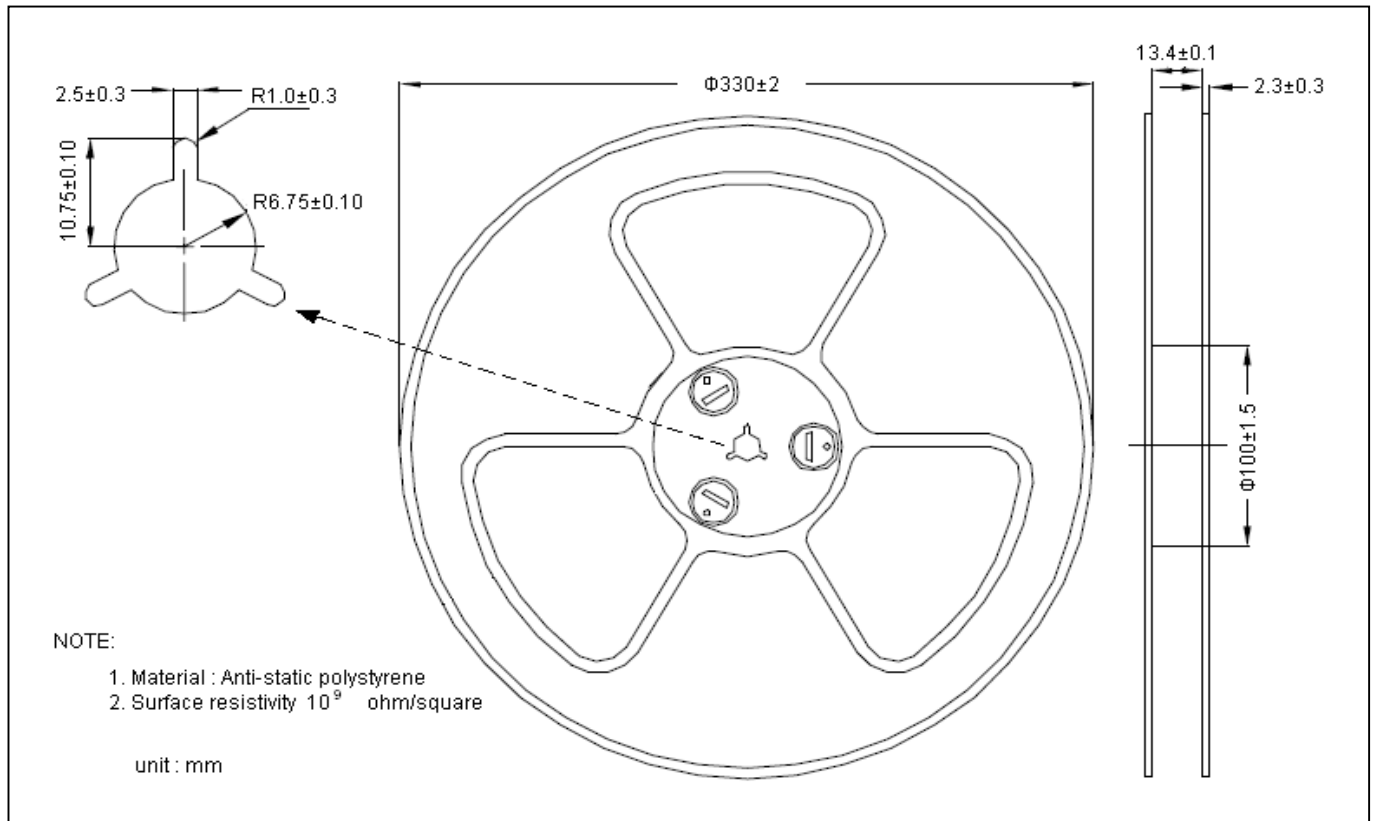

**Carrier Tape Dimension**

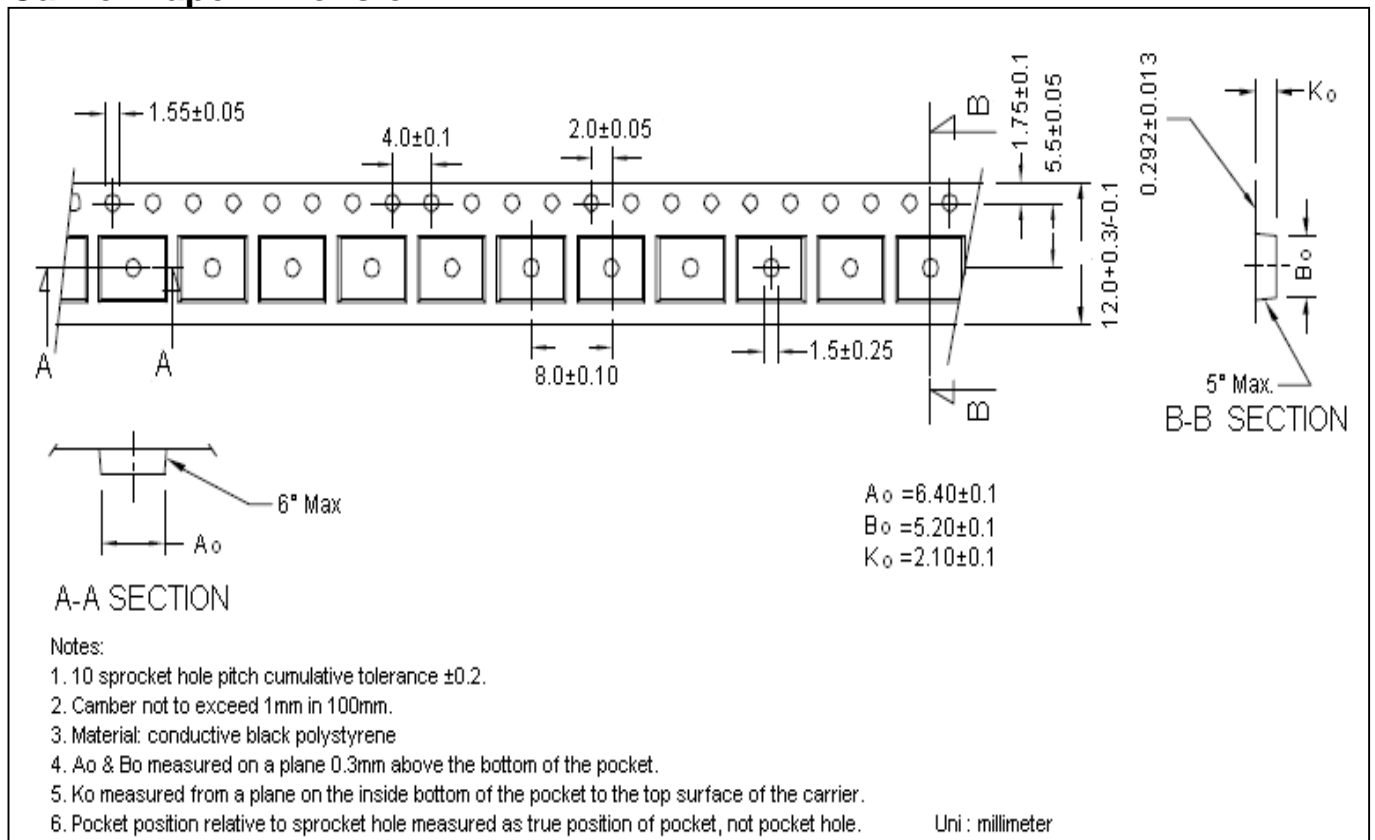

**Recommended wave soldering condition**

Product	Peak Temperature	Soldering Time
Pb-free devices	260 +0/-5 °C	5 +1/-1 seconds

**Recommended temperature profile for IR reflow**

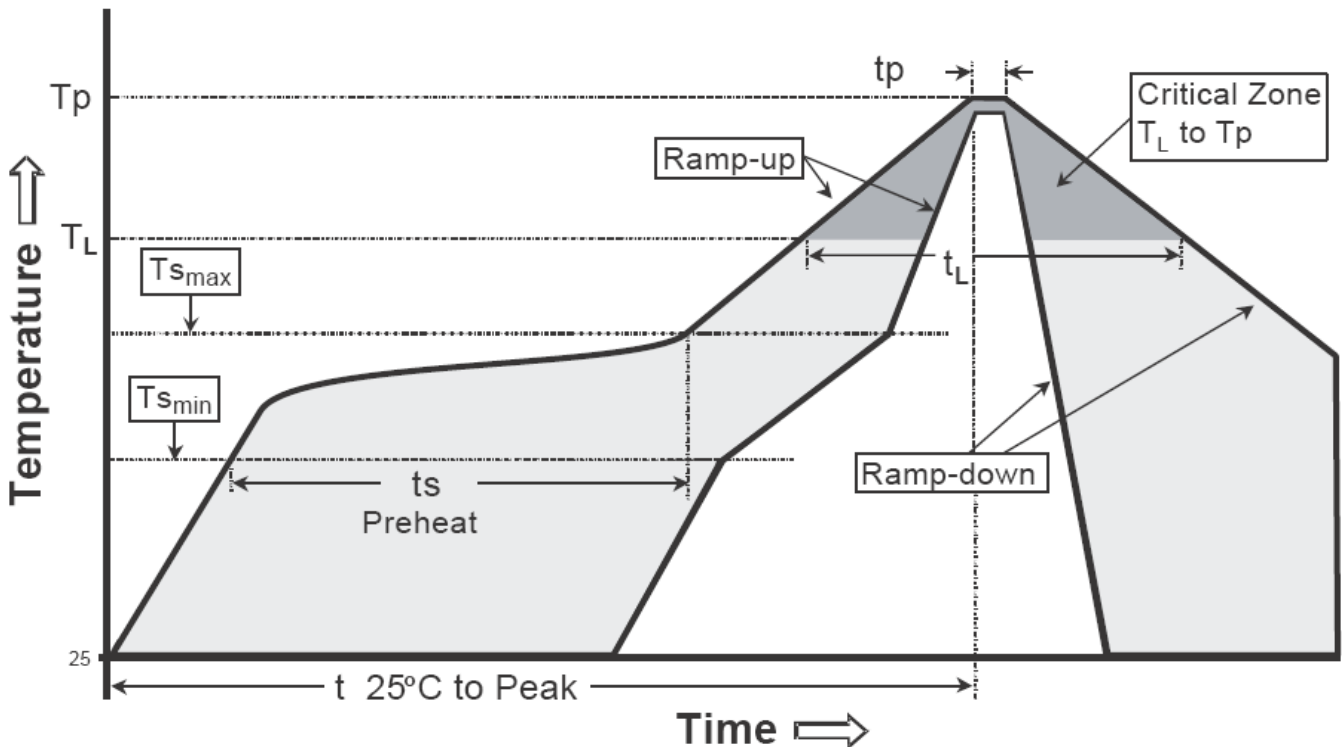

Profile feature	Sn-Pb eutectic Assembly	Pb-free Assembly
Average ramp-up rate (Tsmax to Tp)	3°C/second max.	3°C/second max.
Preheat		
-Temperature Min(Ts min)	100°C	150°C
-Temperature Max(Ts max)	150°C	200°C
-Time(ts min to ts max)	60-120 seconds	60-180 seconds
Time maintained above:		
-Temperature (Tl)	183°C	217°C
- Time (tL)	60-150 seconds	60-150 seconds
Peak Temperature(Tp)	240 +0/-5 °C	260 +0/-5 °C
Time within 5°C of actual peak temperature(tp)	10-30 seconds	20-40 seconds
Ramp down rate	6°C/second max.	6°C/second max.
Time 25 °C to peak temperature	6 minutes max.	8 minutes max.

Note : All temperatures refer to topside of the package, measured on the package body surface.



**SOT-223 Dimension**

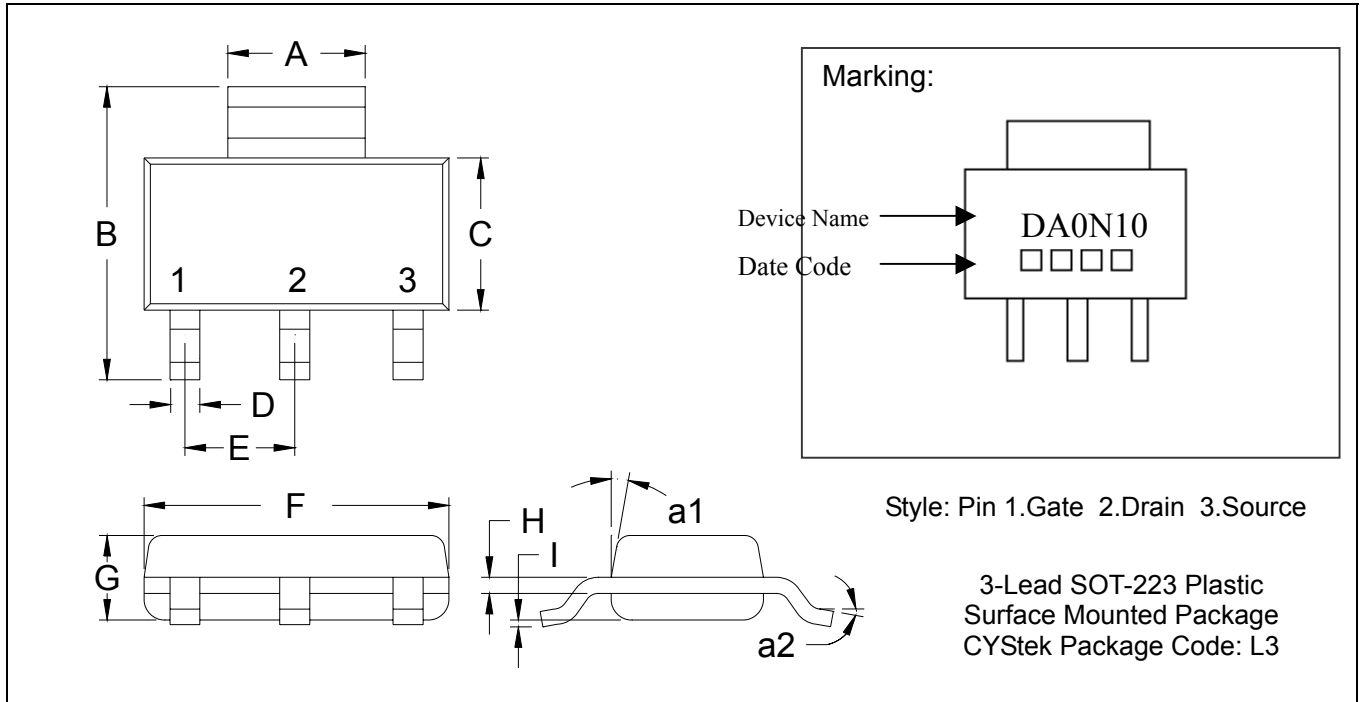

\*: Typical

DIM	Inches		Millimeters		DIM	Inches		Millimeters	
	Min.	Max.	Min.	Max.		Min.	Max.	Min.	Max.
A	0.1142	0.1220	2.90	3.10	G	0.0551	0.0709	1.40	1.80
B	0.2638	0.2874	6.70	7.30	H	0.0098	0.0138	0.25	0.35
C	0.1299	0.1457	3.30	3.70	I	0.0008	0.0039	0.02	0.10
D	0.0236	0.0315	0.60	0.80	a1	*13°	-	*13°	-
E	*0.0906	-	*2.30	-	a2	0°	10°	0°	10°
F	0.2480	0.2638	6.30	6.70					

- Notes: 1.Controlling dimension: millimeters.  
 2.Maximum lead thickness includes lead finish thickness, and minimum lead thickness is the minimum thickness of base material.  
 3.If there is any question with packing specification or packing method, please contact your local CYStek sales office.

**Material:**

- Lead: Pure tin plated.
- Mold Compound: Epoxy resin family, flammability solid burning class: UL94V-0.

**Important Notice:**

- All rights are reserved. Reproduction in whole or in part is prohibited without the prior written approval of CYStek.
- CYStek reserves the right to make changes to its products without notice.
- CYStek **semiconductor products are not warranted to be suitable for use in Life-Support Applications, or systems.**
- CYStek assumes no liability for any consequence of customer product design, infringement of patents, or application assistance.