

N- AND P-Channel Enhancement Mode MOSFET

MTC1421G6

| | N-CH (Q1) | P-CH (Q2) |
|--------------------------|------------------------------|-------------------------------|
| BV _{DSS} | 20V | -20V |
| I _D | 2A(V _{GS} =4.5V) | -1.5A(V _{GS} =-4.5V) |
| R _{DSON} (TYP.) | 73mΩ(V _{GS} =4.5V) | 170mΩ(V _{GS} =-4.5V) |
| | 92mΩ(V _{GS} =2.5V) | 224mΩ(V _{GS} =-2.5V) |
| | 147mΩ(V _{GS} =1.8V) | 340mΩ(V _{GS} =-1.8V) |

Features

- Simple drive requirement
- Low gate charge
- Low on-resistance
- Fast switching speed
- ESD protected
- Pb-free lead plating and halogen-free package

Equivalent Circuit

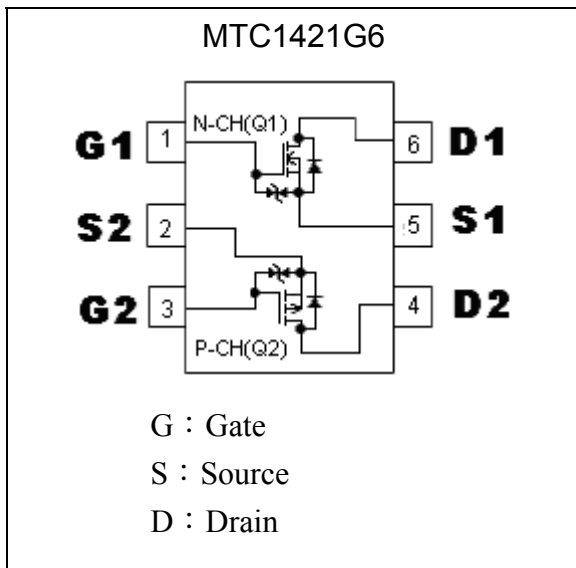

Outline

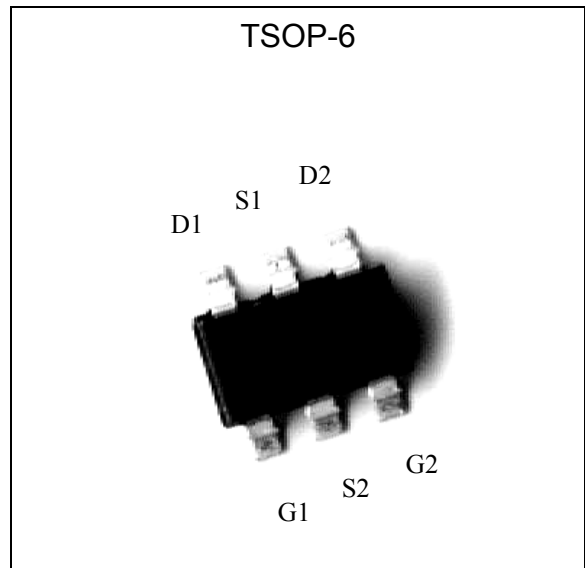

Ordering Information

| Device | Package | Shipping |
|------------------|---|------------------------|
| MTC1421G6-0-T1-G | TSOP-6 (Pb-free lead plating and halogen-free package) | 3000 pcs / Tape & Reel |

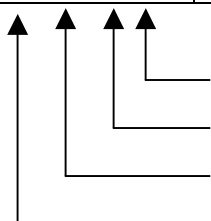

Environment friendly grade : S for RoHS compliant products, G for RoHS compliant and green compound products
 Packing spec, T1 : 3000 pcs / tape & reel, 7" reel
 Product rank, zero for no rank products
 Product name



Absolute Maximum Ratings (Ta=25°C)

| Parameter | | Symbol | Limits | | Unit |
|--|--|-----------------------------------|-----------|-----------|------|
| | | | N-channel | P-channel | |
| Drain-Source Breakdown Voltage | | BV _{DSS} | 20 | -20 | V |
| Gate-Source Voltage | | V _{GS} | ±8 | ±8 | V |
| Continuous Drain Current (Note 1) | T _A =25°C, V _{GS} =4.5V(N-CH), V _{GS} =-4.5V(P-CH) | I _D | 2 | -1.5 | A |
| | T _A =70°C, V _{GS} =4.5V(N-CH), V _{GS} =-4.5V(P-CH) | I _D | 1.6 | -1.2 | A |
| Pulsed Drain Current (Note 2) | | I _{DM} | 8 | -6 | A |
| Power Dissipation for Single Operation (Note 1) | | P _d | 0.96 | | W |
| Operating Junction and Storage Temperature | | T _j , T _{stg} | -55~+150 | | °C |
| Thermal Resistance, Junction-to-Ambient (Note 1) | | R _{th,ja} | 130 | | °C/W |
| Thermal Resistance, Junction-to-Case | | R _{th,jc} | 60 | | °C/W |

Note : 1.Surface mounted on a 0.125 in² copper pad of FR-4 board, t≤5 sec; 180°C/W when mounted on minimum copper pad.
 2.Pulse width limited by maximum junction temperature.

N-Channel Electrical Characteristics (Tj=25°C, unless otherwise specified)

| Symbol | Min. | Typ. | Max. | Unit | Test Conditions |
|---------------------------|------|------|------|------|---|
| Static | | | | | |
| BV _{DSS} | 20 | - | - | V | V _{GS} =0V, I _D =250μA |
| V _{GS(th)} | 0.3 | - | 1.0 | | V _{DS} =V _{GS} , I _D =250μA |
| I _{GSS} | - | - | ±10 | μA | V _{GS} =±8V, V _{DS} =0V |
| I _{DSS} | - | - | 1 | | V _{DS} =20V, V _{GS} =0 |
| I _{DSS} | - | - | 25 | | V _{DS} =16V, V _{GS} =0, T _j =70°C |
| *R _{DSON} | - | 73 | 95 | mΩ | V _{GS} =4.5V, I _D =1A |
| | - | 92 | 130 | | V _{GS} =2.5V, I _D =1A |
| | - | 147 | 300 | | V _{GS} =1.8V, I _D =1A |
| *G _{FS} | - | 2.5 | - | S | V _{DS} =5V, I _D =1A |
| Dynamic | | | | | |
| C _{iss} | - | 160 | - | pF | V _{DS} =10V, V _{GS} =0, f=1MHz |
| C _{oss} | - | 27 | - | | |
| C _{rss} | - | 29 | - | | |
| *t _{d(ON)} | - | 3.6 | - | ns | V _{DS} =10V, I _D =1A, V _{GS} =4.5V, R _G =6Ω |
| *t _r | - | 16.6 | - | | |
| *t _{d(OFF)} | - | 14.4 | - | | |
| *t _f | - | 5.4 | - | | |
| *Q _g | - | 2.6 | - | nC | V _{DS} =10V, I _D =1A, V _{GS} =4.5V |
| *Q _{gs} | - | 0.36 | - | | |
| *Q _{gd} | - | 0.72 | - | | |
| Source-Drain Diode | | | | | |
| *I _S | - | - | 2 | A | |
| *I _{SM} | - | - | 8 | | |
| *V _{SD} | - | 0.90 | 1.2 | V | V _{GS} =0V, I _S =2A |

*Pulse Test : Pulse Width ≤300μs, Duty Cycle ≤2%



P-Channel Electrical Characteristics (Tj=25°C, unless otherwise specified)

| Symbol | Min. | Typ. | Max. | Unit | Test Conditions |
|---------------------------|------|-------|------|------|--|
| Static | | | | | |
| BV _{DSS} | -20 | - | - | V | V _{GS} =0V, I _D =-250μA |
| V _{GS(th)} | -0.3 | - | -1.0 | | V _{DS} =V _{GS} , I _D =-250μA |
| I _{GSS} | - | - | ±10 | μA | V _{GS} =±8V, V _{DS} =0V |
| I _{DSS} | - | - | -1 | | V _{DS} =-20V, V _{GS} =0V |
| I _{DSS} | - | - | -10 | | V _{DS} =-16V, V _{GS} =0, Tj=70°C |
| *R _{DS(ON)} | - | 170 | 270 | mΩ | V _{GS} =-4.5V, I _D =-1A |
| | - | 224 | 350 | | V _{GS} =-2.5V, I _D =-1A |
| | - | 340 | 550 | | V _{GS} =-1.8V, I _D =-1A |
| *G _{FS} | - | 2.8 | - | S | V _{DS} =-5V, I _D =-1A |
| Dynamic | | | | | |
| C _{iss} | - | 204 | - | pF | V _{DS} =-10V, V _{GS} =0, f=1MHz |
| C _{oss} | - | 30 | - | | |
| C _{rss} | - | 28 | - | | |
| *t _{d(ON)} | - | 5.6 | - | ns | V _{DD} =-10V, I _D =-1A, V _{GS} =-4.5V, R _G =6Ω |
| *t _r | - | 17.8 | - | | |
| *t _{d(OFF)} | - | 16 | - | | |
| *t _f | - | 6.4 | - | | |
| *Q _g | - | 2.55 | - | nC | V _{DS} =-10V, I _D =-1A, V _{GS} =-4.5V |
| *Q _{gs} | - | 0.43 | - | | |
| *Q _{gd} | - | 0.61 | - | | |
| Source-Drain Diode | | | | | |
| *I _S | - | - | -1.5 | A | |
| *I _{SM} | - | - | -6 | | |
| *V _{SD} | - | -0.89 | -1.2 | V | V _{GS} =0V, I _S =-1A |

*Pulse Test : Pulse Width ≤300μs, Duty Cycle ≤2%

Typical Characteristics, Q1(N-Channel)

Typical Output Characteristics

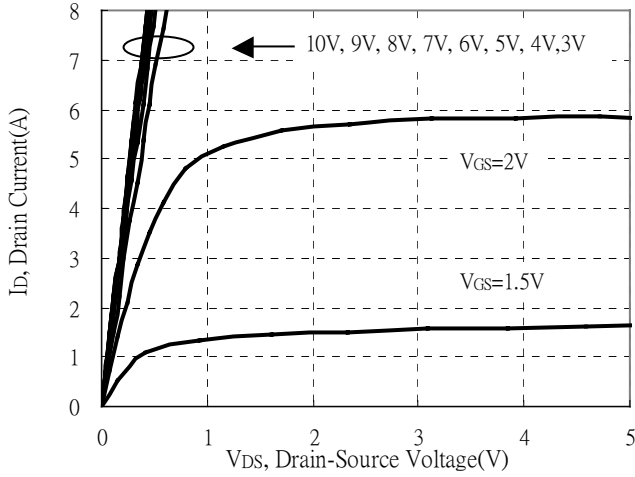

Brekdown Voltage vs Ambient Temperature

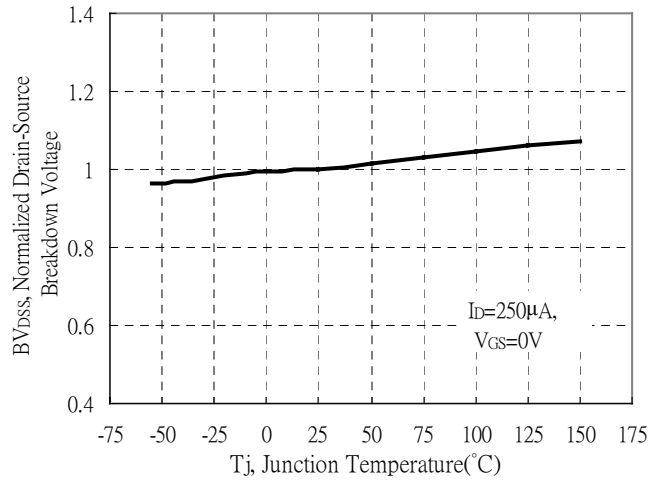

Static Drain-Source On-State resistance vs Drain Current

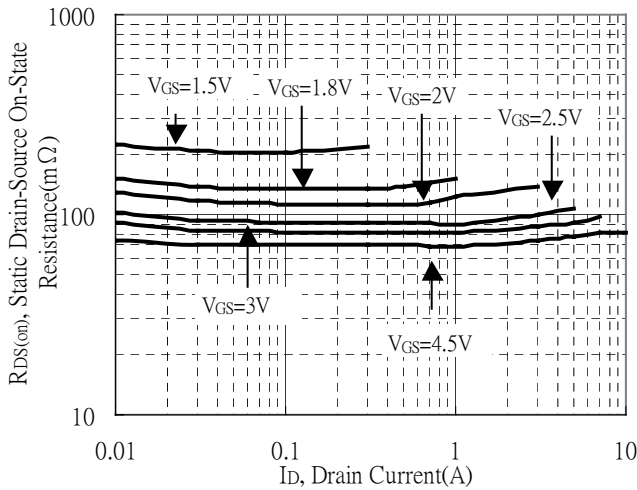

Reverse Drain Current vs Source-Drain Voltage

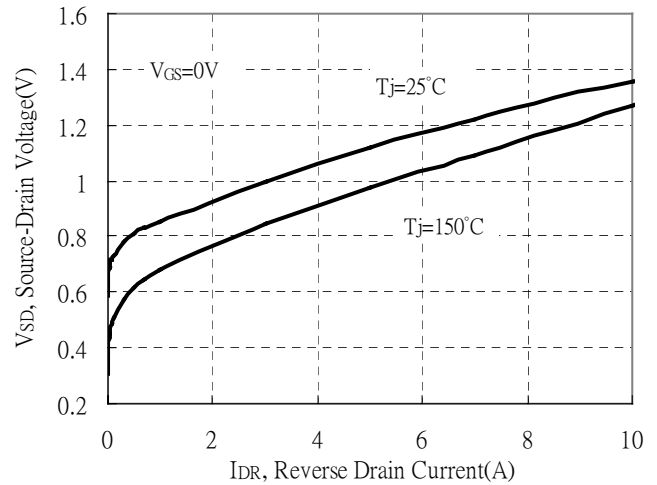

Static Drain-Source On-State Resistance vs Gate-Source Voltage

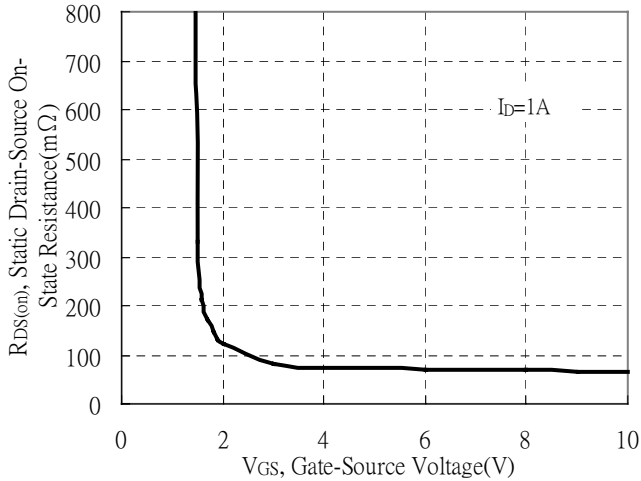

Drain-Source On-State Resistance vs Junction Temperature

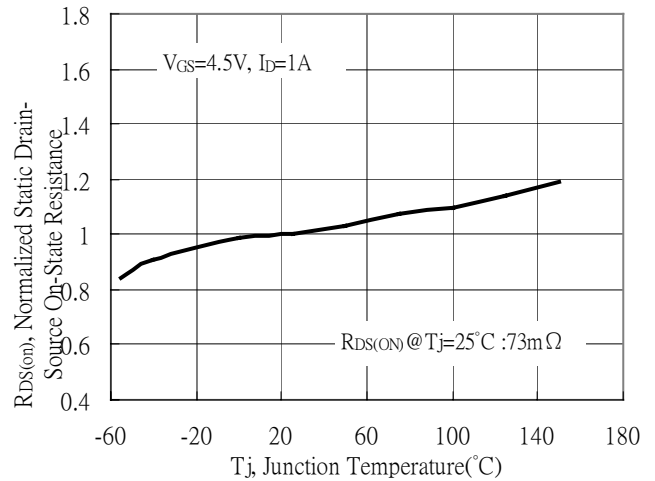

Typical Characteristics(Cont.), Q1(N-Channel)

Capacitance vs Drain-to-Source Voltage

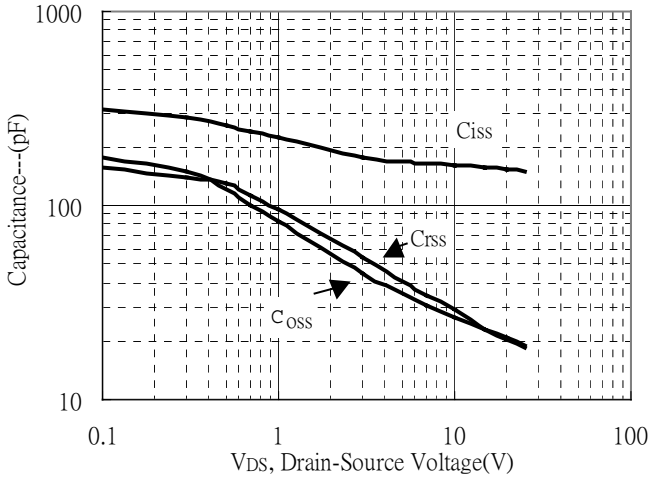

Threshold Voltage vs Junction Temperature

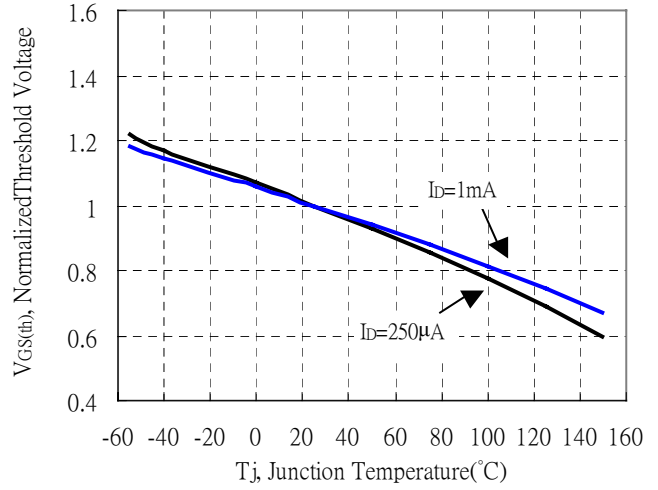

Single Pulse Power Rating, Junction to Ambient

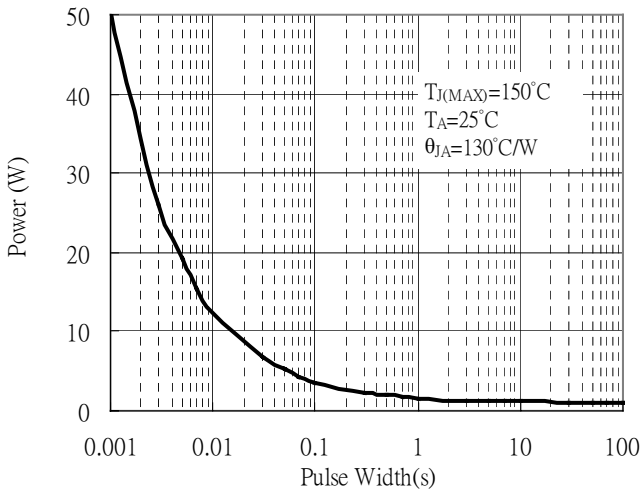

Gate Charge Characteristics

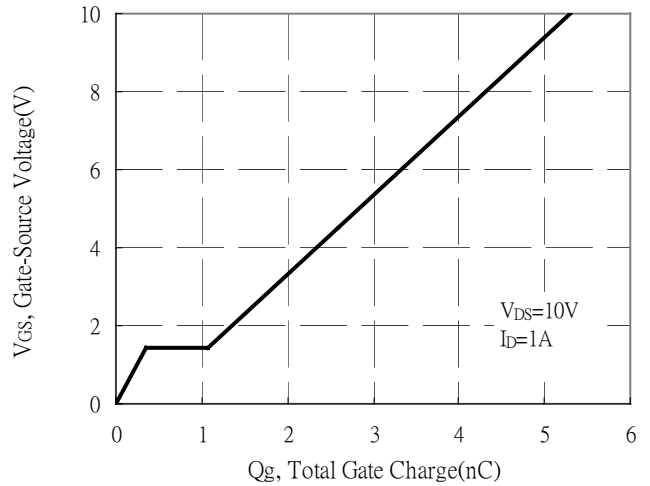

Maximum Safe Operating Area

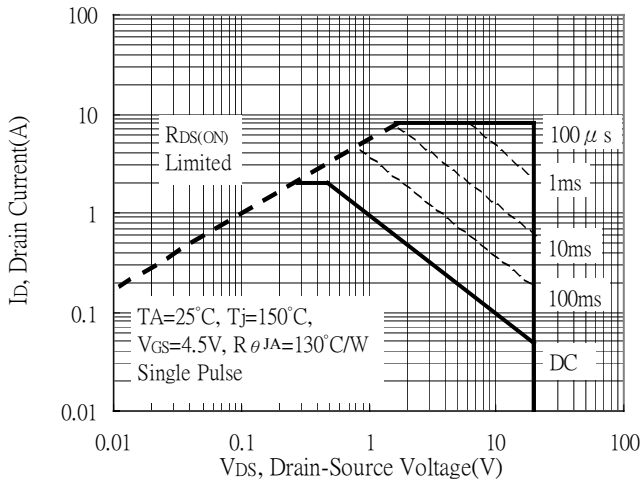

Maximum Drain Current vs Junction Temperature

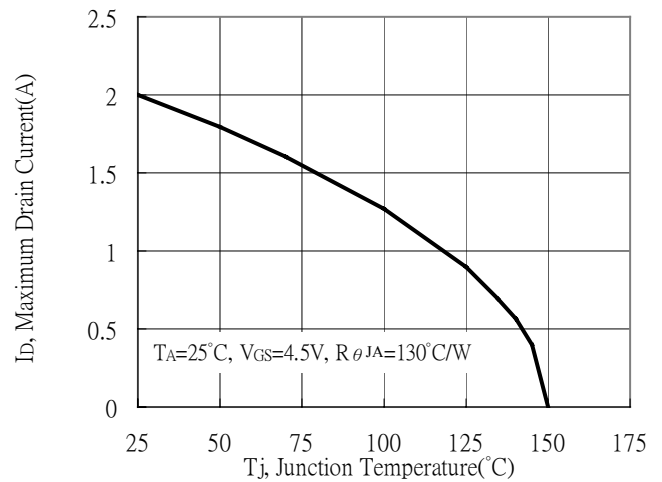

Typical Characteristics(Cont.), Q1(N-Channel)

Typical Transfer Characteristics

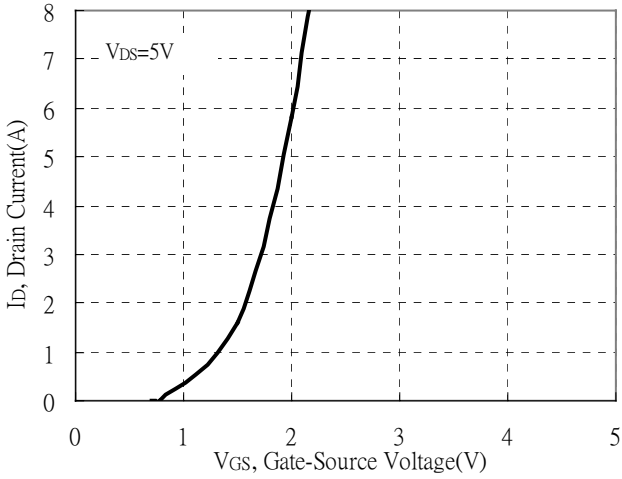

Forward Transfer Admittance vs Drain Current

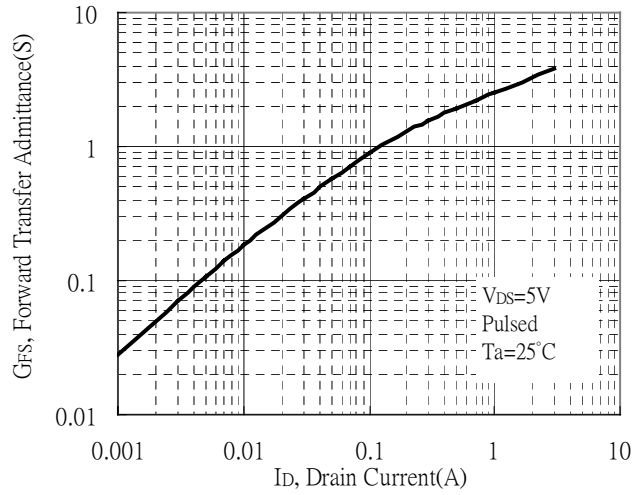

Transient Thermal Response Curves

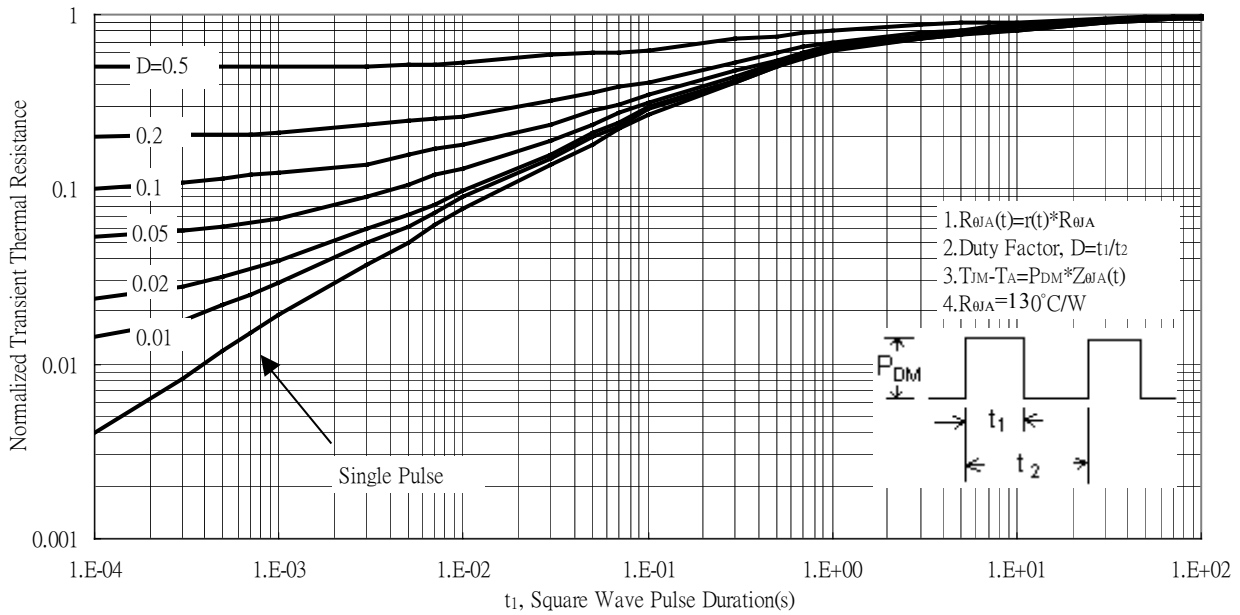

Typical Characteristics, Q2(P-Channel)

Typical Output Characteristics

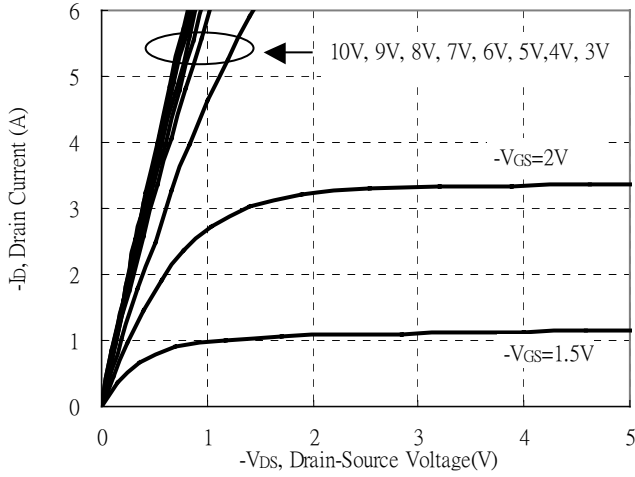

Breakdown Voltage vs Ambient Temperature

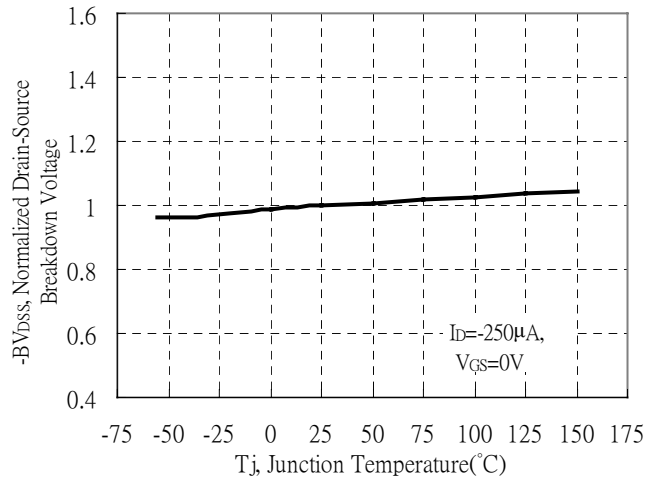

Static Drain-Source On-State resistance vs Drain Current

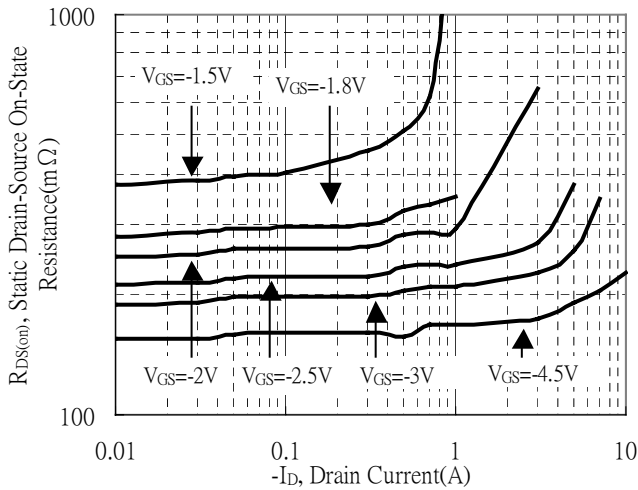

Reverse Drain Current vs Source-Drain Voltage

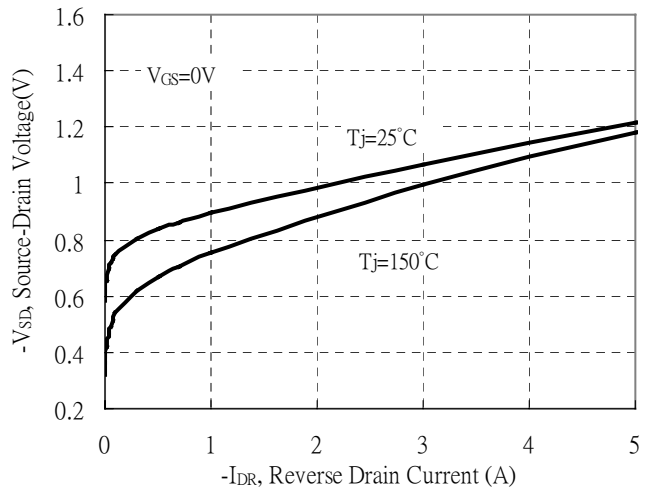

Static Drain-Source On-State Resistance vs Gate-Source Voltage

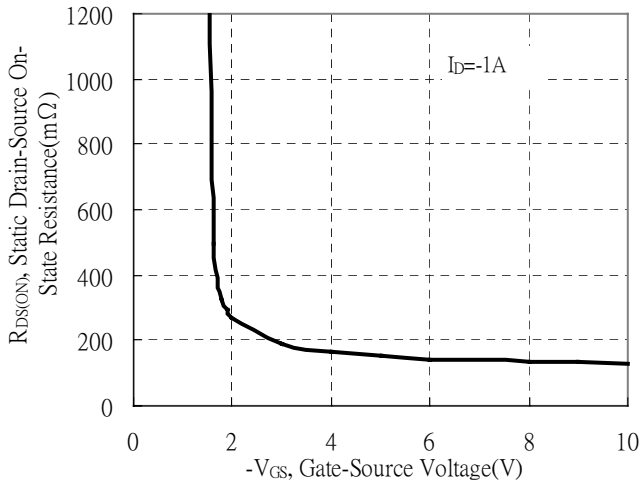

Drain-Source On-State Resistance vs Junction Temperature

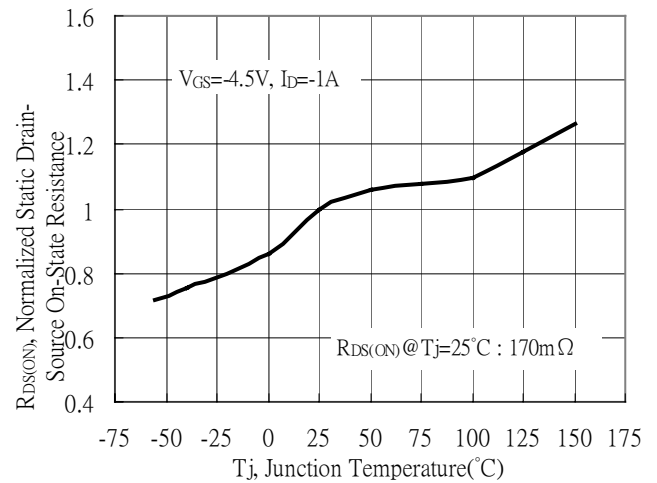

Typical Characteristics(Cont.), Q1(N-Channel)

Capacitance vs Drain-to-Source Voltage

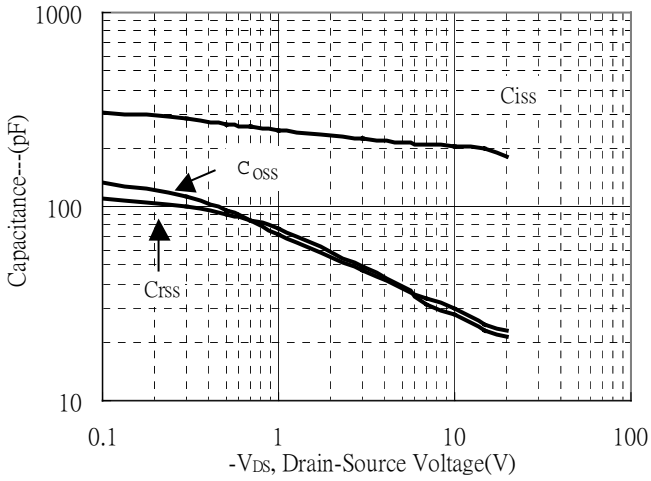

Threshold Voltage vs Junction Temperature

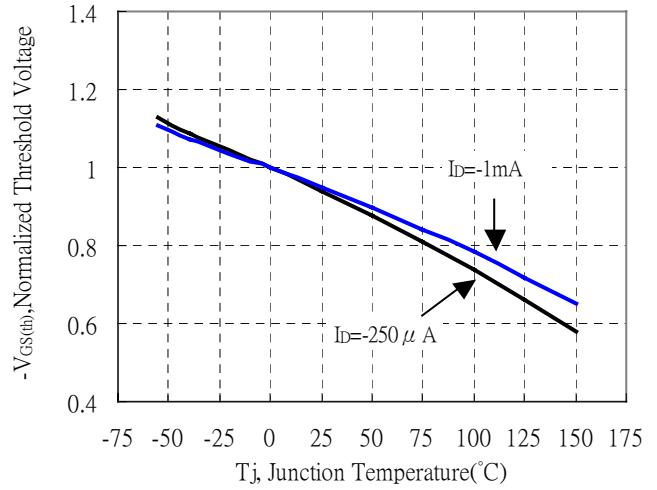

Single Pulse Power Rating, Junction to Ambient

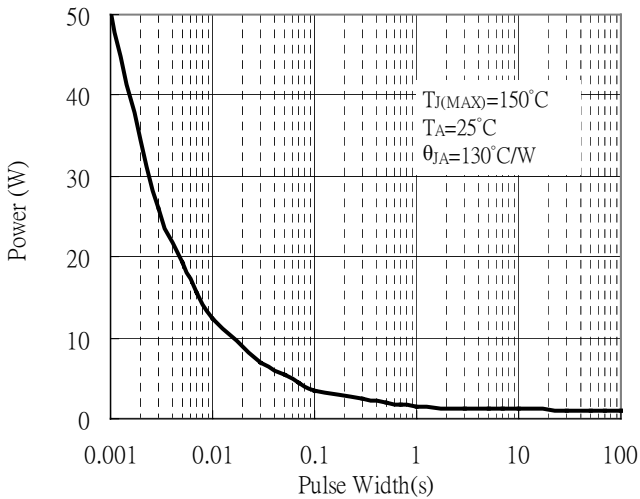

Gate Charge Characteristics

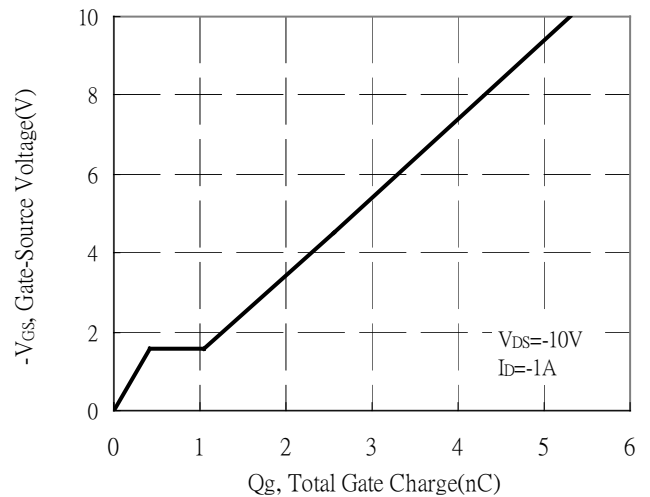

Maximum Safe Operating Area

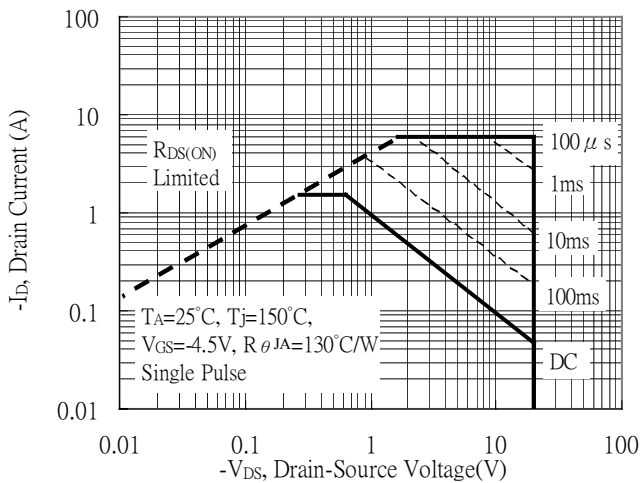

Maximum Drain Current vs Junction Temperature

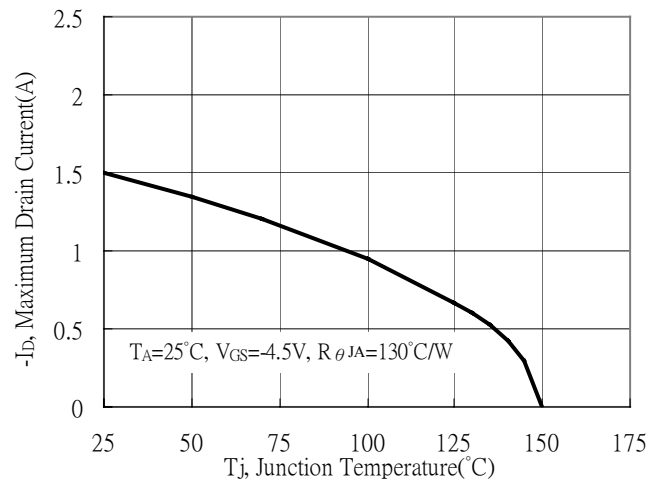

Typical Characteristics(Cont.), Q1(N-Channel)

Typical Transfer Characteristics

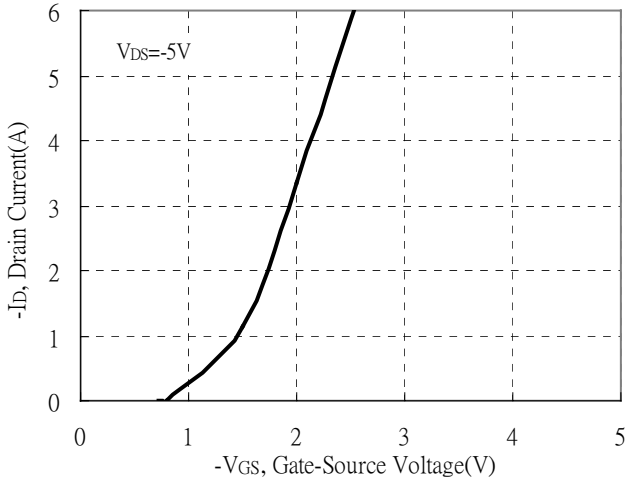

Forward Transfer Admittance vs Drain Current

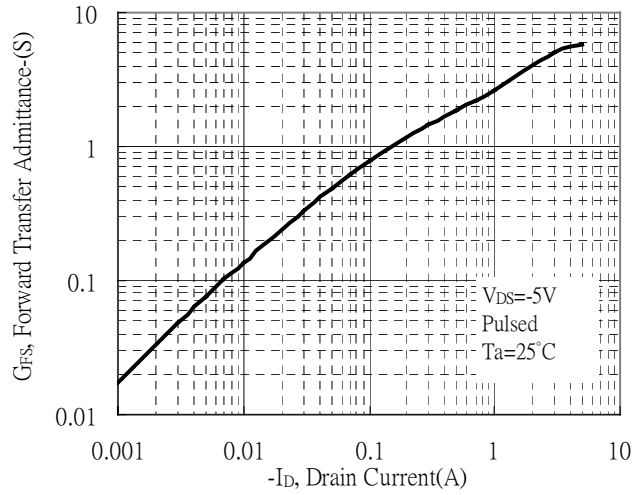

Transient Thermal Response Curves

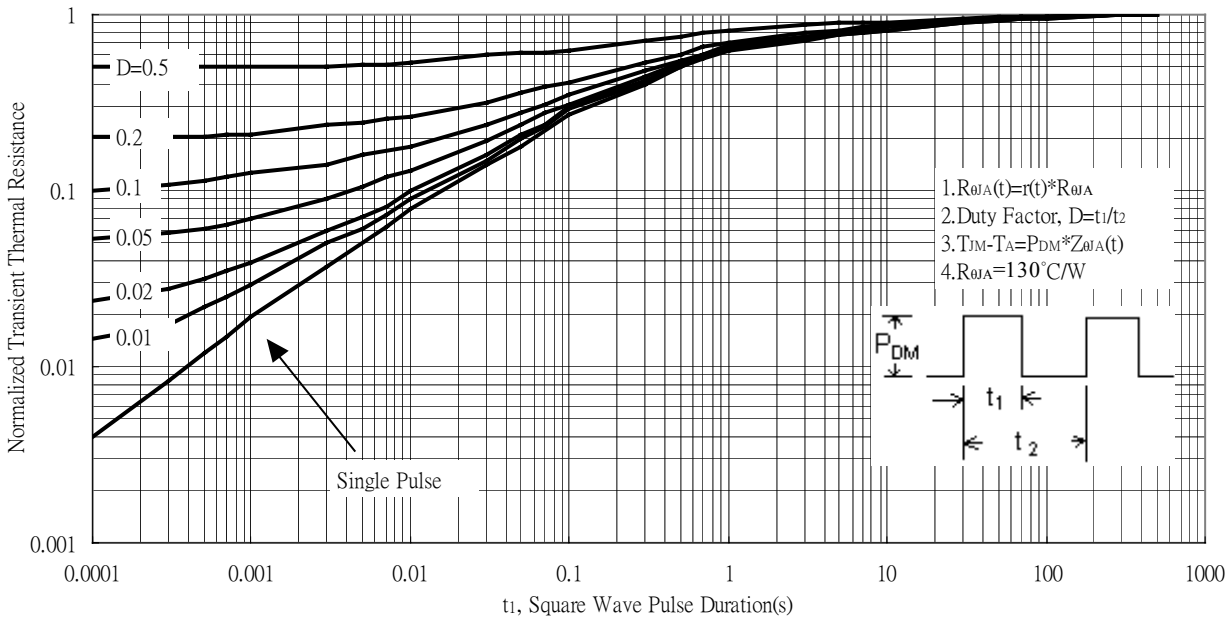

Reel Dimension

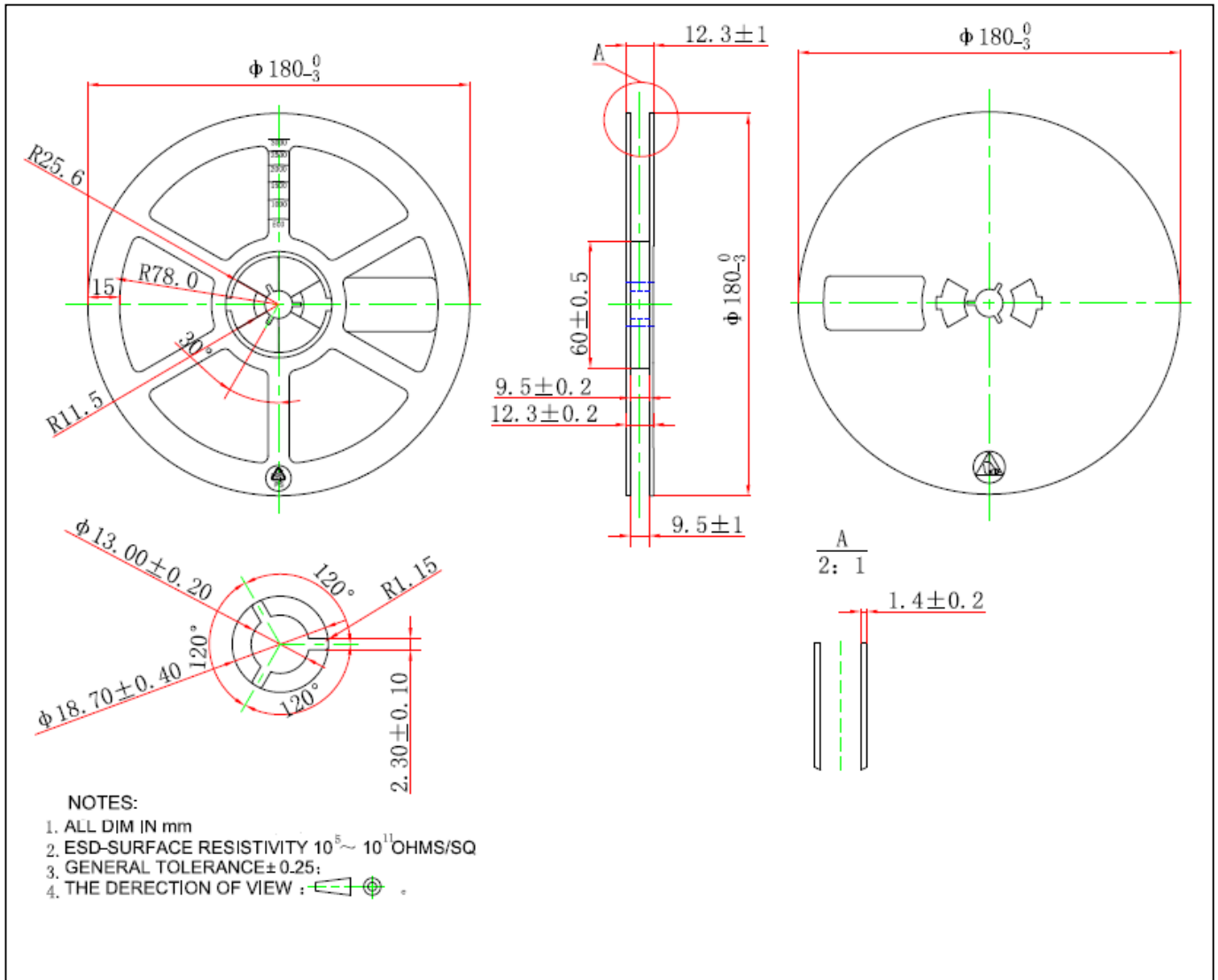

Carrier Tape Dimension

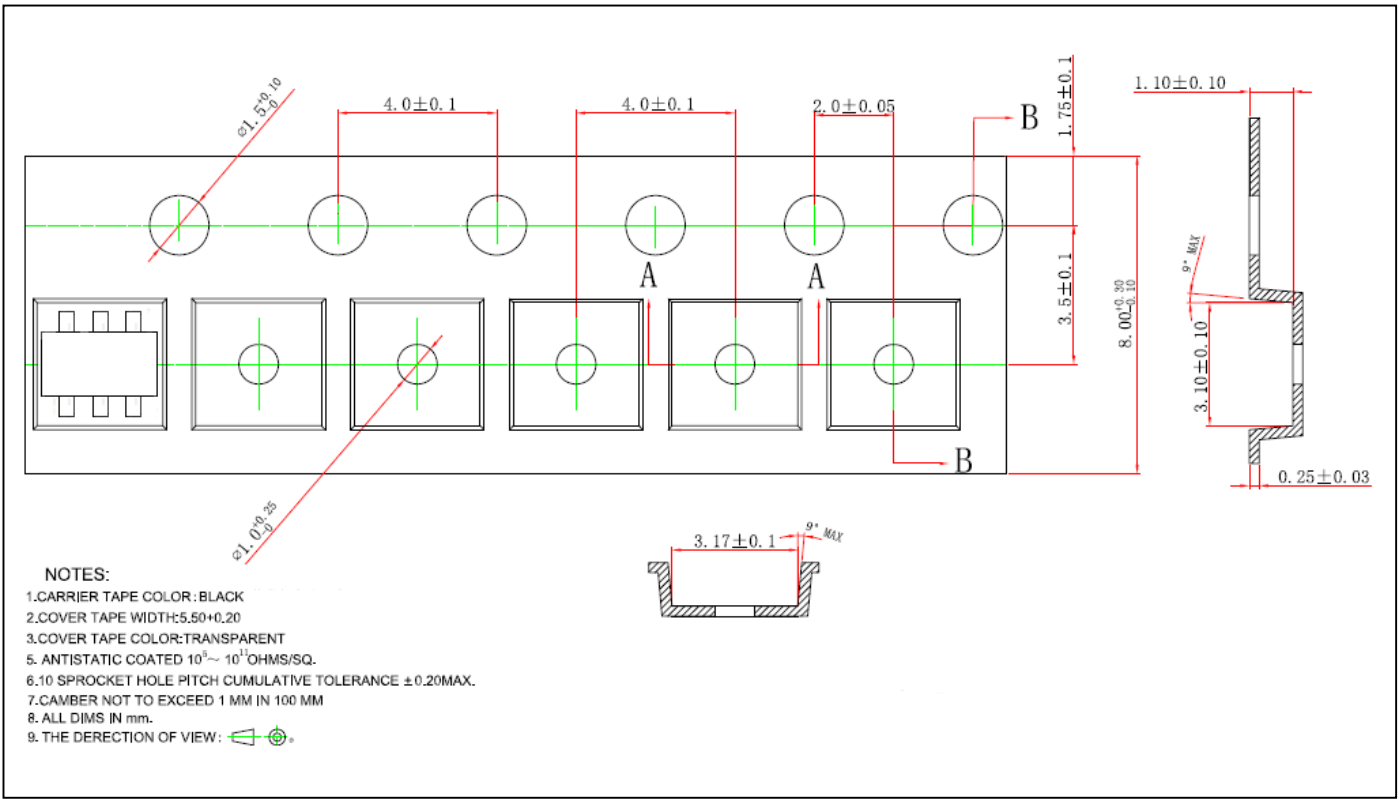

Recommended wave soldering condition

| | | |
|-----------------|------------------|-----------------|
| Product | Peak Temperature | Soldering Time |
| Pb-free devices | 260 +0/-5 °C | 5 +1/-1 seconds |

Recommended temperature profile for IR reflow

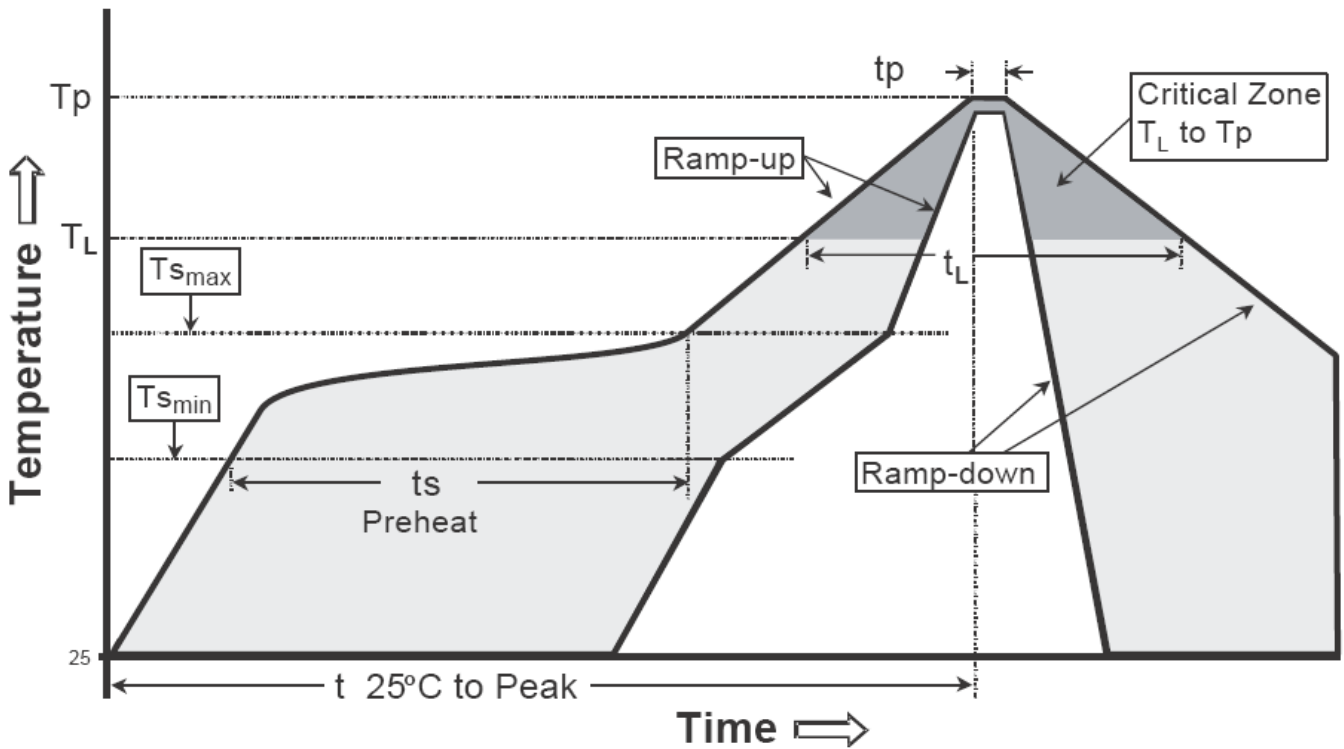

| Profile feature | Sn-Pb eutectic Assembly | Pb-free Assembly |
|---|-------------------------|------------------|
| Average ramp-up rate (T _{smax} to T _p) | 3°C/second max. | 3°C/second max. |
| Preheat | | |
| -Temperature Min(T _{s min}) | 100°C | 150°C |
| -Temperature Max(T _{s max}) | 150°C | 200°C |
| -Time(t _{s min} to t _{s max}) | 60-120 seconds | 60-180 seconds |
| Time maintained above: | | |
| -Temperature (T _L) | 183°C | 217°C |
| - Time (t _L) | 60-150 seconds | 60-150 seconds |
| Peak Temperature(T _P) | 240 +0/-5 °C | 260 +0/-5 °C |
| Time within 5°C of actual peak temperature(tp) | 10-30 seconds | 20-40 seconds |
| Ramp down rate | 6°C/second max. | 6°C/second max. |
| Time 25 °C to peak temperature | 6 minutes max. | 8 minutes max. |

Note : All temperatures refer to topside of the package, measured on the package body surface.

TSOP-6 Dimension

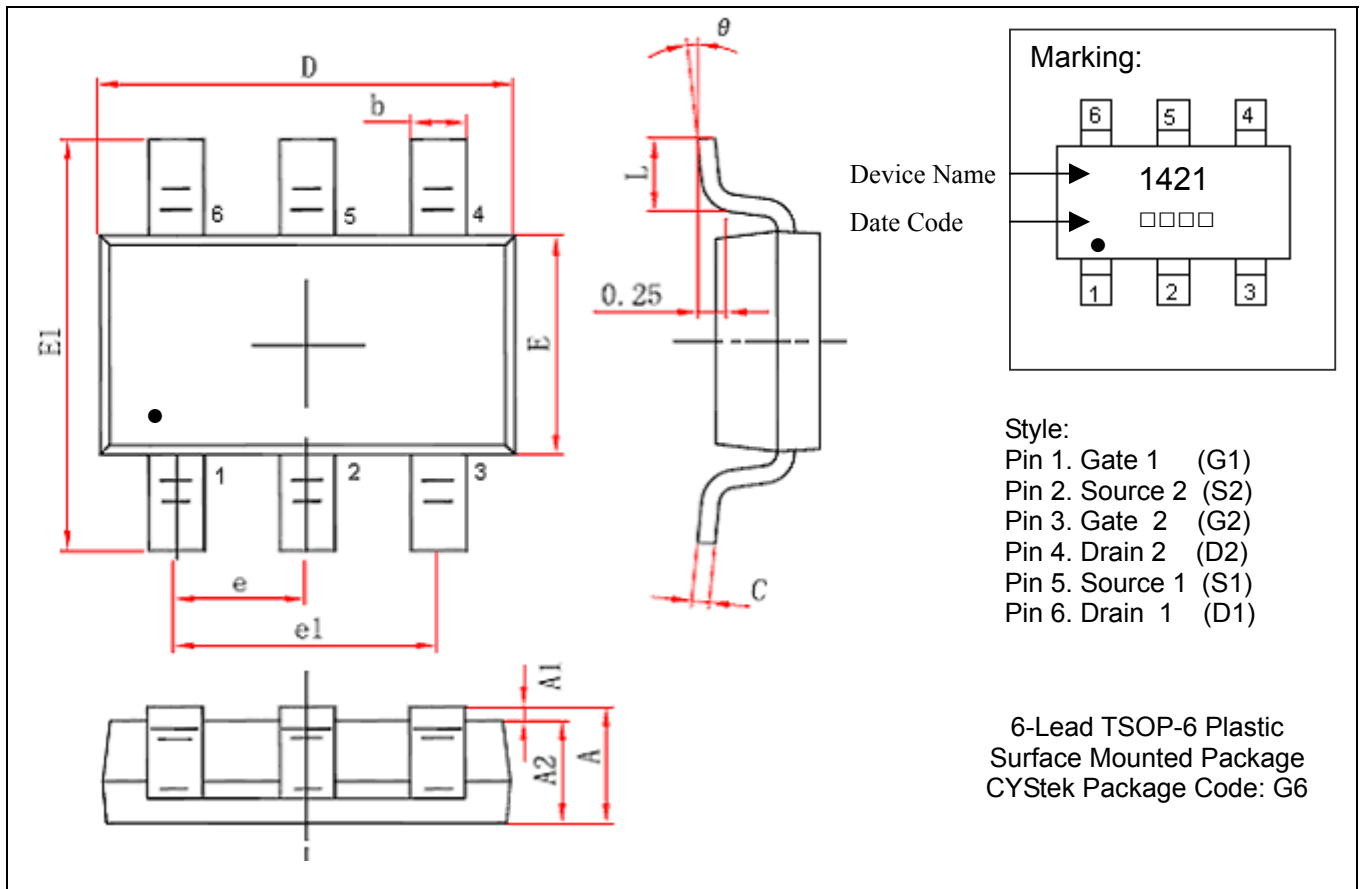

| DIM | Millimeters | | Inches | | DIM | Millimeters | | Inches | |
|-----|-------------|-------|--------|-------|----------|-------------|-------|-------------|-------|
| | Min. | Max. | Min. | Max. | | Min. | Max. | Min. | Max. |
| A | 0.700 | 0.900 | 0.028 | 0.035 | E | 1.600 | 1.700 | 0.063 | 0.067 |
| A1 | 0.000 | 0.100 | 0.000 | 0.004 | E1 | 2.650 | 2.950 | 0.104 | 0.116 |
| A2 | 0.700 | 0.800 | 0.028 | 0.031 | e | 0.95 (BSC) | | 0.037 (BSC) | |
| b | 0.350 | 0.500 | 0.014 | 0.020 | e1 | 1.90 (BSC) | | 0.075 (BSC) | |
| c | 0.080 | 0.200 | 0.003 | 0.008 | L | 0.300 | 0.600 | 0.012 | 0.024 |
| D | 2.820 | 3.020 | 0.111 | 0.119 | θ | 0° | 8° | 0° | 8° |

Notes : 1.Controlling dimension : millimeters.
 2.Maximum lead thickness includes lead finish thickness, and minimum lead thickness is the minimum thickness of base material.
 3.If there is any question with packing specification or packing method, please contact your local CYStek sales office.

Material :

- Lead : Pure tin plated.
- Mold Compound : Epoxy resin family, flammability solid burning class:UL94V-0.

Important Notice:

- All rights are reserved. Reproduction in whole or in part is prohibited without the prior written approval of CYStek.
- CYStek reserves the right to make changes to its products without notice.
- CYStek **semiconductor products are not warranted to be suitable for use in Life-Support Applications, or systems.**
- CYStek assumes no liability for any consequence of customer product design, infringement of patents, or application assistance.