

N- AND P-CHANNEL ENHANCEMENT MODE POWER MOSFET

MTC4503LQ8

Description

The MTC4503LQ8 consists of a N-channel and a P-channel enhancement-mode MOSFET in a single SOP-8 package, providing the designer with the best combination of fast switching, ruggedized device design, low on-resistance and cost-effectiveness.

The SOP-8 package is universally preferred for all commercial-industrial surface mount applications and suited for low voltage applications such as DC/DC converters.

Features

- Simple drive requirement
- Low on-resistance
- Fast switching speed
- Pb-free lead plating and halogen-free package

Applications

- Power management in notebook computer, portable equipment and battery powered systems.

Equivalent Circuit

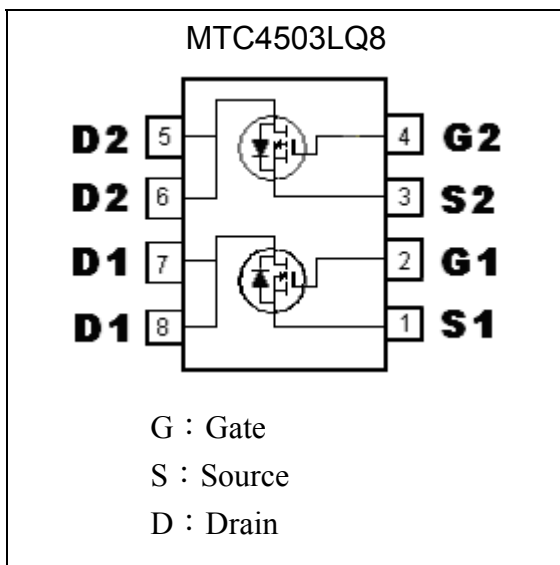

Outline

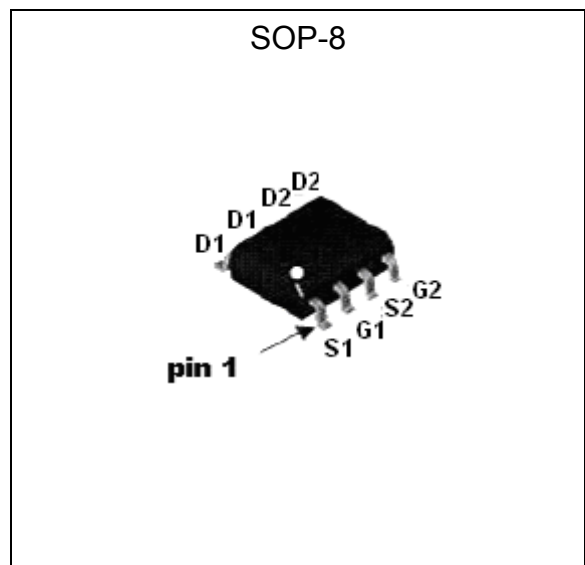



Absolute Maximum Ratings (Ta=25°C)

Parameter	Symbol	Limits		Unit
		N-channel	P-channel	
Drain-Source Breakdown Voltage	BVDSS	30	-30	V
Gate-Source Voltage	VGS	±20	±20	V
Continuous Drain Current @TA=25 °C (Note 1)	ID	6.9	-6.3	A
Continuous Drain Current @TA=70 °C (Note 1)	ID	5.5	-5.0	A
Pulsed Drain Current (Note 2)	IDM	30	-30	A
Single Avalanche Current	IAS	6.9	-6.3	A
Total Power Dissipation @TA=25°C (Note 1)	Pd	2		W
Linear Derating Factor		0.016		W / °C
Operating Junction and Storage Temperature Range	Tj; Tstg	-55~+150		°C
Thermal Resistance, Junction-to-Case	RθJC	25		°C/W
Thermal Resistance, Junction-to-Ambient (Note 1)	RθJA	62.5		°C/W

Note : 1.Surface mounted on 1 in² copper pad of FR-4 board, 135°C/W when mounted on minimum copper pad
 2.Pulse width limited by maximum junction temperature

N-Channel Electrical Characteristics (Tj=25°C, unless otherwise specified)

Symbol	Min.	Typ.	Max.	Unit	Test Conditions
Static					
BVDSS	30	-	-	V	VGS=0, ID=250μA
ΔBVDSS/ΔTj	-	0.005	-	V/°C	Reference to 25°C, ID=1mA
VGS(th)	1.0	-	2.5	V	VDS=VGS, ID=250μA
IGSS	-	-	±100	nA	VGS=±20V, VDS=0
IDSS	-	-	1	μA	VDS=30V, VGS=0
IDSS	-	-	25	μA	VDS=24V, VGS=0, Tj=70°C
*RDS(ON)	-	-	28	mΩ	ID=6A, VGS=10V
	-	-	42		ID=4A, VGS=4.5V
*GFS	-	5.7	-	S	VDS=10V, ID=6A
Dynamic					
Ciss	-	610	970	pF	VDS=25V, VGS=0, f=1MHz
Coss	-	160	-		
Crss	-	120	-		
*td(ON)	-	8	-	ns	VDS=15V, ID=1A, VGS=10V, RG=3.3Ω, RD=15Ω
*tr	-	7	-		
*td(OFF)	-	19	-		
*tf	-	6	-		
*Qg	-	9	15	nC	VDS=24V, ID=6A, VGS=4.5V
*Qgs	-	2	-		
*Qgd	-	6	-		
Body Diode					
*VF(S-D)	-	0.88	1.2	V	VGS=0V, IF=6.9A
*trr	-	18	-	ns	IF=6.9A, VGS=0V, dI/dt=100A/μs
*Qrr	-	11	-	nC	

*Pulse Test : Pulse Width ≤300μs, Duty Cycle ≤2%



P-Channel Electrical Characteristics (Tj=25°C, unless otherwise specified)

Symbol	Min.	Typ.	Max.	Unit	Test Conditions
Static					
BV _{DSS}	-30	-	-	V	V _{GS} =0, I _D =-250μA
ΔBV _{DSS} /ΔT _j	-	-0.004	-	V/°C	Reference to 25°C, I _D =-1mA
V _{GS(th)}	-0.8	-	-1.5	V	V _{DS} =V _{GS} , I _D =-250μA
I _{GSS}	-	-	±100	nA	V _{GS} =±20V, V _{DS} =0
I _{DSS}	-	-	-1	μA	V _{DS} =-30V, V _{GS} =0
I _{DSS}	-	-	-25	μA	V _{DS} =-24V, V _{GS} =0, T _j =70°C
*R _{DS(ON)}	-	-	36	mΩ	I _D =-6A, V _{GS} =-10V
	-	-	55		I _D =-4A, V _{GS} =-4.5V
*G _{FS}	-	5.8	-	S	V _{DS} =-10V, I _D =-6A
Dynamic					
C _{iSS}	-	960	1540	pF	V _{DS} =-25V, V _{GS} =0, f=1MHz
C _{oSS}	-	300	-		
C _{rSS}	-	220	-		
*t _{d(ON)}	-	12	-	ns	V _{DS} =-15V, I _D =-1A, V _{GS} =-10V, R _G =3.3Ω, R _D =15Ω
*t _r	-	8	-	ns	
*t _{d(OFF)}	-	42	-	ns	
*t _f	-	34	-	ns	
*Q _g	-	15	24	nC	V _{DS} =-24V, I _D =-6A, V _{GS} =-4.5V
*Q _{gs}	-	3	-	nC	
*Q _{gd}	-	9	-	nC	
Body Diode					
*V _{F(S-D)}	-	0.89	1.2	V	V _{GS} =0V, I _F =6.3A
*t _{rr}	-	24	-	ns	I _F =6.3A, V _{GS} =0V, dI/dt=100A/μs
*Q _{rr}	-	18	-	nC	

*Pulse Test : Pulse Width ≤300μs, Duty Cycle≤2%

Ordering Information

Device	Package	Shipping
MTC4503LQ8-0-T3-G	SOP-8 (Pb-free lead plating and halogen-free package)	2500 pcs / Tape & Reel

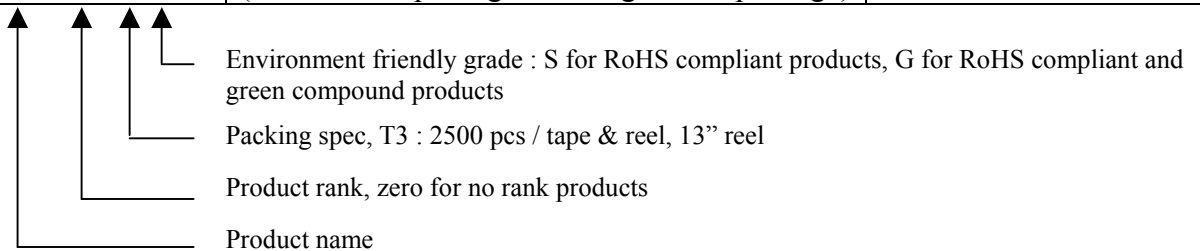

N-channel Characteristic Curves

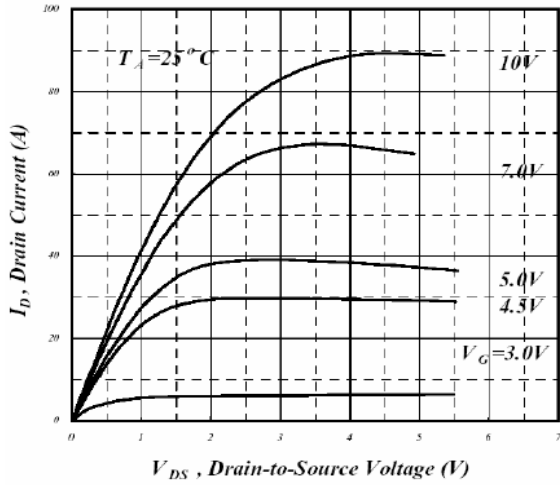

Fig 1. Typical Output Characteristics

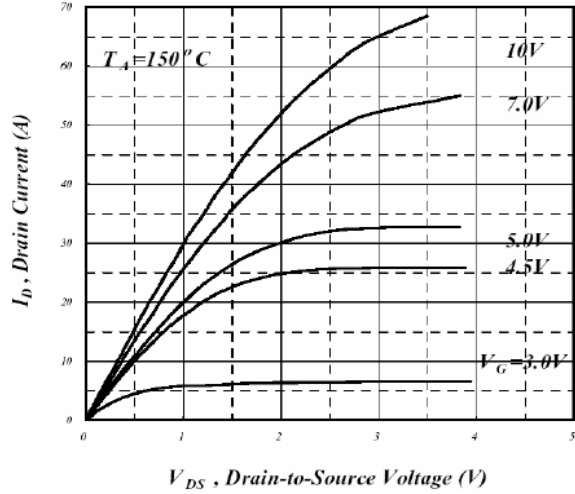

Fig 2. Typical Output Characteristics

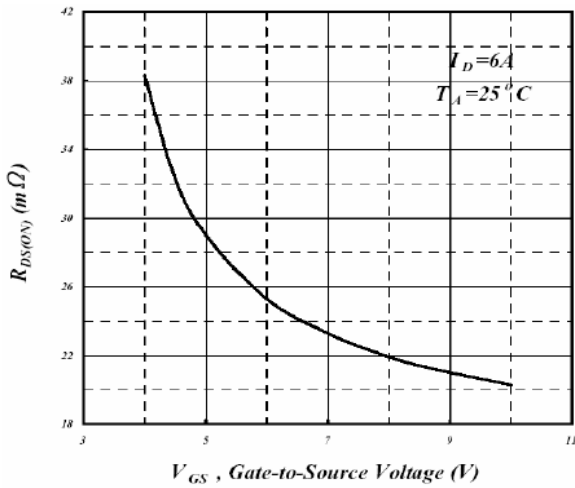

Fig 3. On-Resistance v.s. Gate Voltage

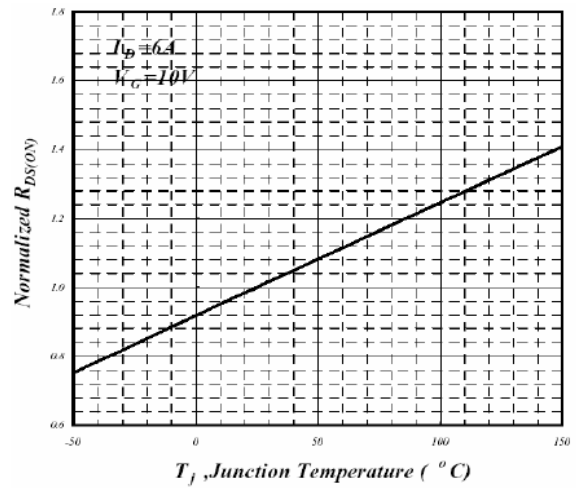

Fig 4. Normalized On-Resistance v.s. Junction Temperature

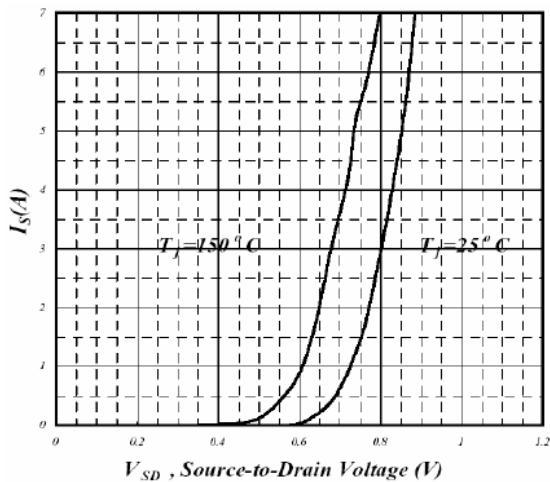

Fig 5. Forward Characteristics of Reverse Diode

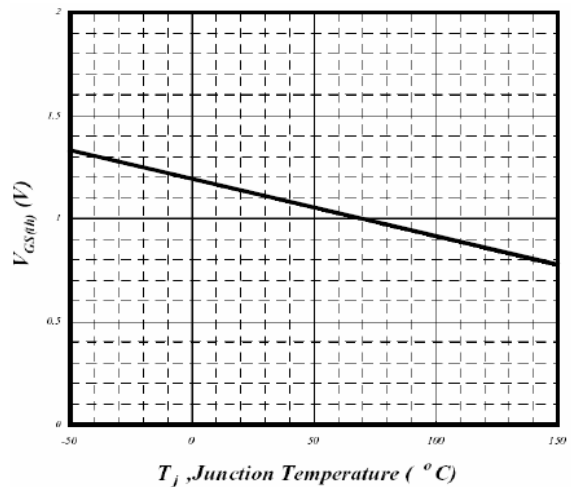

Fig 6. Gate Threshold Voltage v.s. Junction Temperature

N-channel Characteristic Curves(Cont.)

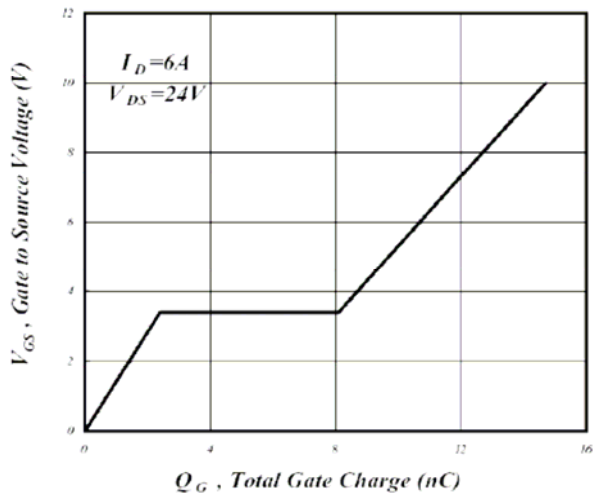

Fig 7. Gate Charge Characteristics

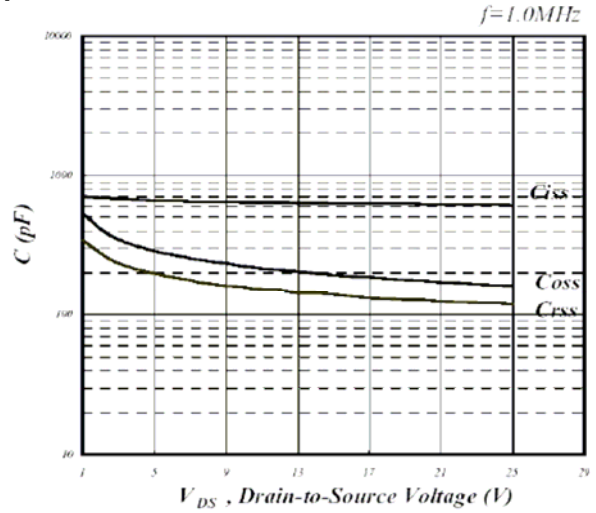

Fig 8. Typical Capacitance Characteristics

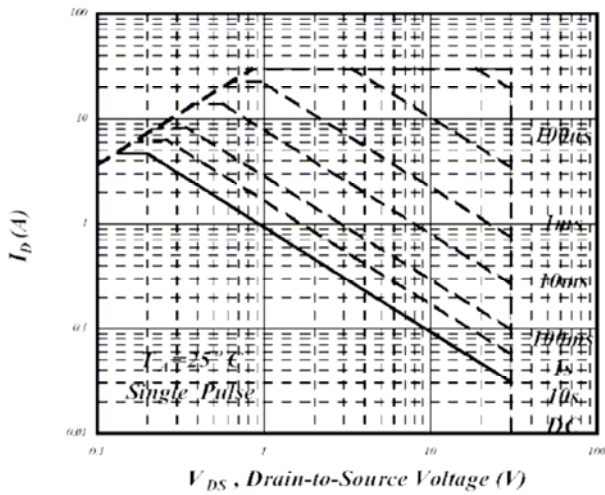

Fig 9. Maximum Safe Operating Area

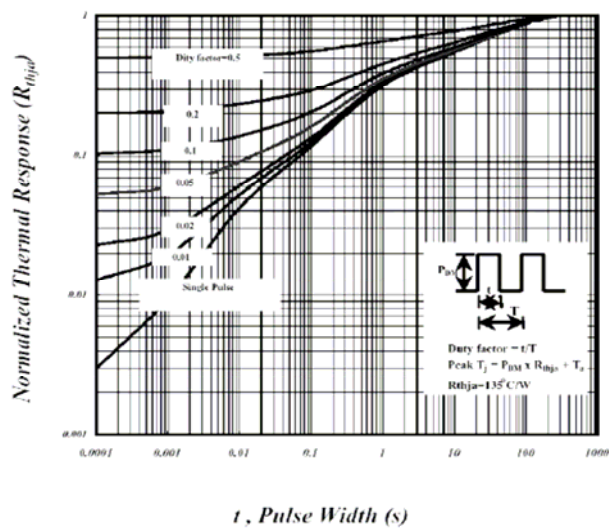

Fig 10. Effective Transient Thermal Impedance

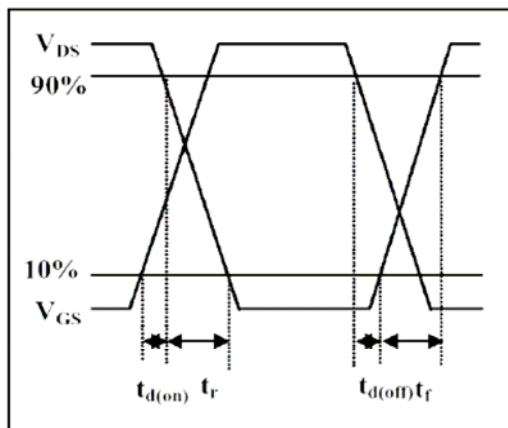

Fig 11. Switching Time Waveform

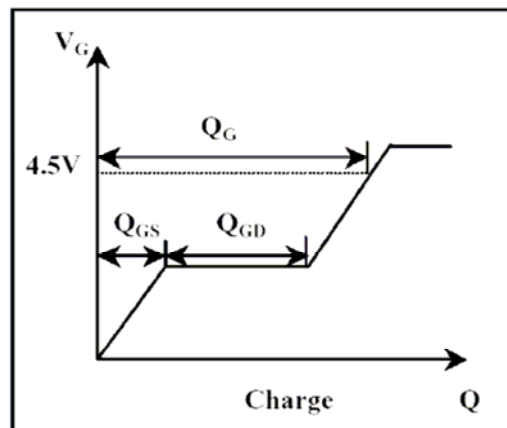

Fig 12. Gate Charge Waveform

P-channel Characteristic Curves

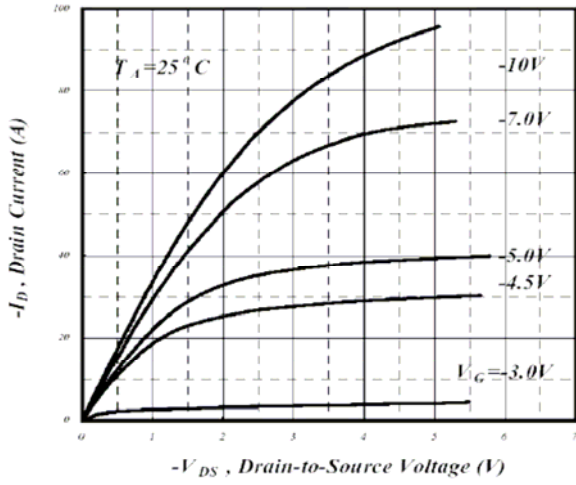

Fig 1. Typical Output Characteristics

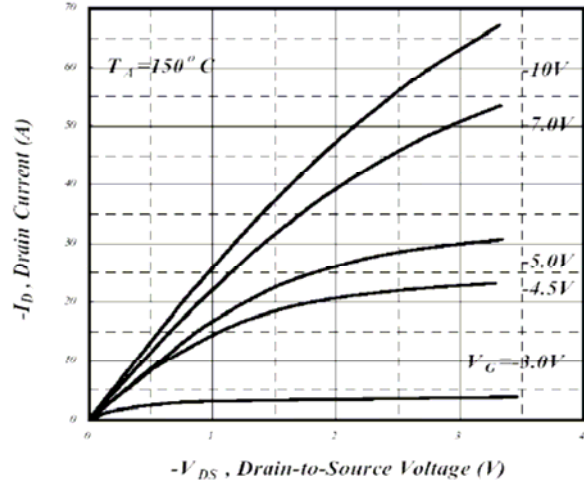

Fig 2. Typical Output Characteristics

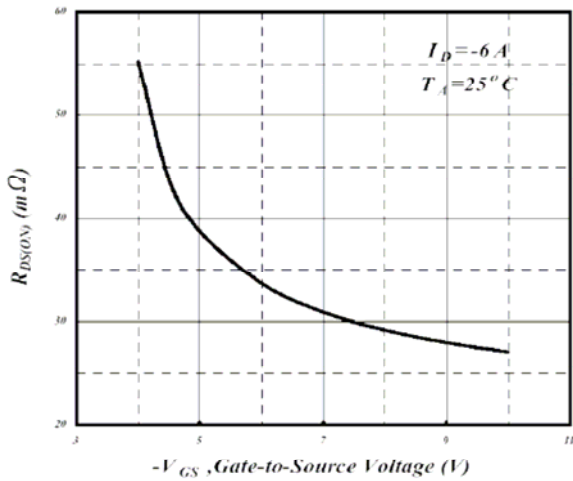

Fig 3. On-Resistance v.s. Gate Voltage

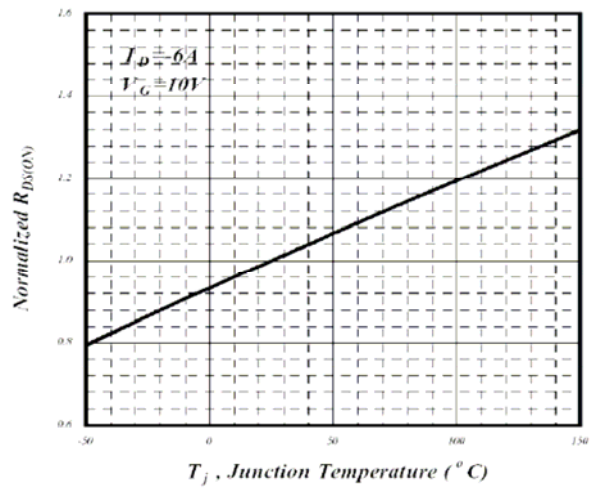

Fig 4. Normalized On-Resistance v.s. Junction Temperature

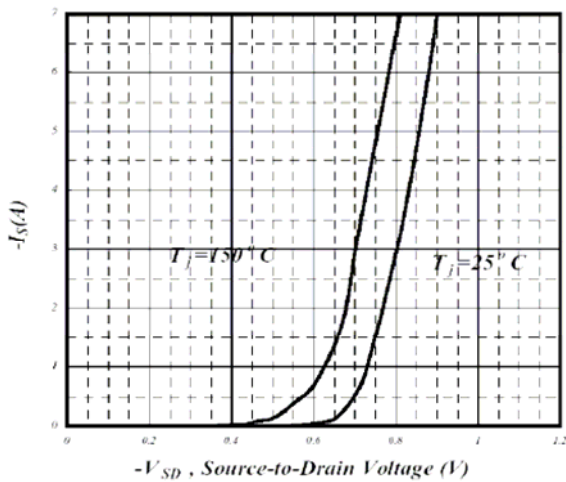

Fig 5. Forward Characteristics of Reverse Diode

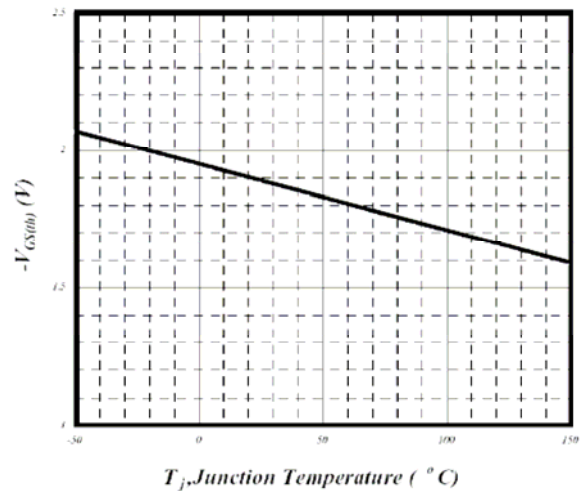

Fig 6. Gate Threshold Voltage v.s. Junction Temperature

P-channel Characteristic Curves(Cont.)

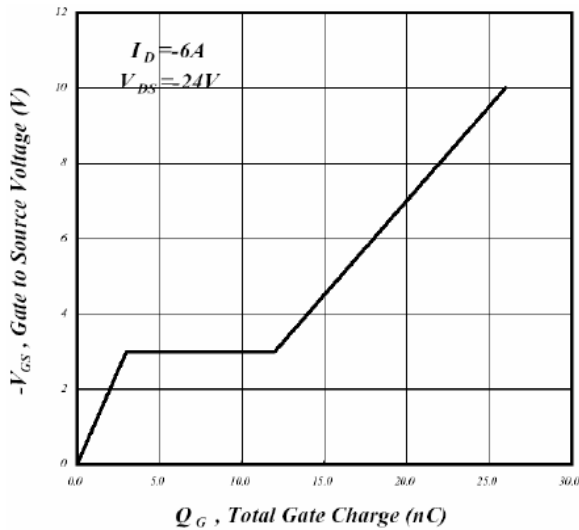

Fig 7. Gate Charge Characteristics

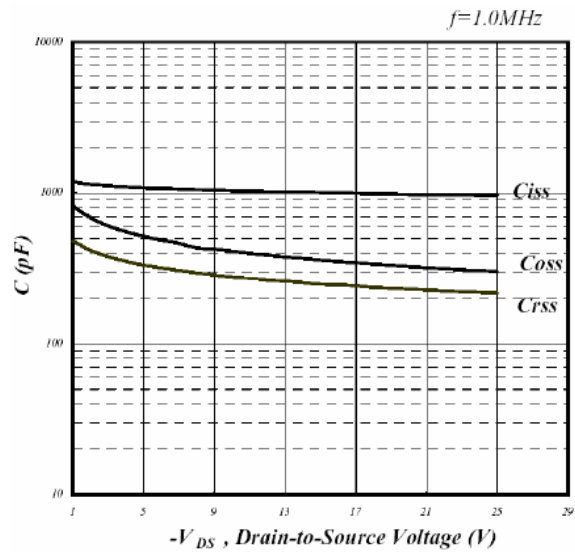

Fig 8. Typical Capacitance Characteristics

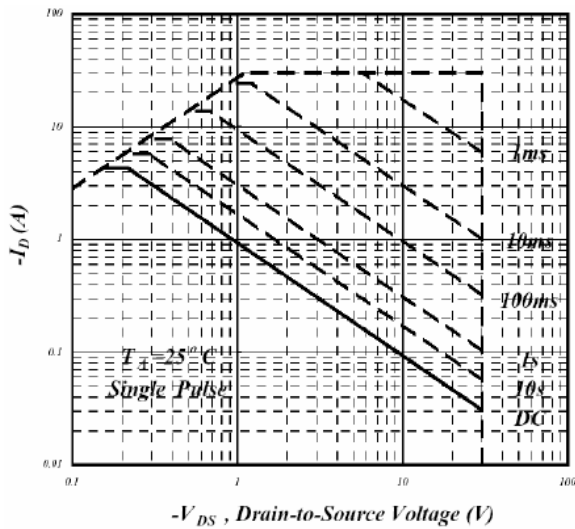

Fig 9. Maximum Safe Operating Area

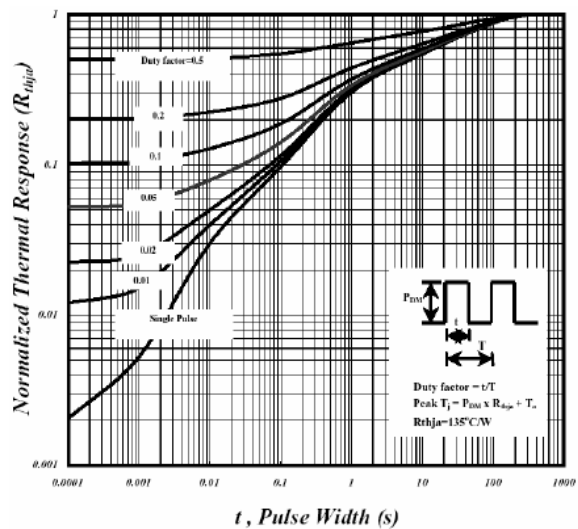

Fig 10. Effective Transient Thermal Impedance

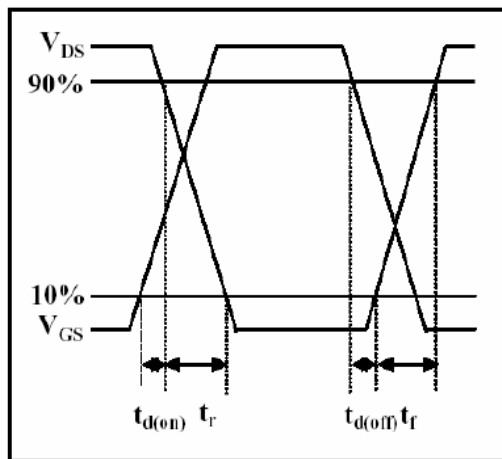

Fig 11. Switching Time Waveform

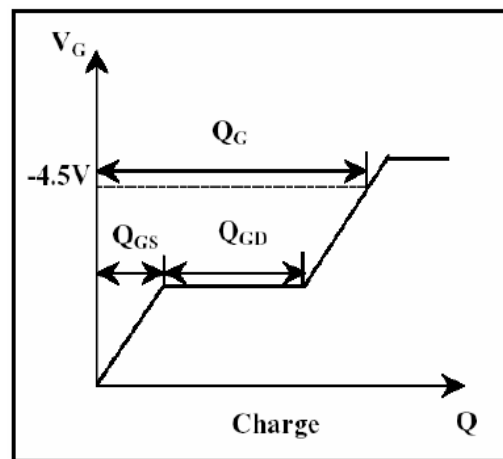
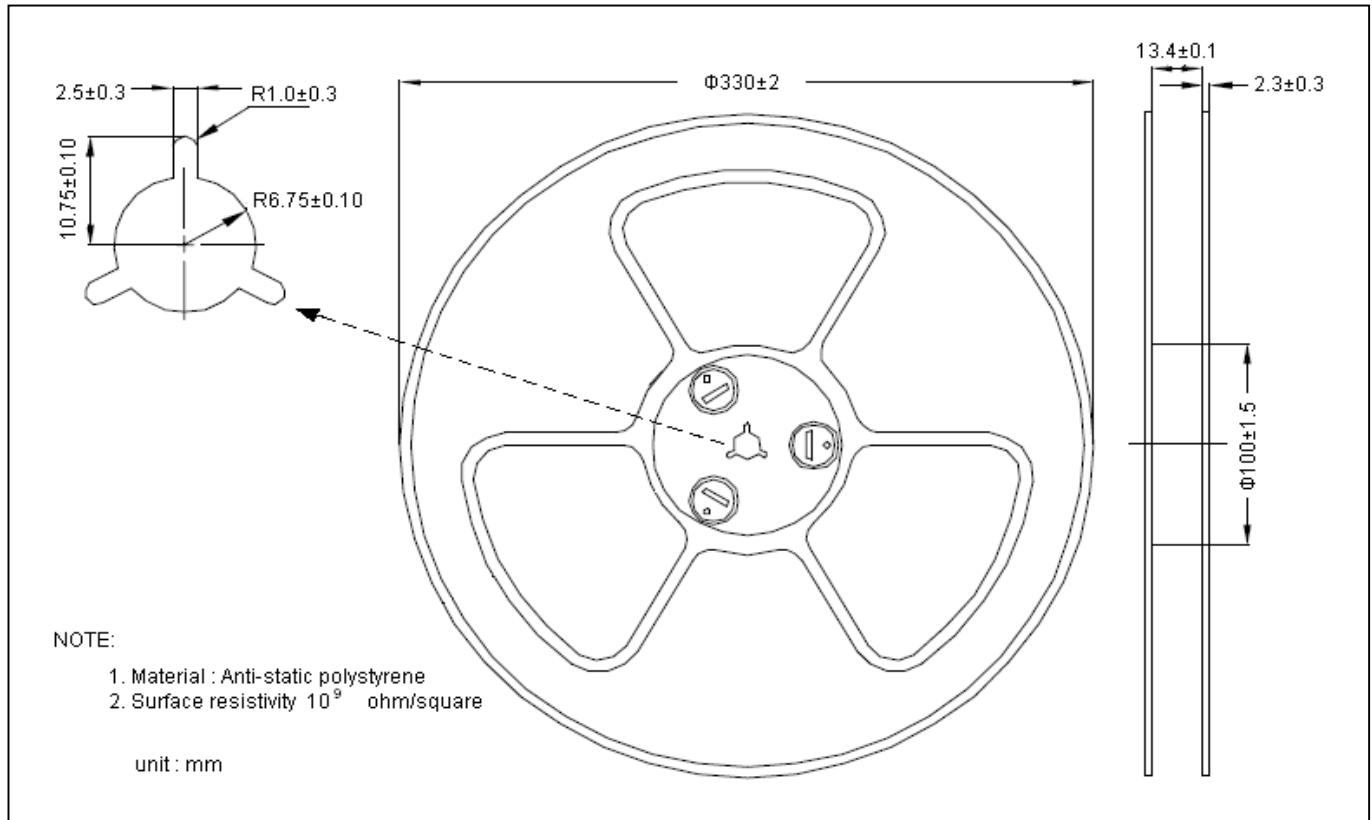
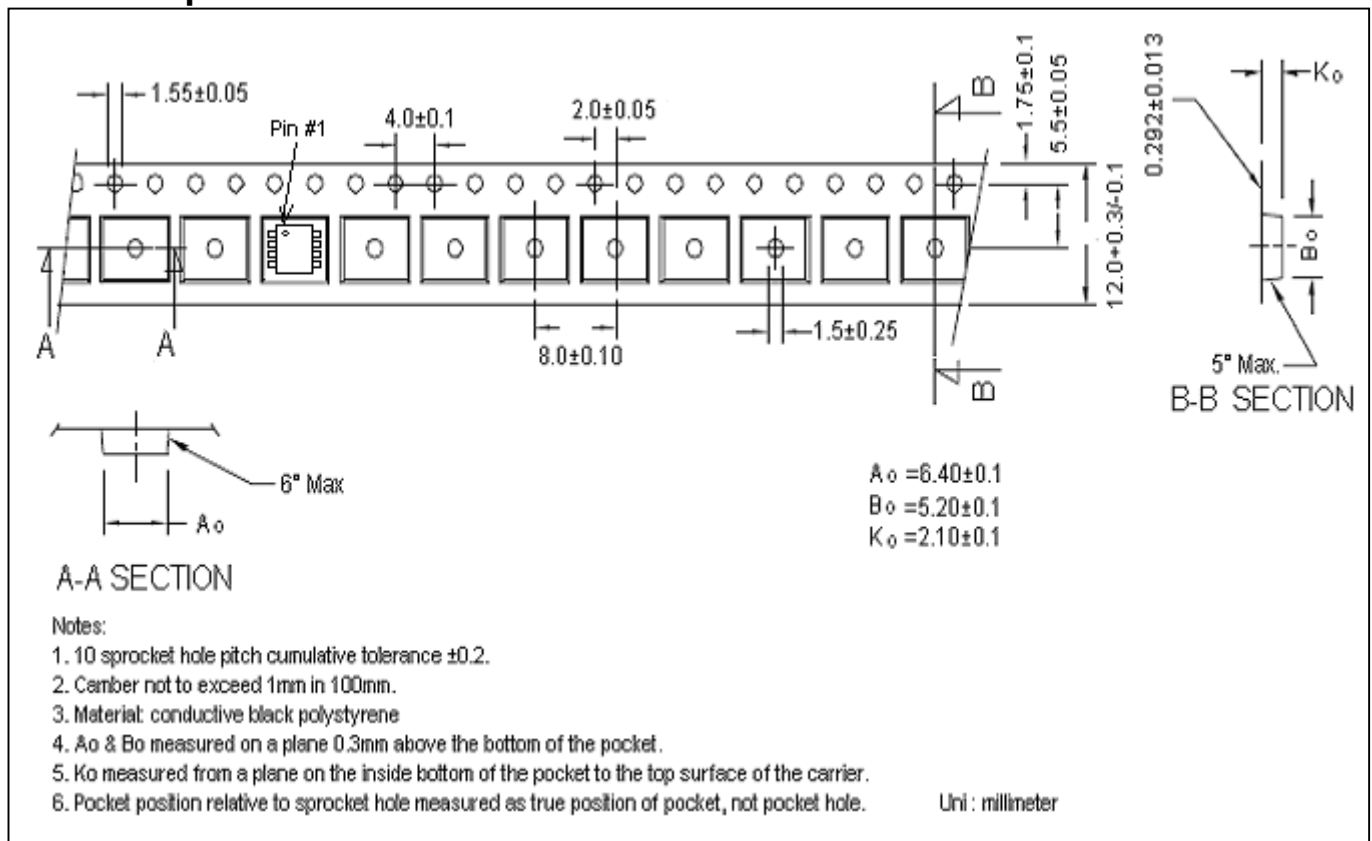

Fig 12. Gate Charge Waveform

Reel Dimension



Carrier Tape Dimension



Recommended wave soldering condition

Product	Peak Temperature	Soldering Time
Pb-free devices	260 +0/-5 °C	5 +1/-1 seconds

Recommended temperature profile for IR reflow

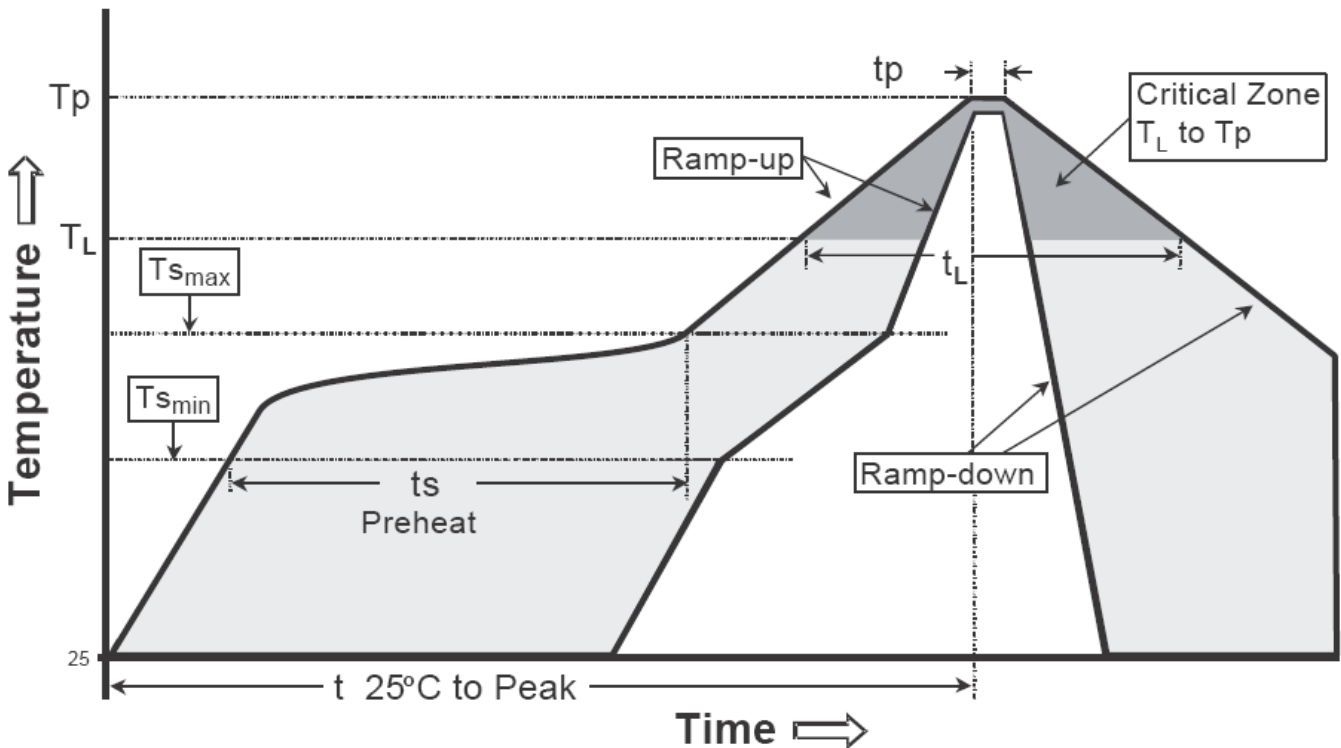

Profile feature	Sn-Pb eutectic Assembly	Pb-free Assembly
Average ramp-up rate (Tsmax to Tp)	3°C/second max.	3°C/second max.
Preheat		
-Temperature Min(Ts min)	100°C	150°C
-Temperature Max(Ts max)	150°C	200°C
-Time(ts min to ts max)	60-120 seconds	60-180 seconds
Time maintained above:		
-Temperature (TL)	183°C	217°C
- Time (tL)	60-150 seconds	60-150 seconds
Peak Temperature(TP)	240 +0/-5 °C	260 +0/-5 °C
Time within 5°C of actual peak temperature(tp)	10-30 seconds	20-40 seconds
Ramp down rate	6°C/second max.	6°C/second max.
Time 25 °C to peak temperature	6 minutes max.	8 minutes max.

Note : All temperatures refer to topside of the package, measured on the package body surface.

SOP-8 Dimension

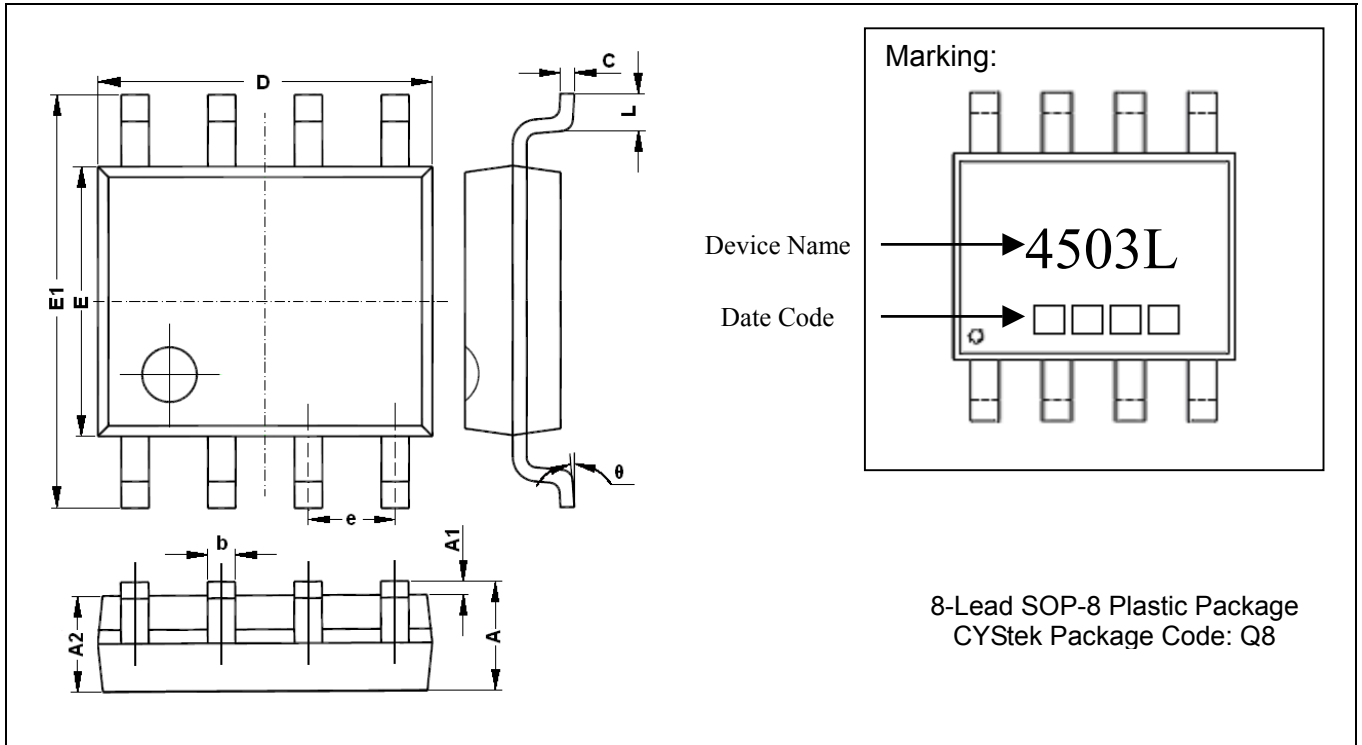

DIM	Millimeters		Inches		DIM	Millimeters		Inches	
	Min.	Max.	Min.	Max.		Min.	Max.	Min.	Max.
A	1.350	1.750	0.053	0.069	E	3.800	4.000	0.150	0.157
A1	0.100	0.250	0.004	0.010	E1	5.800	6.200	0.228	0.244
A2	1.350	1.550	0.053	0.061	e	1.270	(BSC)	0.050	(BSC)
b	0.330	0.510	0.013	0.020	L	0.400	1.270	0.016	0.050
c	0.170	0.250	0.006	0.010	θ	0	8°	0	8°
D	4.700	5.100	0.185	0.200					

Notes: 1.Controlling dimension: millimeters.
 2.Maximum lead thickness includes lead finish thickness, and minimum lead thickness is the minimum thickness of base material.
 3.If there is any question with packing specification or packing method, please contact your local CYStek sales office.

Material:

- Lead: Pure tin plated.
- Mold Compound: Epoxy resin family, flammability solid burning class: UL94V-0.

Important Notice:

- All rights are reserved. Reproduction in whole or in part is prohibited without the prior written approval of CYStek.
- CYStek reserves the right to make changes to its products without notice.
- CYStek **semiconductor products are not warranted to be suitable for use in Life-Support Applications, or systems.**
- CYStek assumes no liability for any consequence of customer product design, infringement of patents, or application assistance.