

Dual P-Channel Enhancement Mode Power MOSFET

MTDP9933KQ8

BVDSS	-20V
ID@VGS=-4.5V, TA=25°C	-4.5A
ID@VGS=-4.5V, TC=25°C	-7.5A
RDSON@VGS=-4.5V, ID=-4A	28 mΩ (typ)
RDSON@VGS=-2.5V, ID=-4A	36 mΩ (typ)
RDSON@VGS=-1.8V, ID=-2A	44 mΩ (typ)

Features

- Simple drive requirement
- Low on-resistance
- Fast switching speed
- Pb-free lead plating and halogen-free package
- ESD protected device

Equivalent Circuit

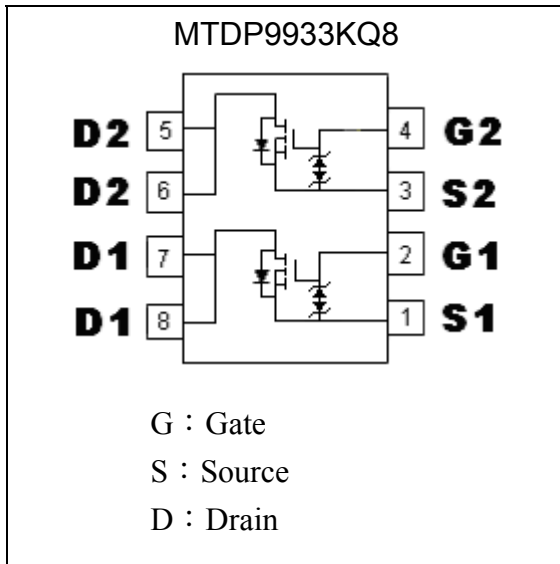

Outline

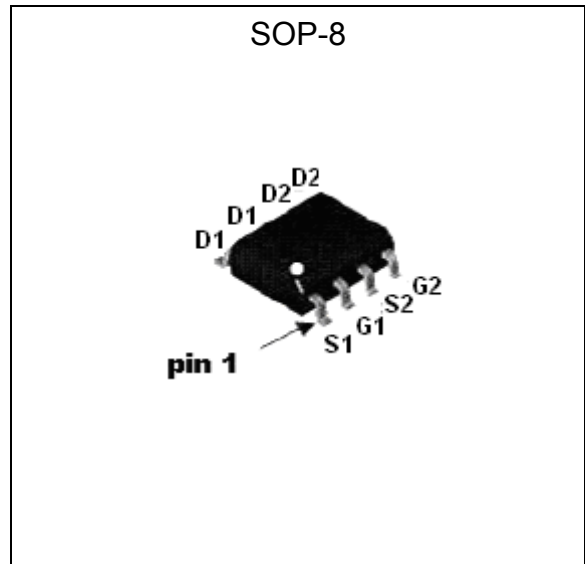

Ordering Information

Device	Package	Shipping
MTDP9933KQ8-0-T3-G	SOP-8 (Pb-free lead plating and halogen-free package)	2500 pcs / tape & reel

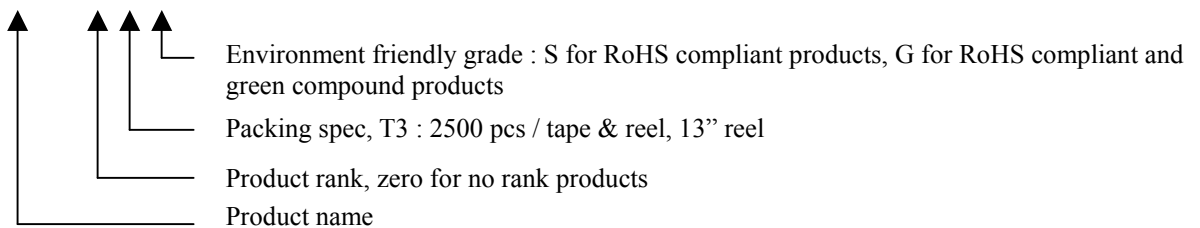



Absolute Maximum Ratings (Ta=25°C)

Parameter		Symbol	10s	Steady State	Unit	
Drain-Source Voltage		V _{DS}	-20		V	
Gate-Source Voltage		V _{GS}	±8			
Continuous Drain Current @ T _C =25°C, V _{GS} =-4.5V (Note1)		I _D	-7.5		A	
Continuous Drain Current @ T _C =100°C, V _{GS} =-4.5V (Note1)			-4.7			
Continuous Drain Current @ T _A =25°C, V _{GS} =-4.5V (Note2)		I _{DSM}	-6.0	-4.5		
Continuous Drain Current @ T _A =70°C, V _{GS} =-4.5V (Note2)			-4.8	-3.6		
Pulsed Drain Current (Note3)		I _{DM}	-40 *1,2			
Total Power Dissipation	T _C =25°C (Note1)	P _D	3.1			W
	T _C =100°C (Note1)		1.2			
	T _A =25°C (Note2)	P _{DSM}	2.0	1.1		
	T _A =70°C (Note2)		1.3	0.7		
Operating Junction and Storage Temperature Range		T _J , T _{stg}	-55~+150		°C	

Thermal Data

Parameter	Symbol	Typical	Maximum	Unit
Thermal Resistance, Junction-to-case	R _{th,j-c}	34	40	°C/W
Thermal Resistance, Junction-to-ambient (Note2)	R _{th,j-a}	t≤10s	58	
		Steady State	91	

- Note : 1.The power dissipation P_D is based on T_{J(MAX)}=150°C, using junction-to-case thermal resistance, and is more useful in setting the upper dissipation limit for cases where additional heatsinking is used.
2. The value of R_{θJA} is measured with the device mounted on 1 in² FR-4 board with 2 oz. copper, in a still air environment with T_A=25°C. The power dissipation P_{DSM} is based on R_{θJA} and the maximum allowed junction temperature of 150°C. The value in any given application depends on the user's specific board design.
3. Repetitive rating, pulse width limited by junction temperature T_{J(MAX)}=150°C. Ratings are based on low frequency and low duty cycles to keep initial T_J=25°C.

Electrical Characteristics (Tc=25°C, unless otherwise noted)

Symbol	Min.	Typ.	Max.	Unit	Test Conditions
Static					
BV _{DSS}	-20	-	-	V	V _{GS} =0V, I _D =-250μA
V _{GS(th)}	-0.3	-	-0.9		V _{DS} =V _{GS} , I _D =-250μA
I _{GSS}	-	-	±10	μA	V _{GS} =±8V, V _{DS} =0V
I _{DSS}	-	-	-1		V _{DS} =-20V, V _{GS} =0V
I _{DSS}	-	-	-5		V _{DS} =-20V, V _{GS} =0, T _J =55°C
R _{DS(ON)} (Note 1)	-	28	38		mΩ
	-	36	48	I _D =-4A, V _{GS} =-2.5V	
	-	44	62	I _D =-2A, V _{GS} =-1.8V	
G _{FS} (Note 1)	-	30	-	S	V _{DS} =-5V, I _D =-3A

Dynamic					
Ciss	-	828	1242	pF	V _{DS} =-10V, V _{GS} =0, f=1MHz
Coss	-	134	201		
Crss	-	127	191		
t _{d(ON)} (Note 1&2)	-	4.2	6.3	ns	V _{DS} =-5V, I _D =-0.5A, V _{GS} =-4.5V, R _G =6Ω
t _r (Note 1&2)	-	23.6	35.4		
t _{d(OFF)} (Note 1&2)	-	54.6	81.9		
t _f (Note 1&2)	-	28.8	43.2		
Q _g (Note 1&2)	-	10.6	15.9	nC	V _{DS} =-10V, I _D =-3.8A, V _{GS} =-4.5V
Q _{gs} (Note 1&2)	-	1.2	-		
Q _{gd} (Note 1&2)	-	3.9	-		
R _g	-	5.8	-	Ω	f=1MHz
Source-Drain Diode					
I _S	-	-	-1.7	A	
I _{SM} (Note 3)	-	-	-10		
V _{SD} (Note 1)	-	-0.76	-1	V	I _S =-1A, V _{GS} =0V
t _{rr}	-	22.3	-	ns	I _F =-1.3A, dI _F /dt=100A/μs
Q _{rr}	-	4.4	-	nC	

Note : 1.Pulse Test : Pulse Width ≤300μs, Duty Cycle≤2%
 2.Independent of operating temperature
 3.Pulse width limited by maximum junction temperature

Recommended Soldering Footprint

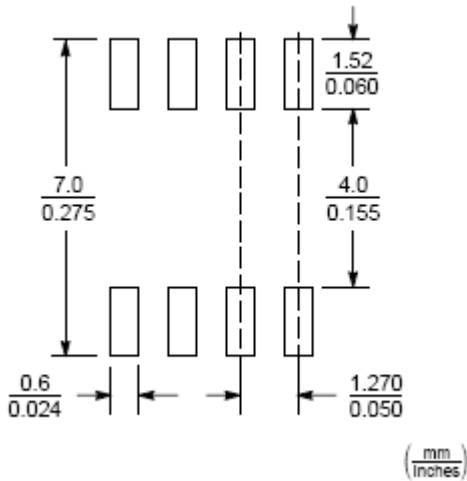

Typical Characteristics

Typical Output Characteristics

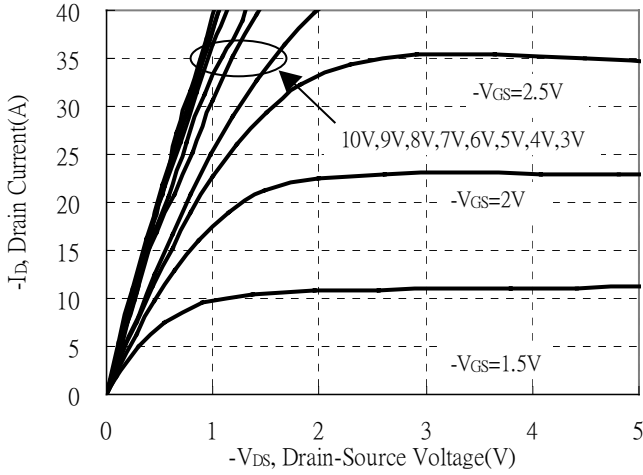

Breakdown Voltage vs Ambient Temperature

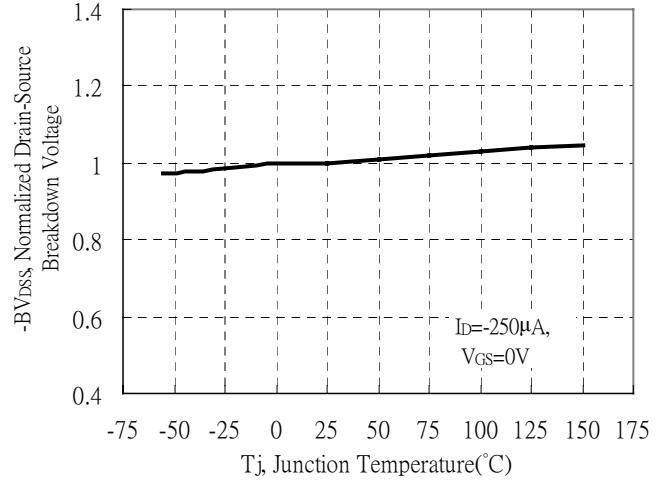

Static Drain-Source On-State resistance vs Drain Current

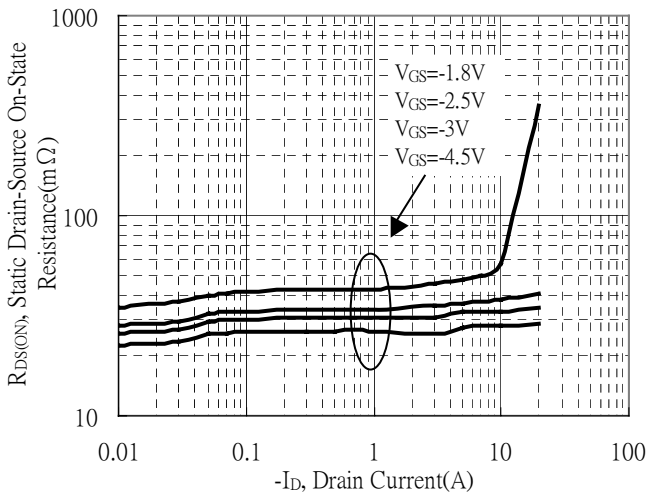

Reverse Drain Current vs Source-Drain Voltage

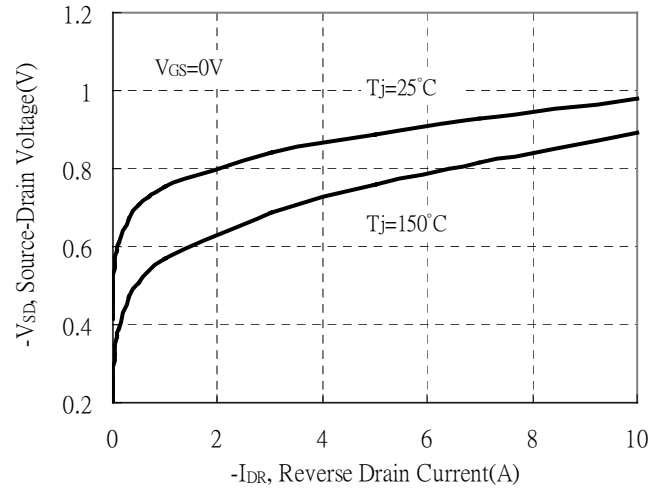

Static Drain-Source On-State Resistance vs Gate-Source Voltage

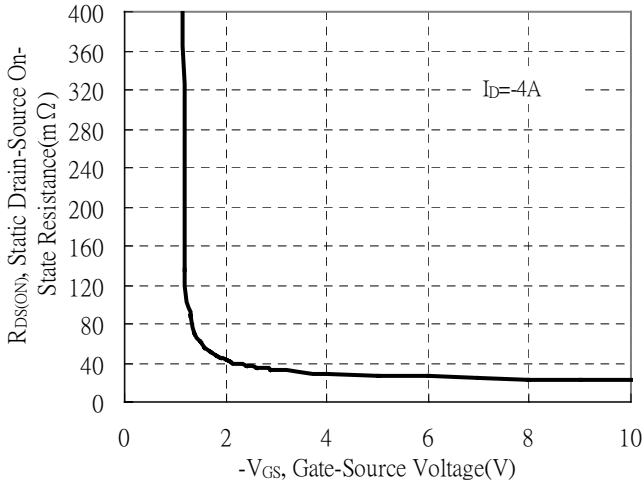

Drain-Source On-State Resistance vs Junction Temperature

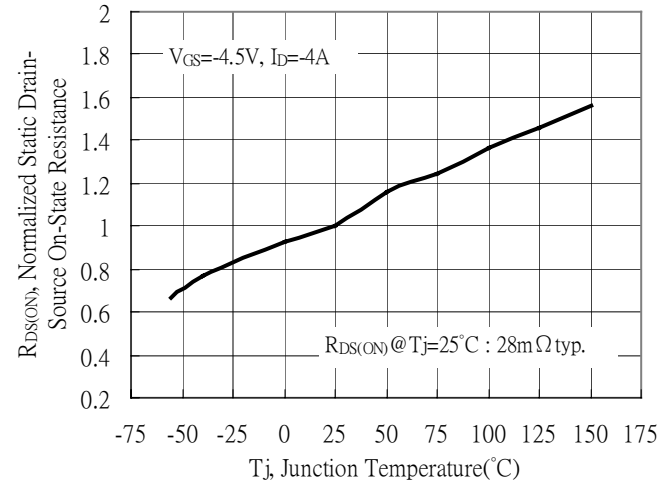

Typical Characteristics(Cont.)

Capacitance vs Drain-to-Source Voltage

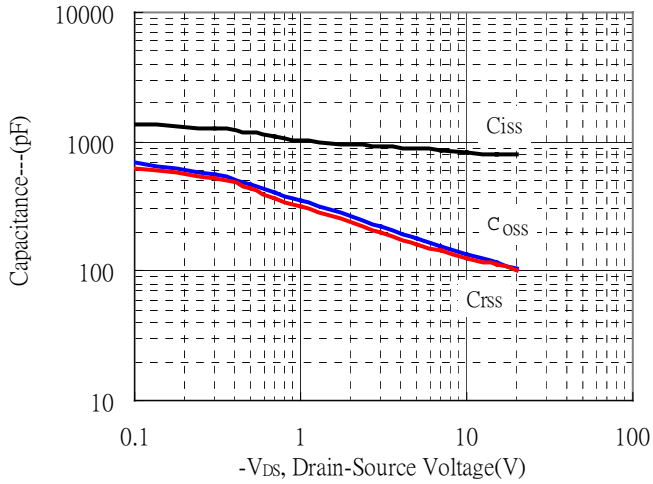

Threshold Voltage vs Junction Temperature

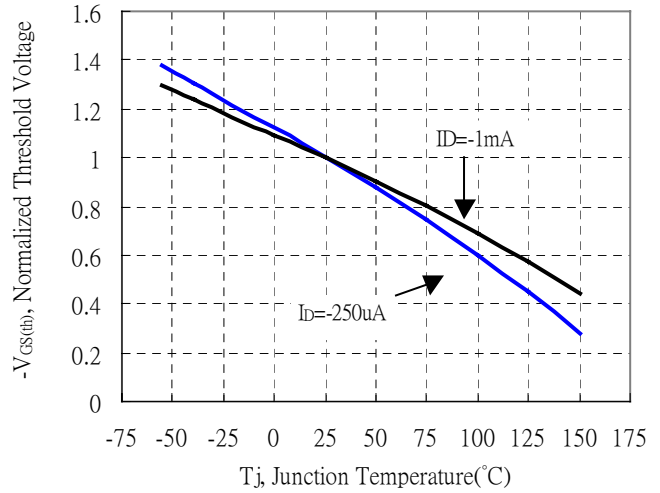

Maximum Safe Operating Area

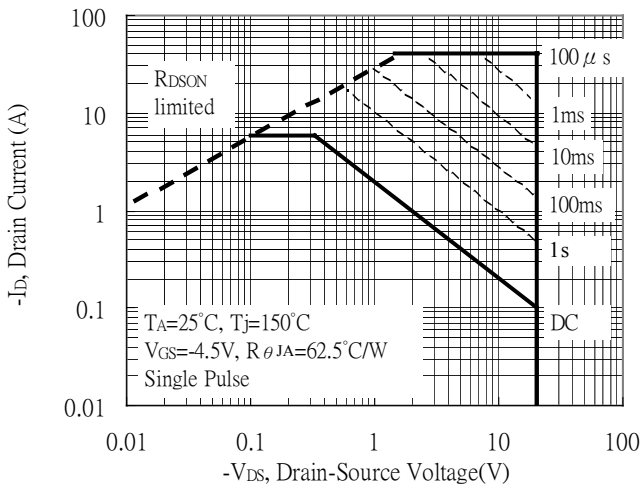

Gate Charge Characteristics

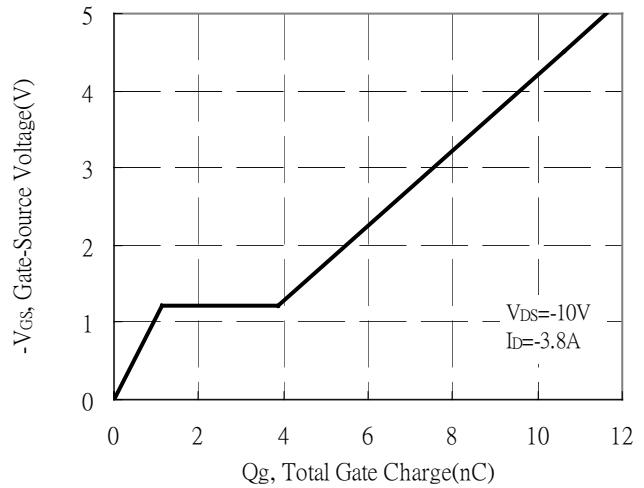

Maximum Drain Current vs Junction Temperature

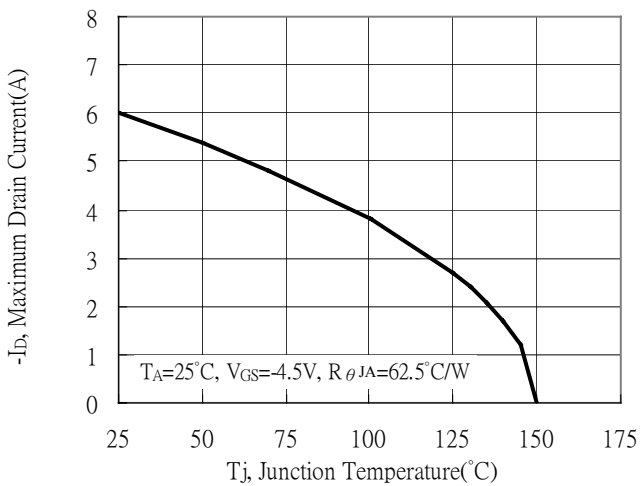

Forward Transfer Admittance vs Drain Current

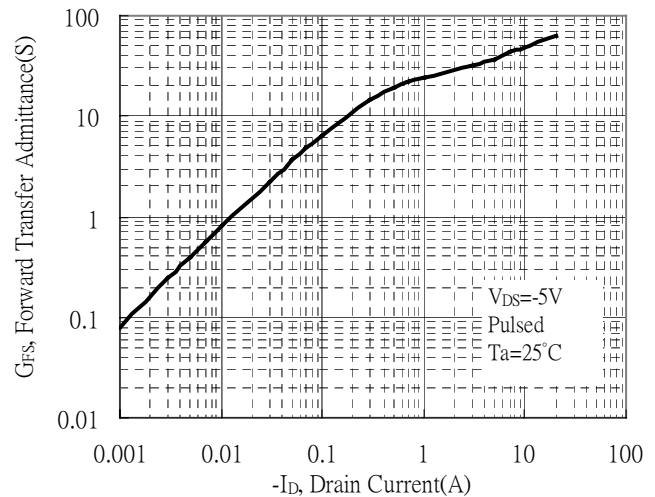

Typical Characteristics(Cont.)

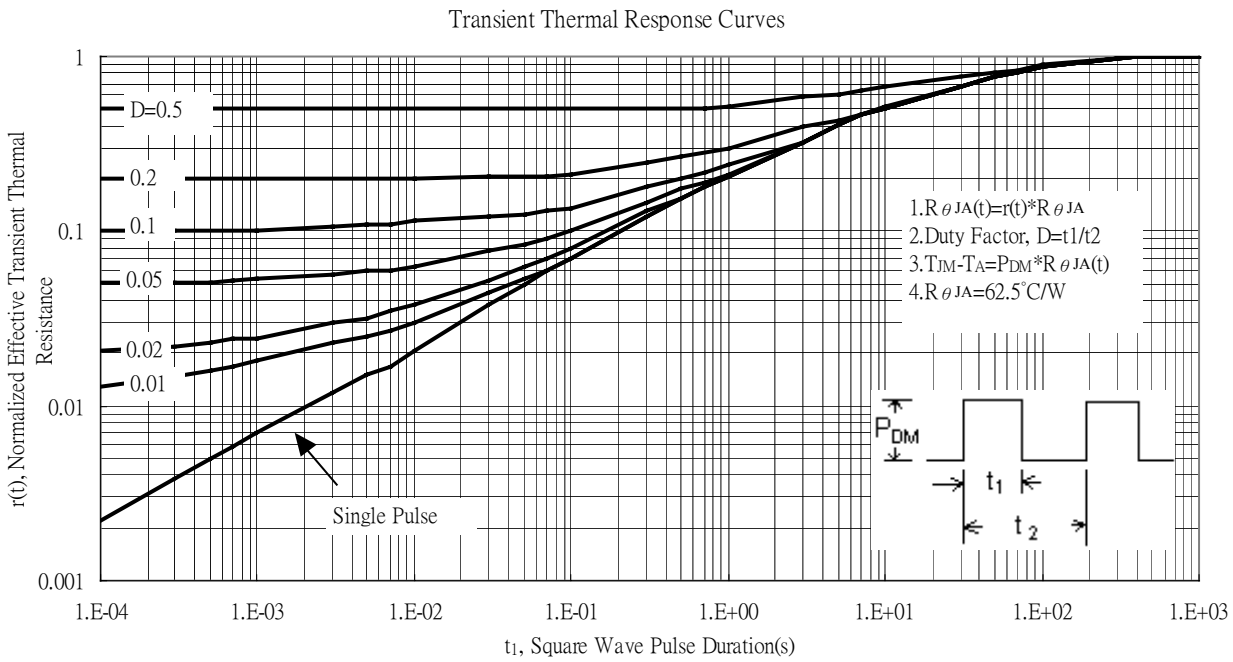
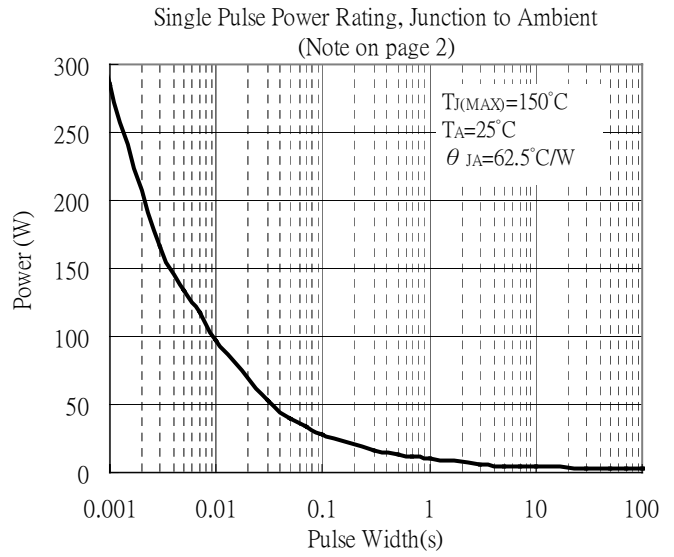
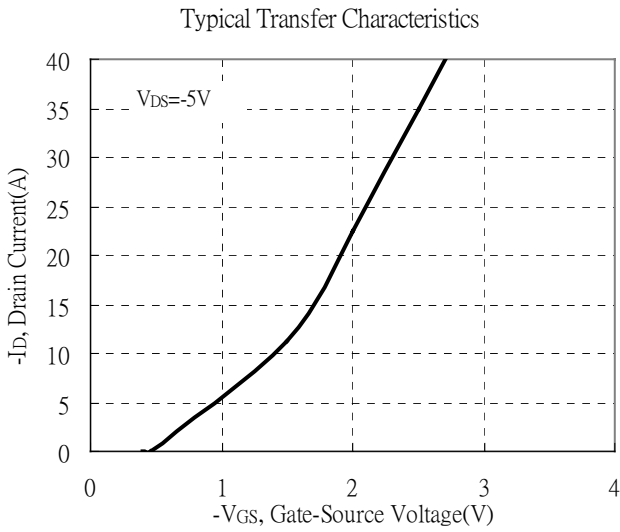

Reel Dimension

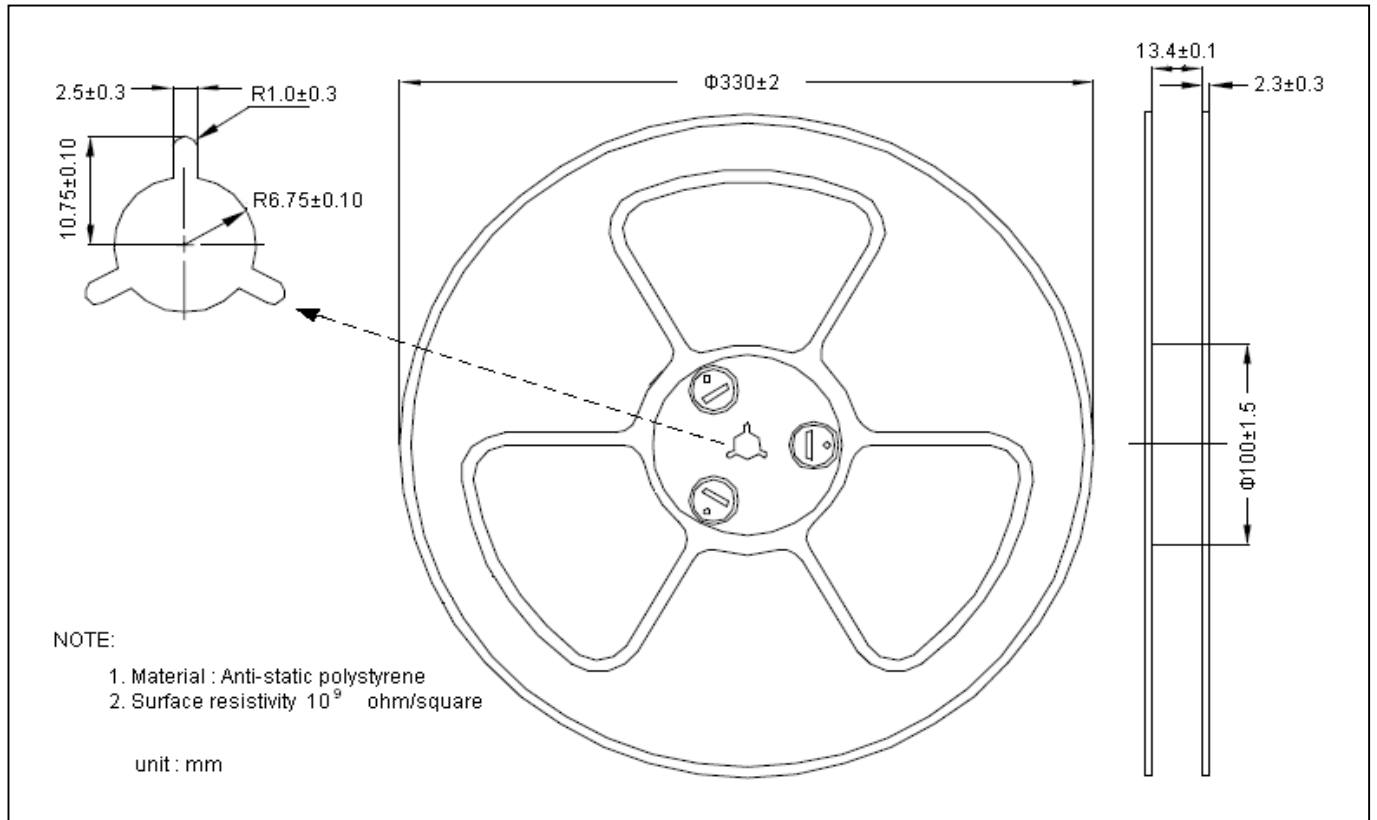

Carrier Tape Dimension

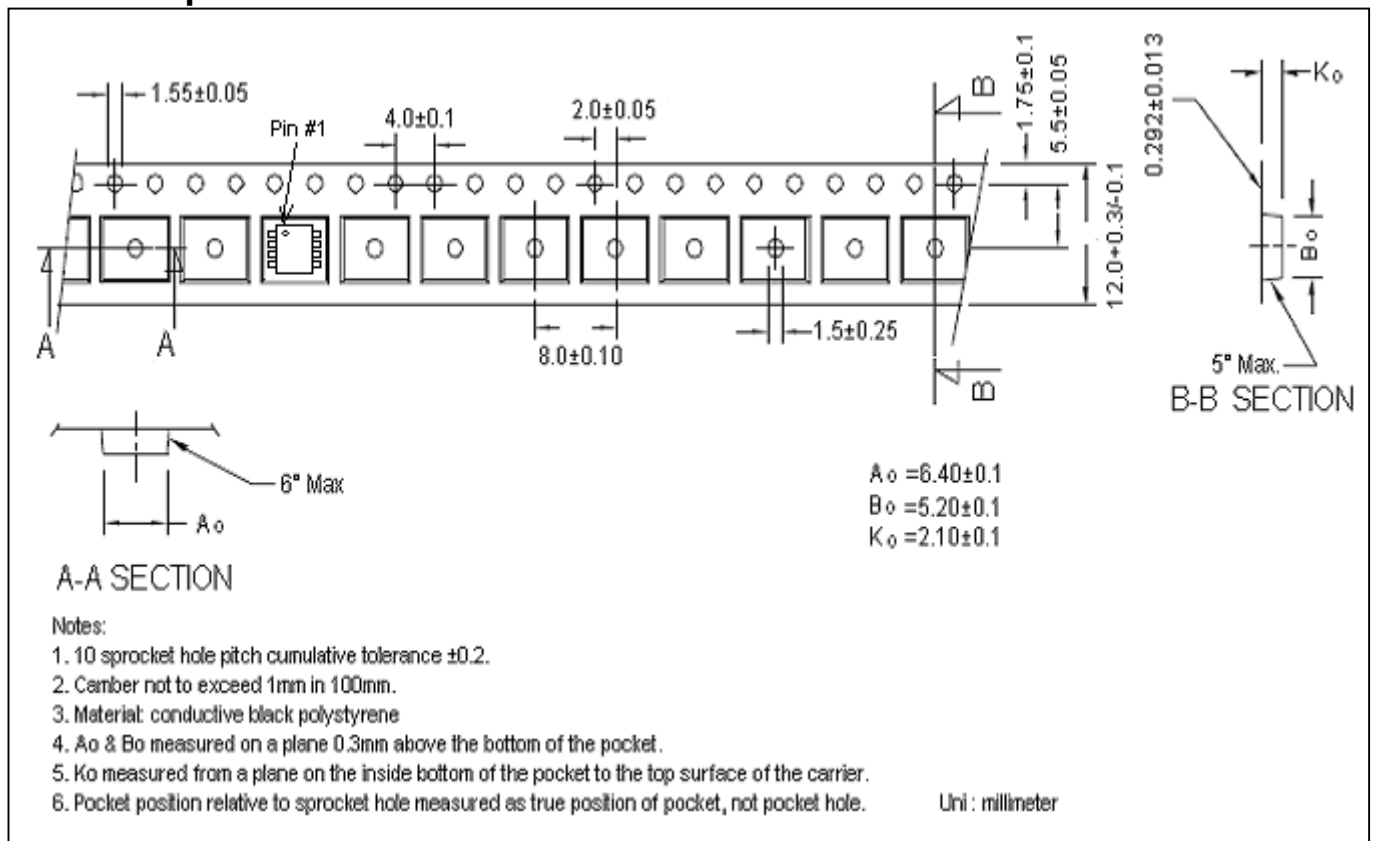

Recommended wave soldering condition

Product	Peak Temperature	Soldering Time
Pb-free devices	260 +0/-5 °C	5 +1/-1 seconds

Recommended temperature profile for IR reflow

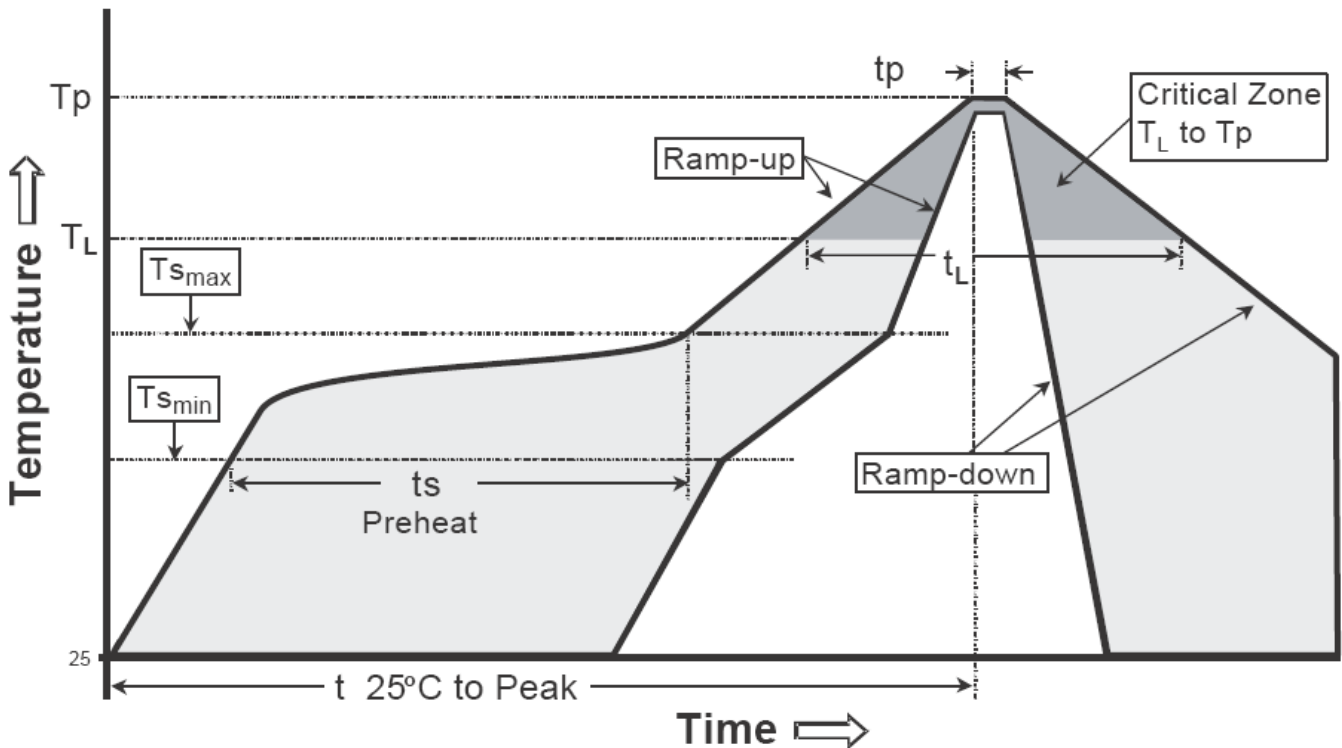

Profile feature	Sn-Pb eutectic Assembly	Pb-free Assembly
Average ramp-up rate (T _{smax} to T _p)	3°C/second max.	3°C/second max.
Preheat		
-Temperature Min(T _{s min})	100°C	150°C
-Temperature Max(T _{s max})	150°C	200°C
-Time(t _{s min} to t _{s max})	60-120 seconds	60-180 seconds
Time maintained above:		
-Temperature (T _L)	183°C	217°C
- Time (t _L)	60-150 seconds	60-150 seconds
Peak Temperature(T _p)	240 +0/-5 °C	260 +0/-5 °C
Time within 5°C of actual peak temperature(tp)	10-30 seconds	20-40 seconds
Ramp down rate	6°C/second max.	6°C/second max.
Time 25 °C to peak temperature	6 minutes max.	8 minutes max.

Note : All temperatures refer to topside of the package, measured on the package body surface.

SOP-8 Dimension

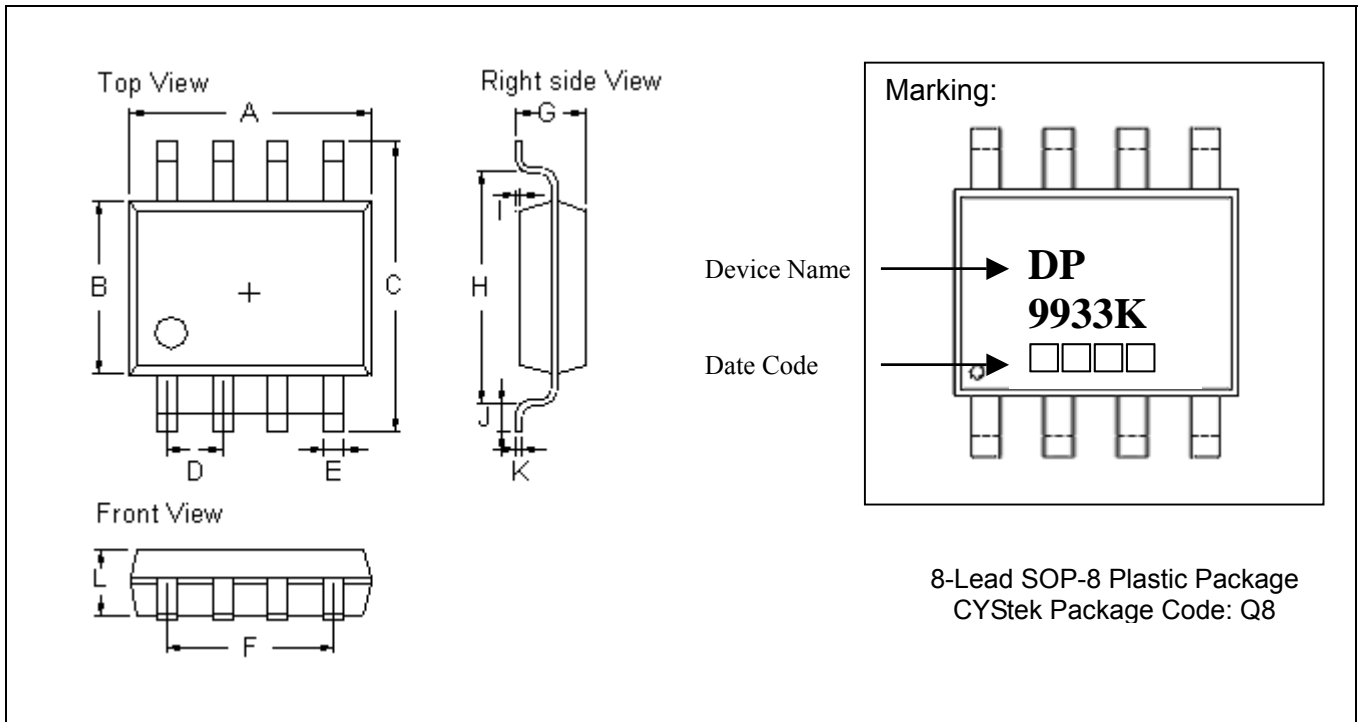

*: Typical

DIM	Inches		Millimeters		DIM	Inches		Millimeters	
	Min.	Max.	Min.	Max.		Min.	Max.	Min.	Max.
A	0.1850	0.2007	4.70	5.10	G	0.0531	0.0689	1.35	1.75
B	0.1496	0.1575	3.80	4.00	H	0.1889	0.2007	4.80	5.10
C	0.2283	0.2441	5.80	6.20	I	0.0019	0.0098	0.05	0.25
D	0.0500*		1.27 *		J	0.0157	0.0500	0.40	1.27
E	0.0130	0.0201	0.33	0.51	K	0.0067	0.0098	0.17	0.25
F	0.1472	0.1527	3.74	3.88	L	0.0531	0.0610	1.35	1.55

Notes: 1.Controlling dimension: millimeters.
 2.Maximum lead thickness includes lead finish thickness, and minimum lead thickness is the minimum thickness of base material.
 3.If there is any question with packing specification or packing method, please contact your local CYStek sales office.

Material:

- Lead: Pure tin plated.
- Mold Compound: Epoxy resin family, flammability solid burning class: UL94V-0.

Important Notice:

- All rights are reserved. Reproduction in whole or in part is prohibited without the prior written approval of CYStek.
- CYStek reserves the right to make changes to its products without notice.
- CYStek **semiconductor products are not warranted to be suitable for use in Life-Support Applications, or systems.**
- CYStek assumes no liability for any consequence of customer product design, infringement of patents, or application assistance.