

PNP Transistors

2SB1025-HF

■ Features

- Low frequency power amplifier
- Complementary to 2SD1418-HF
- Pb-Free Package May be Available. The G-Suffix Denotes a Pb-Free Lead Finish

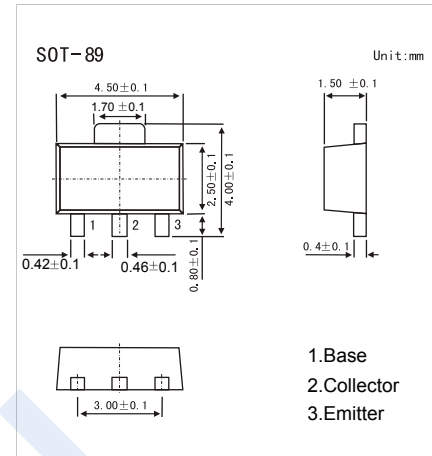

■ Absolute Maximum Ratings Ta = 25°C

Parameter	Symbol	Rating	Unit
Collector - Base Voltage	V _{CB0}	-120	V
Collector - Emitter Voltage	V _{CE0}	-80	
Emitter - Base Voltage	V _{EB0}	-5	
Collector Current - Continuous	I _C	-1	A
Collector current -Pulse (Note.1)	I _{CP}	-2	
Collector Power Dissipation	P _C	1	W
Junction Temperature	T _J	150	°C
Storage Temperature range	T _{stg}	-55 to 150	

Note.1: PW ≤ 10ms,Duty cycle ≤ 20%

■ Electrical Characteristics Ta = 25°C

Parameter	Symbol	Test Conditions	Min	Typ	Max	Unit
Collector- base breakdown voltage	V _{CB0}	I _C = -100 μA, I _E =0	-120			V
Collector- emitter breakdown voltage	V _{CE0}	I _C = -1 mA, R _{BE} =∞	-80			
Emitter - base breakdown voltage	V _{EB0}	I _E = -100 μA, I _C =0	-5			
Collector-base cut-off current	I _{CB0}	V _{CB} = -100V, I _E =0			-10	uA
Emitter cut-off current	I _{EB0}	V _{EB} = -5V, I _C =0			-0.1	
Collector-emitter saturation voltage	V _{CE(sat)}	I _C =-500mA, I _B =-50mA			-1	V
Base - emitter saturation voltage	V _{BE(sat)}	I _C =-500mA, I _B =-50mA			-1.2	
Base - emitter voltage	V _{BE}	V _{CE} = -5V, I _C = -150 mA			-0.9	
DC current gain	h _{FE}	V _{CE} = -5V, I _C = -150 mA	60		320	
		V _{CE} = -5V, I _C = -500 mA	30			
Collector output capacitance	C _{ob}	V _{CB} = -10V, I _E = 0, f = 1MHz		20		pF
Transition frequency	f _T	V _{CE} = -5V, I _C = -150mA		140		MHz

■ Classification of h_{FE}(1)

Type	2SB1025-H-HF	2SB1025-J-HF	2SB1025-K-HF
Range	60-120	100-200	160-320
Marking	DH _F	DJ _F	DK _F

PNP Transistors

2SB1025-HF

Typical Characteristics

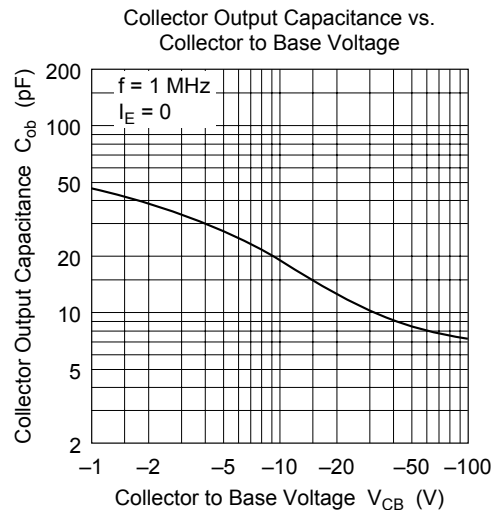
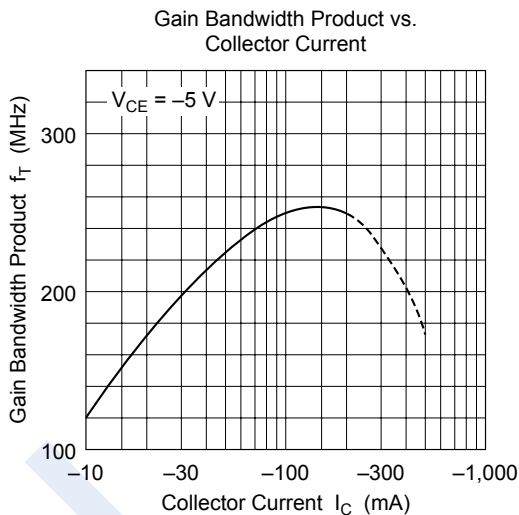
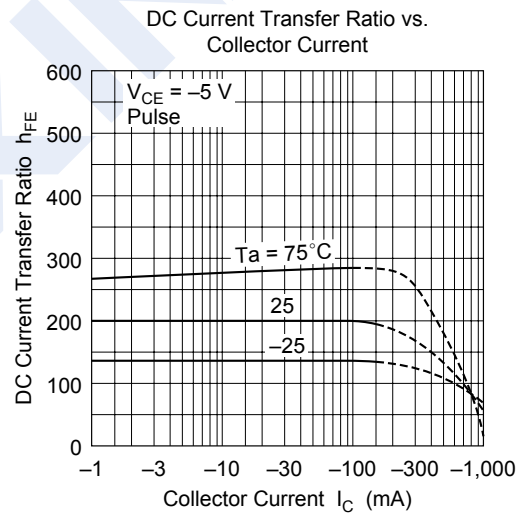
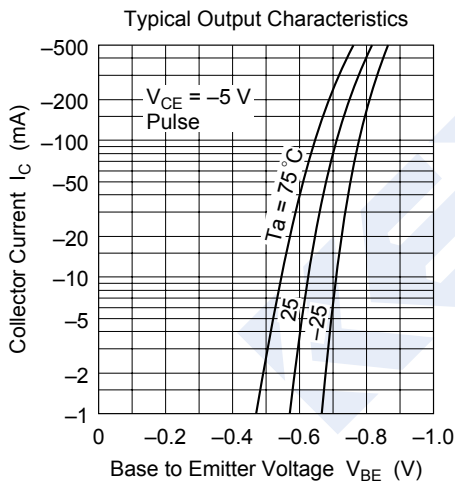
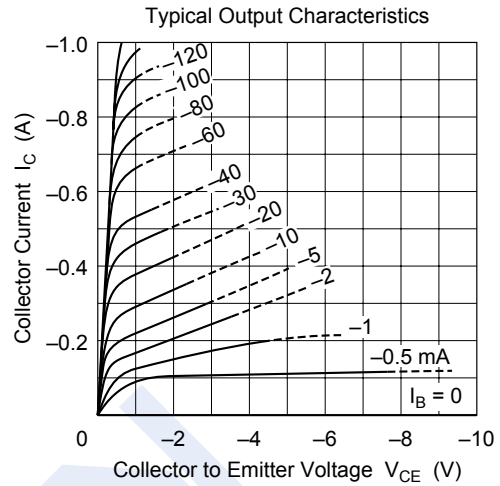
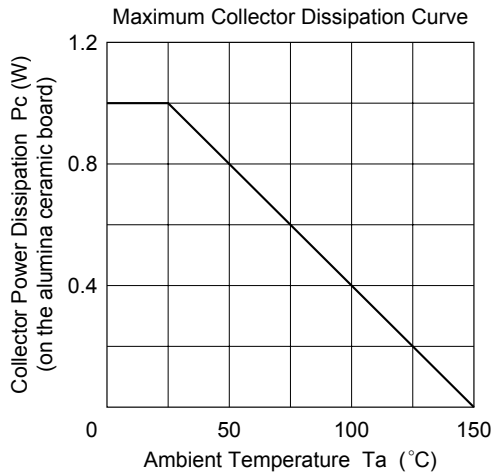

PNP Transistors

2SB1025-HF

■ Typical Characteristics

