

General Purpose NPN Epitaxial Planar Transistor

BTD5213L3

Description

General purpose mainly intended for use in medium power industrial application and for audio amplifier output stage.

Features

- High collector current and low $V_{CE(SAT)}$.
- Complement to BTB5213L3.
- Pb-free lead plating and halogen-free package.

Symbol

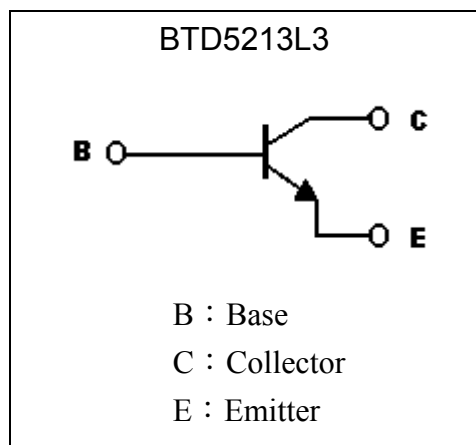

Outline



Ordering Information

Device	Package	Shipping
BTD5213L3-0-T3-G	SOT-223 (Pb-free lead plating and halogen-free package)	2500 pcs / tape & reel

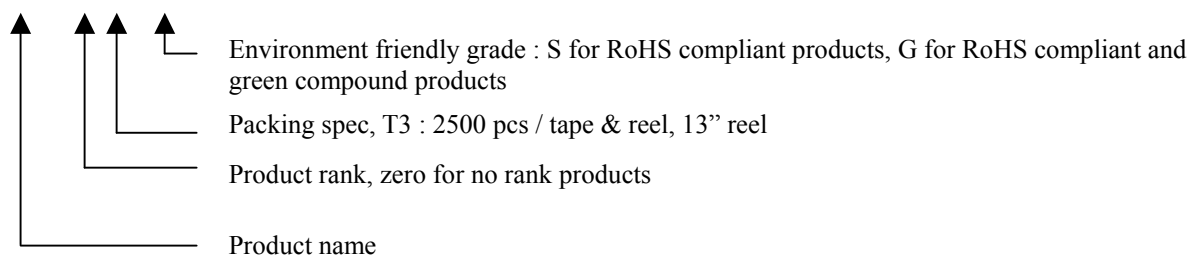



Absolute Maximum Ratings (Ta=25°C)

Parameter	Symbol	Limits	Unit
Collector-Base Voltage	V _{CB0}	180	V
Collector-Emitter Voltage	V _{CEO}	100	V
Emitter-Base Voltage	V _{EB0}	5	V
Collector Current(DC)	I _C	1	A
Collector Current(Pulse)	I _{CP}	1.5	A
Power Dissipation @T _c =25°C	P _d	2	W
Junction Temperature	T _j	150	°C
Storage Temperature	T _{stg}	-55~+150	°C

Characteristics (Ta=25°C)

Symbol	Min.	Typ.	Max.	Unit	Test Conditions
BV _{CB0}	180	-	-	V	I _C =100μA
BV _{CEO}	100	-	-	V	I _C =10mA
BV _{EB0}	5	-	-	V	I _E =10μA
I _{CB0}	-	-	100	nA	V _{CB} =80V
I _{EB0}	-	-	100	nA	V _{EB} =5V
*V _{CE(sat)1}	-	0.15	0.3	V	I _C =500mA, I _B =50mA
*V _{CE(sat)2}	-	-	0.6	V	I _C =1A, I _B =50mA
*V _{BE(sat)}	-	-	1.2	V	I _C =1A, I _B =50mA
*V _{BE(on)}	-	-	1.0	V	V _{CE} =2V, I _C =500mA
*h _{FE1}	200	-	-	-	V _{CE} =2V, I _C =5mA
*h _{FE2}	200	-	400	-	V _{CE} =2V, I _C =150mA
*h _{FE3}	60	-	-	-	V _{CE} =2V, I _C =500mA
f _T	-	125	-	MHz	V _{CE} =10V, I _C =50mA, f=100MHz
C _{ob}	-	-	10	pF	V _{CB} =10V, I _E =0A, f=1MHz

*Pulse Test: Pulse Width ≤380μs, Duty Cycle≤2%



Typical Characteristics

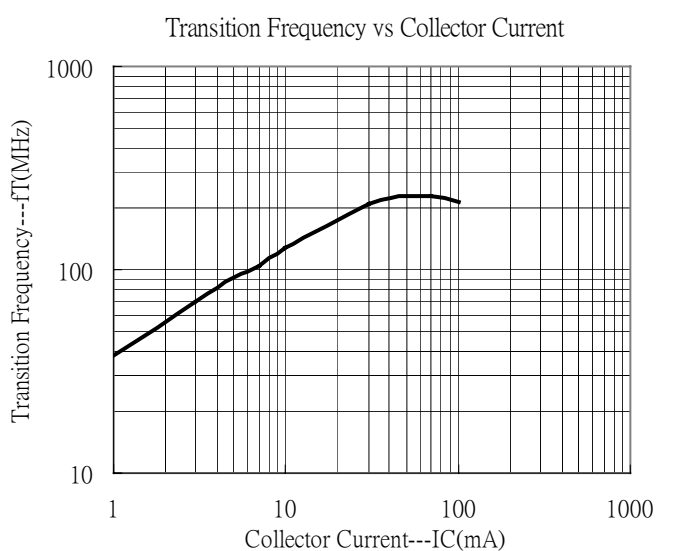
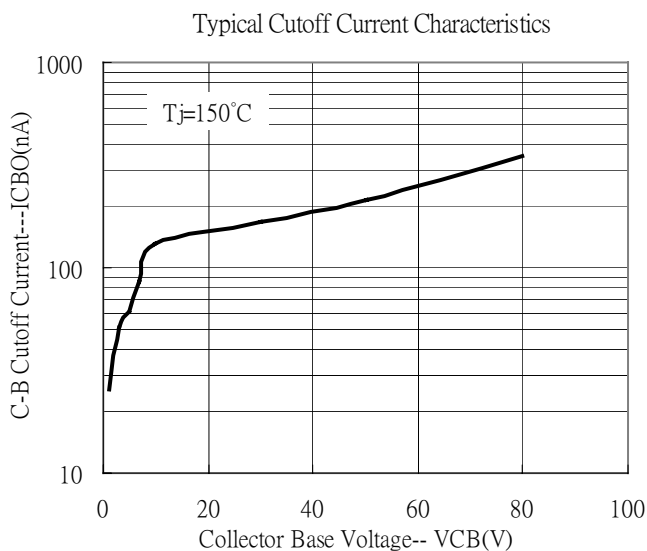
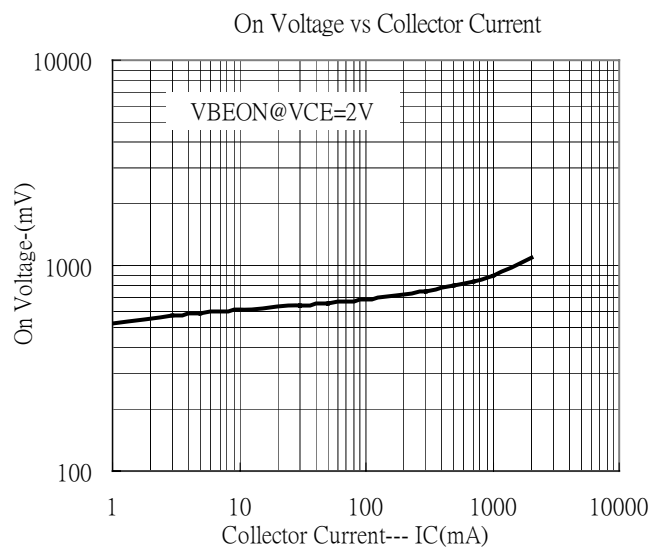
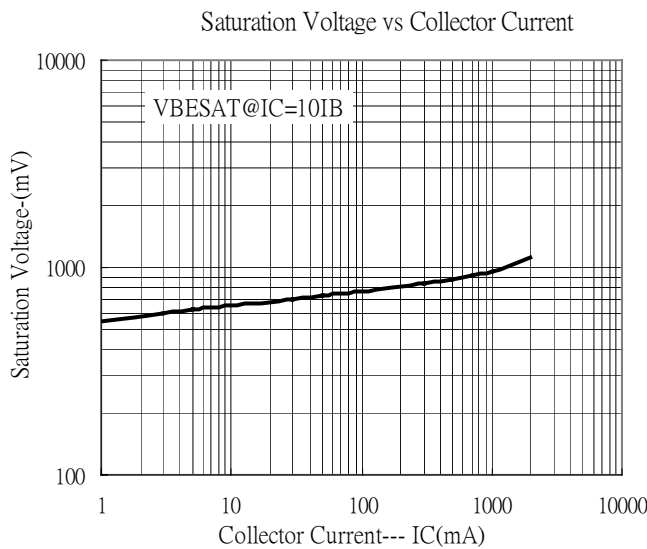
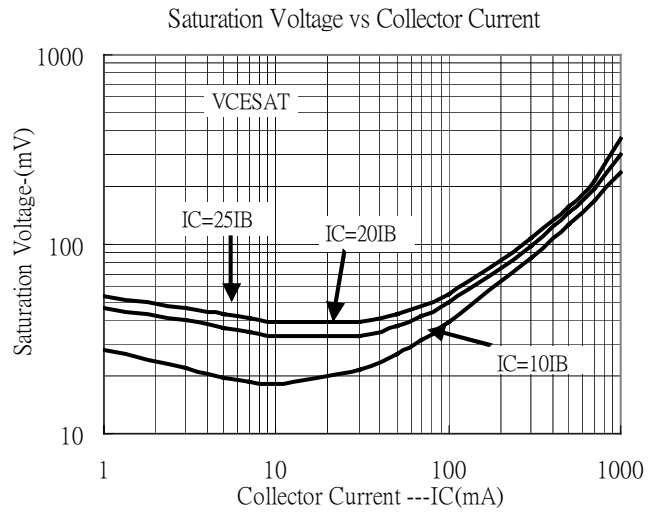
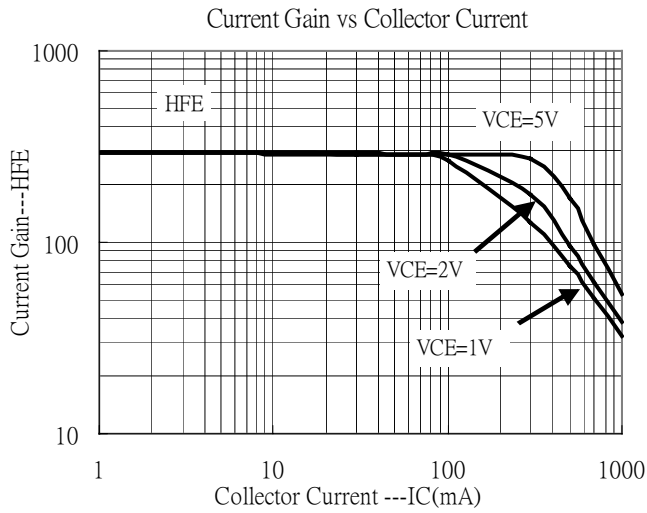

Typical Characteristics(Cont.)

Power Derating Curve

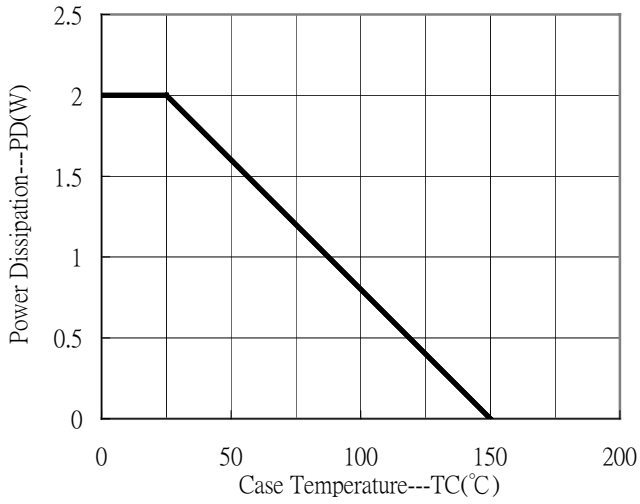

Recommended soldering footprint

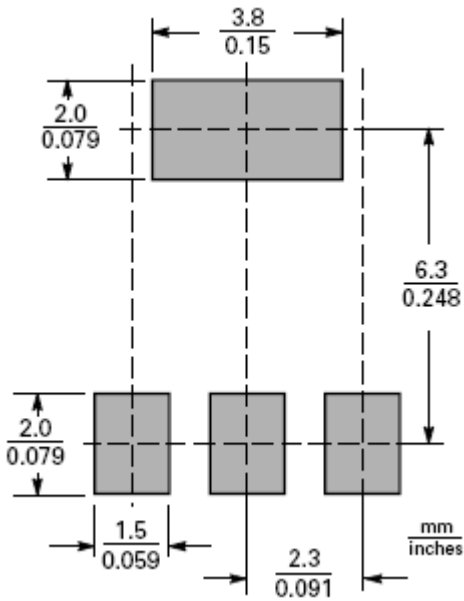

Reel Dimension

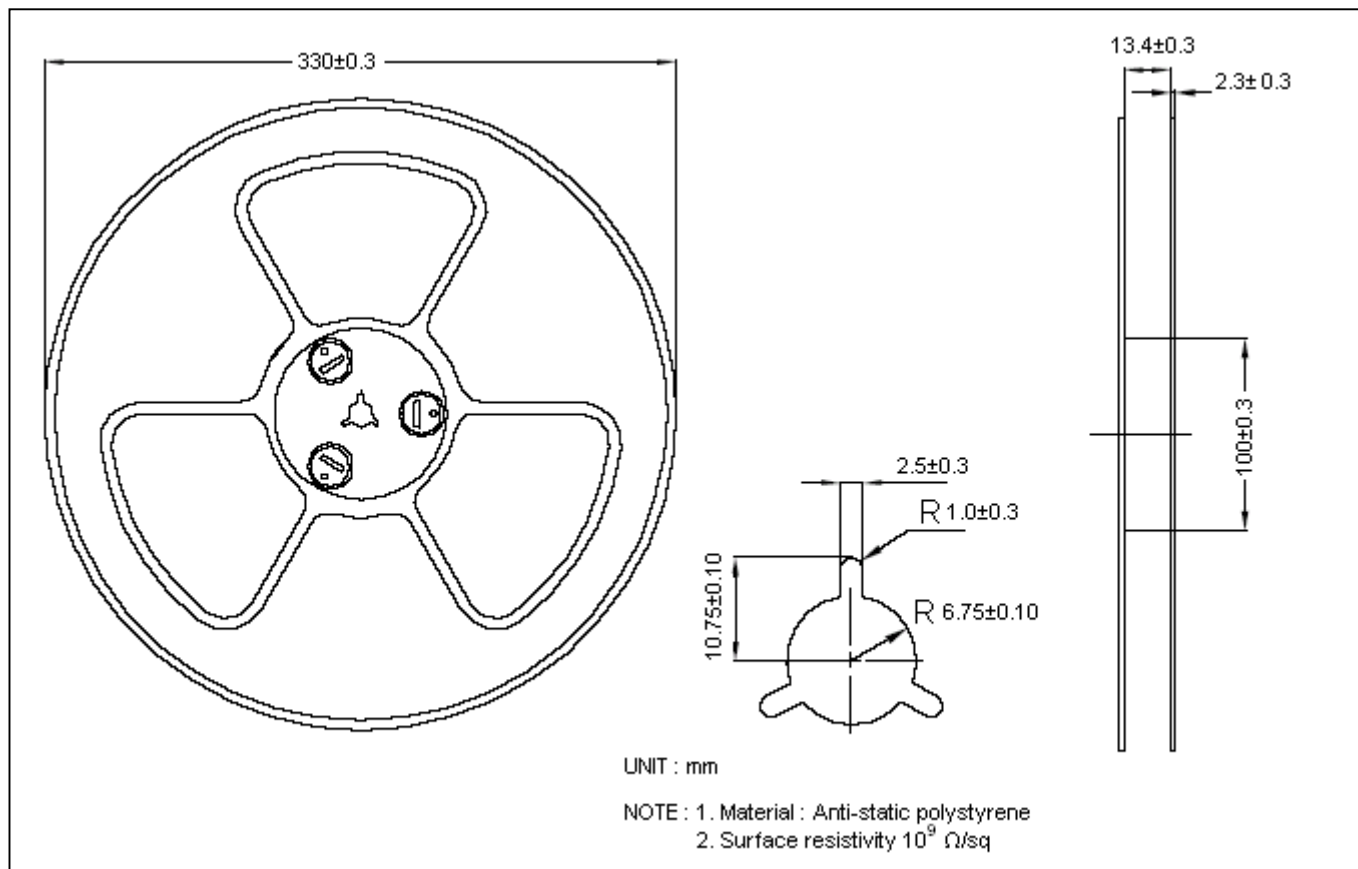

Carrier Tape Dimension

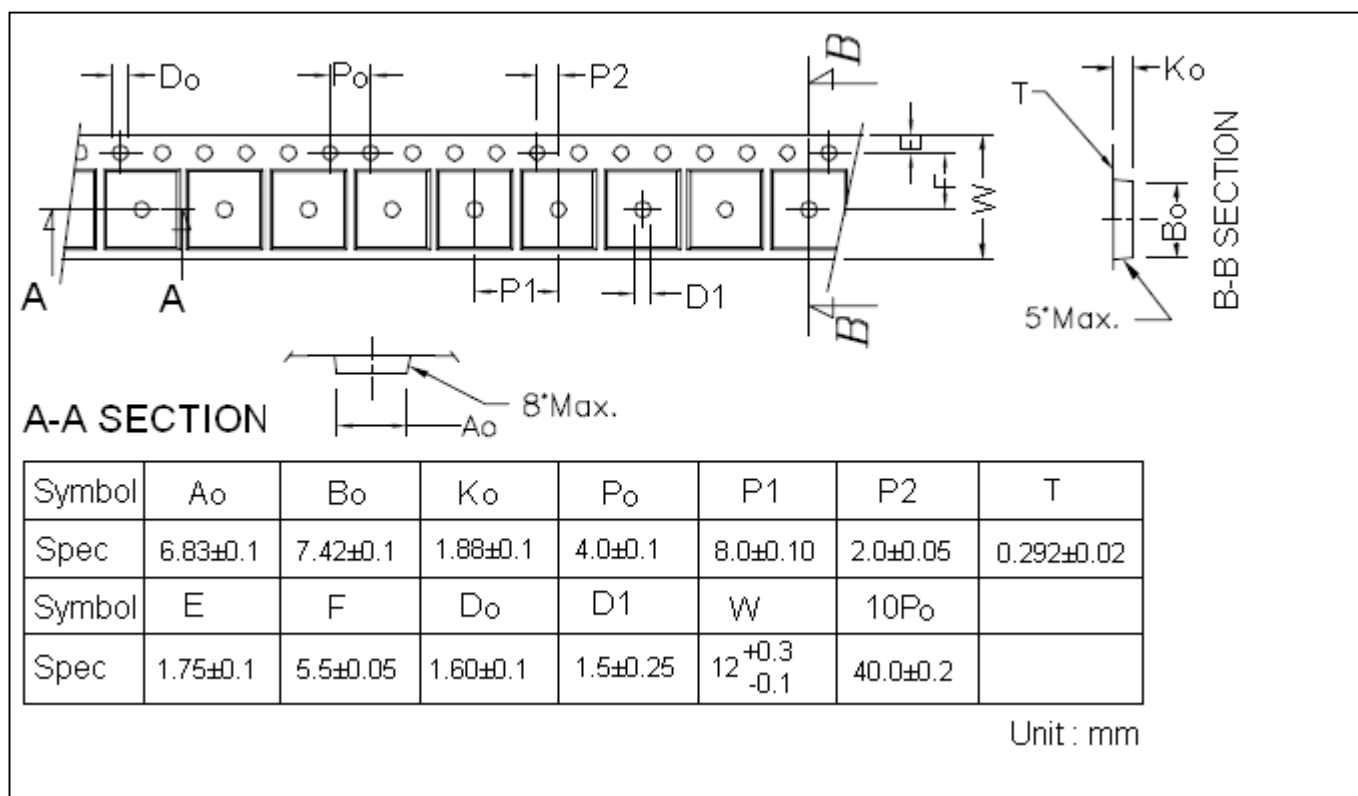

Recommended wave soldering condition

Product	Peak Temperature	Soldering Time
Pb-free devices	260 +0/-5 °C	5 +1/-1 seconds

Recommended temperature profile for IR reflow

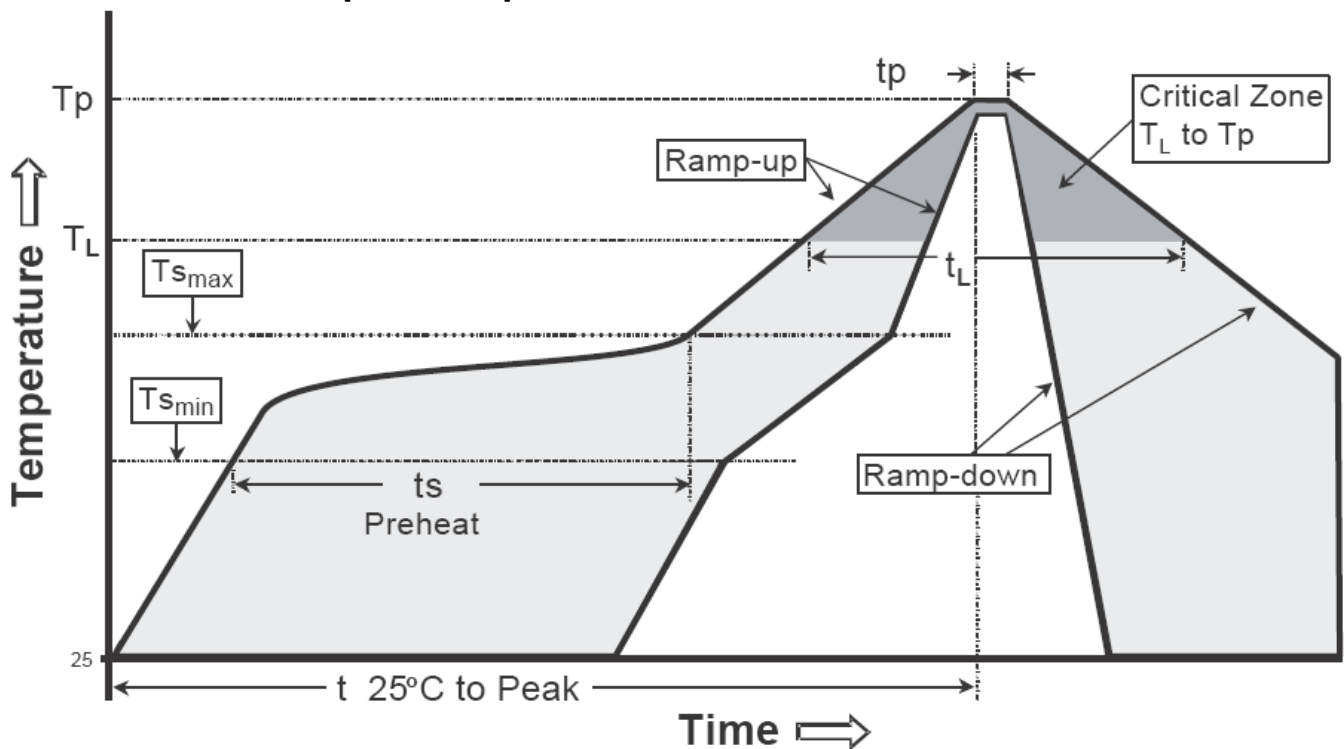

Profile feature	Sn-Pb eutectic Assembly	Pb-free Assembly
Average ramp-up rate (Tsmax to Tp)	3°C/second max.	3°C/second max.
Preheat		
-Temperature Min(Ts min)	100°C	150°C
-Temperature Max(Ts max)	150°C	200°C
-Time(ts min to ts max)	60-120 seconds	60-180 seconds
Time maintained above:		
-Temperature (TL)	183°C	217°C
- Time (tL)	60-150 seconds	60-150 seconds
Peak Temperature(TP)	240 +0/-5 °C	260 +0/-5 °C
Time within 5°C of actual peak temperature(tp)	10-30 seconds	20-40 seconds
Ramp down rate	6°C/second max.	6°C/second max.
Time 25 °C to peak temperature	6 minutes max.	8 minutes max.

Note : All temperatures refer to topside of the package, measured on the package body surface.

SOT-223 Dimension

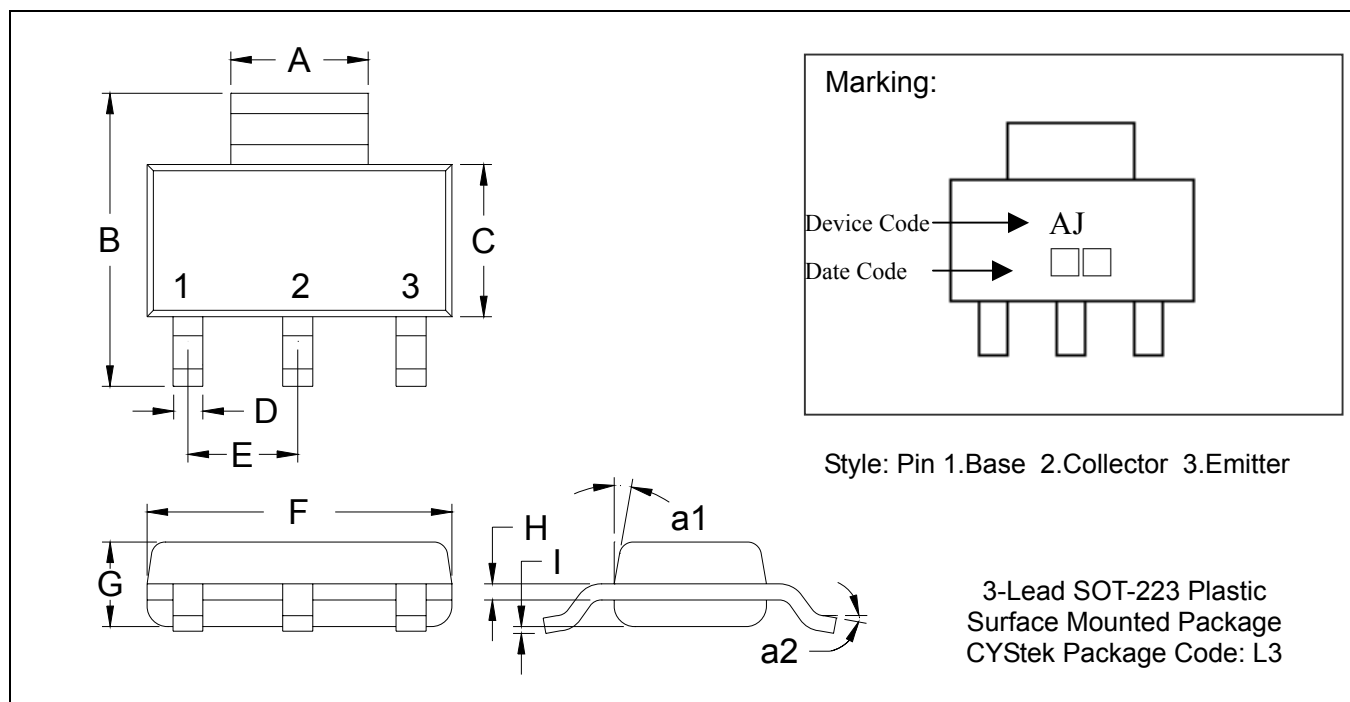

*: Typical

DIM	Inches		Millimeters		DIM	Inches		Millimeters	
	Min.	Max.	Min.	Max.		Min.	Max.	Min.	Max.
A	0.1142	0.1220	2.90	3.10	G	0.0551	0.0709	1.40	1.80
B	0.2638	0.2874	6.70	7.30	H	0.0098	0.0138	0.25	0.35
C	0.1299	0.1457	3.30	3.70	I	0.0008	0.0039	0.02	0.10
D	0.0236	0.0315	0.60	0.80	a1	*13°	-	*13°	-
E	*0.0906	-	*2.30	-	a2	0°	10°	0°	10°
F	0.2480	0.2638	6.30	6.70					

Notes: 1.Controlling dimension: millimeters.

2.Maximum lead thickness includes lead finish thickness, and minimum lead thickness is the minimum thickness of base material.

3.If there is any question with packing specification or packing method, please contact your local CYStek sales office.

Material:

- Lead: Pure tin plated.
- Mold Compound: Epoxy resin family, flammability solid burning class: UL94V-0

Important Notice:

- All rights are reserved. Reproduction in whole or in part is prohibited without the prior written approval of CYStek.
- CYStek reserves the right to make changes to its products without notice.
- CYStek **semiconductor products are not warranted to be suitable for use in Life-Support Applications, or systems.**
- CYStek assumes no liability for any consequence of customer product design, infringement of patents, or application assistance.