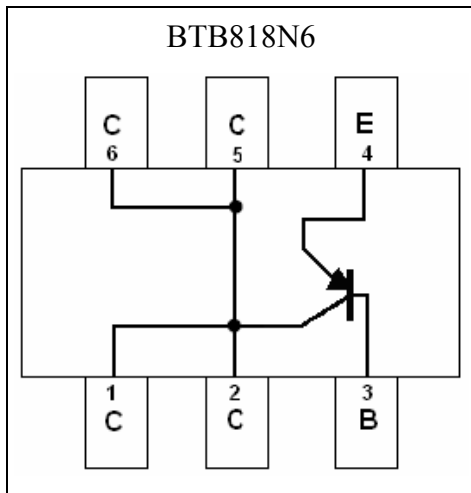
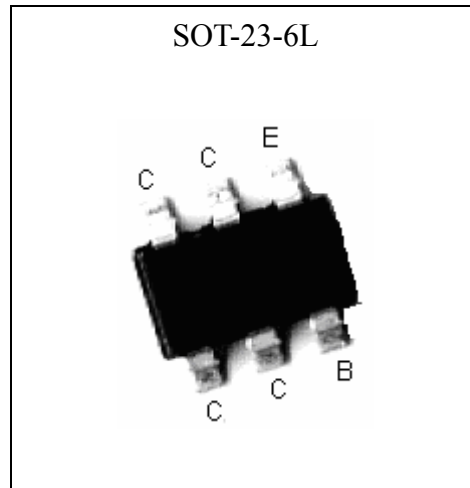

**Low Vcesat PNP Epitaxial Planar Transistor**

# BTB818N6

**Features**

- Low  $V_{CE(sat)}$ ,  $V_{CE(sat)} = -0.2V$  (typical), at  $I_C / I_B = -400mA / -20mA$
- Pb-free package

**Equivalent Circuit**

**Outline**

**Absolute Maximum Ratings** ( $T_a = 25^\circ C$ )

Parameter	Symbol	Limits	Unit
Collector-Base Voltage	$V_{CBO}$	-40	V
Collector-Emitter Voltage	$V_{CEO}$	-30	V
Emitter-Base Voltage	$V_{EBO}$	-7	V
Collector Current(DC)	$I_C$	-1.5	A
Peak Collector Current	$I_{CM}$	-3 *1	A
Peak Base Current	$I_{BM}$	-500	mA
Power Dissipation	$P_D$	1.2 *2	W
Thermal Resistance, Junction to Ambient	$R_{\theta JA}$	104	$^\circ C/W$
Operating Junction and Storage Temperature Range	$T_j; T_{stg}$	-55~+150	$^\circ C$

Note :1 Single pulse,  $P_w = 10ms$

2. When mounted on 25mm×25mm×1.6 mm FR-4 PCB with high coverage of single sided 1 oz copper, in still air condition.

**Characteristics (Ta=25°C)**

Symbol	Min.	Typ.	Max.	Unit	Test Conditions
BV <sub>CB0</sub>	-40	-	-	V	I <sub>C</sub> =-50μA, I <sub>E</sub> =0
BV <sub>CE0</sub>	-30	-	-	V	I <sub>C</sub> =-1mA, I <sub>B</sub> =0
BV <sub>EB0</sub>	-7	-	-	V	I <sub>E</sub> =-50μA, I <sub>C</sub> =0
I <sub>CB0</sub>	-	-	-100	nA	V <sub>CB</sub> =-40V, I <sub>E</sub> =0
I <sub>EB0</sub>	-	-	-100	nA	V <sub>EB</sub> =-7V, I <sub>C</sub> =0
*V <sub>CE(sat)</sub>	-	-0.2	-0.3	V	I <sub>C</sub> =-400mA, I <sub>B</sub> =-20mA
*V <sub>CE(sat)</sub>	-	-	-0.4	V	I <sub>C</sub> =-800mA, I <sub>B</sub> =-80mA
*V <sub>CE(sat)</sub>	-	-	-0.6	V	I <sub>C</sub> =-500mA, I <sub>B</sub> =-5mA
*V <sub>BE(sat)</sub>	-	-	-1.1	V	I <sub>C</sub> =-500mA, I <sub>B</sub> =-5mA
*V <sub>BE(on)</sub>	-	-	-1.1	V	V <sub>CE</sub> =-2V, I <sub>C</sub> =-500mA
*h <sub>FE 1</sub>	100	-	-	-	V <sub>CE</sub> =-1V, I <sub>C</sub> =-500mA
*h <sub>FE 2</sub>	100	-	-	-	V <sub>CE</sub> =-3V, I <sub>C</sub> =-1A
f <sub>T</sub>	-	150	-	MHz	V <sub>CE</sub> =-5V, I <sub>C</sub> =-10mA, f=100MHz
Cob	-	12	-	pF	V <sub>CB</sub> =-10V, f=1MHz

\*Pulse Test : Pulse Width ≤380μs, Duty Cycle≤2%

**Ordering Information**

Device	Package	Shipping	Marking
BTB818N6	SOT-23-6L (Pb-free)	3000 pcs / Tape & Reel	BK

**Typical Characteristics**

Emitter Grounded Output Characteristics

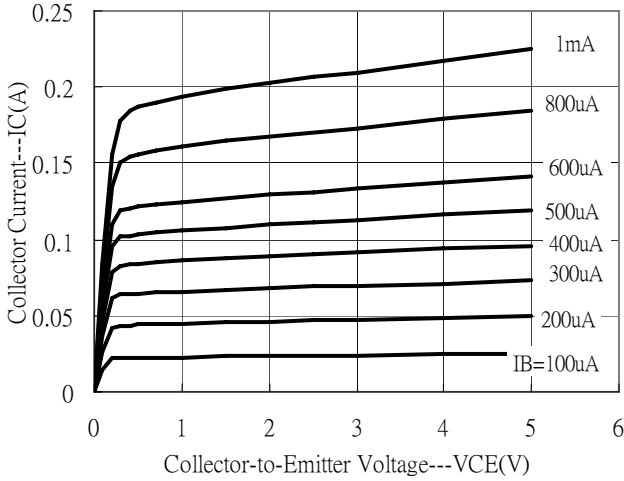

Emitter Grounded Output Characteristics

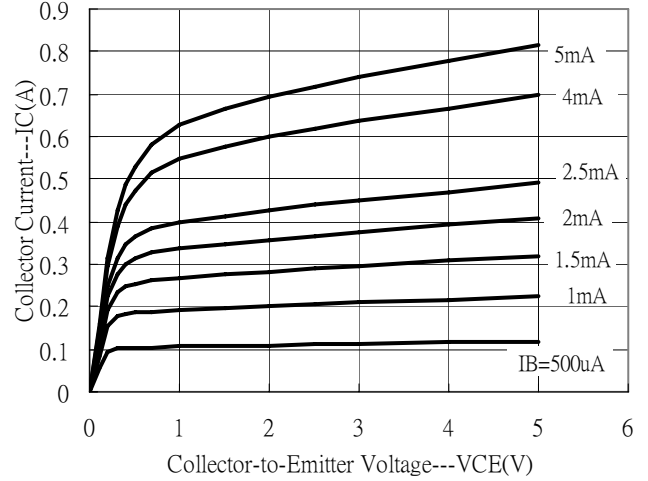

Emitter Grounded Output Characteristics

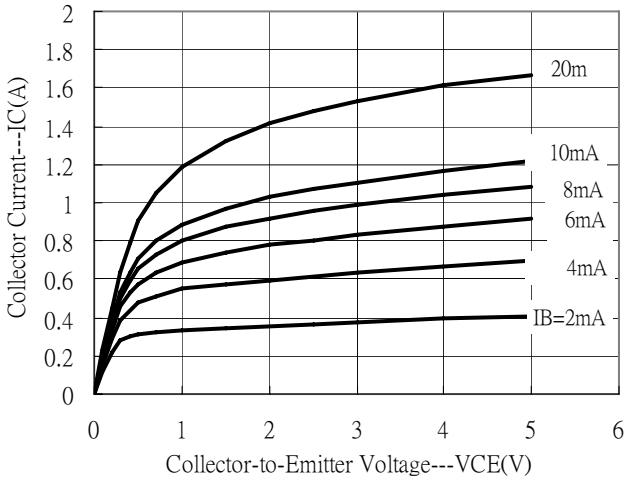

Emitter Grounded Output Characteristics

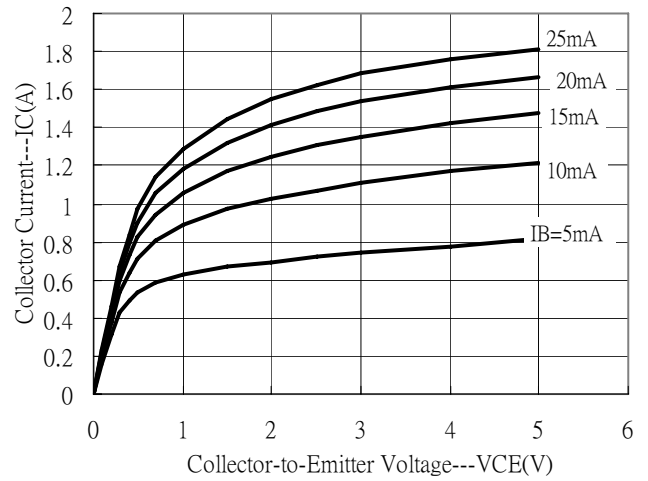

Current Gain vs Collector Current

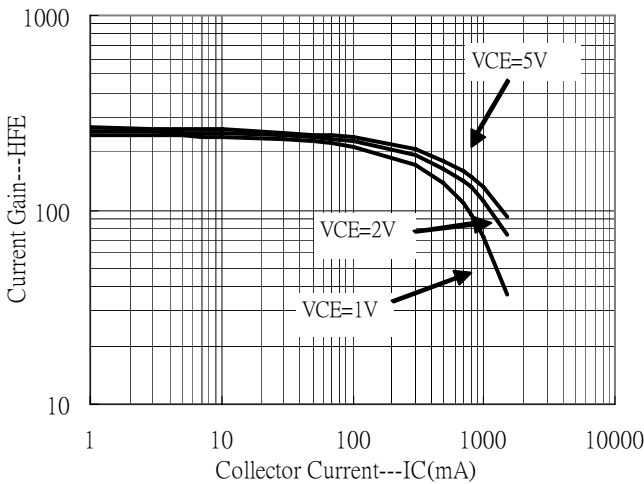

Saturation Voltage vs Collector Current

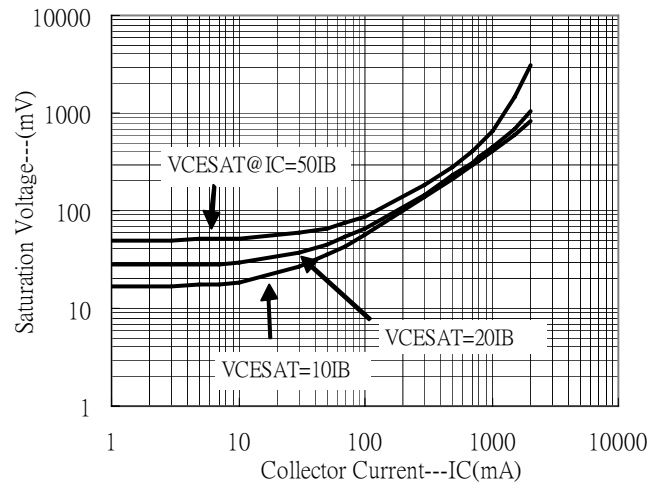

**Typical Characteristics(Cont.)**

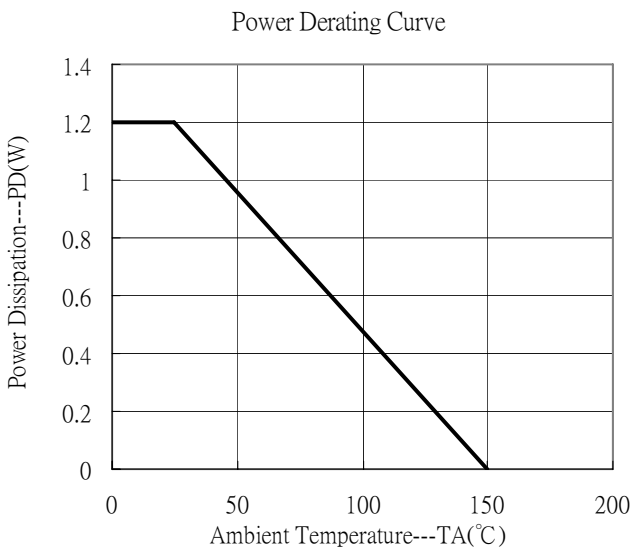
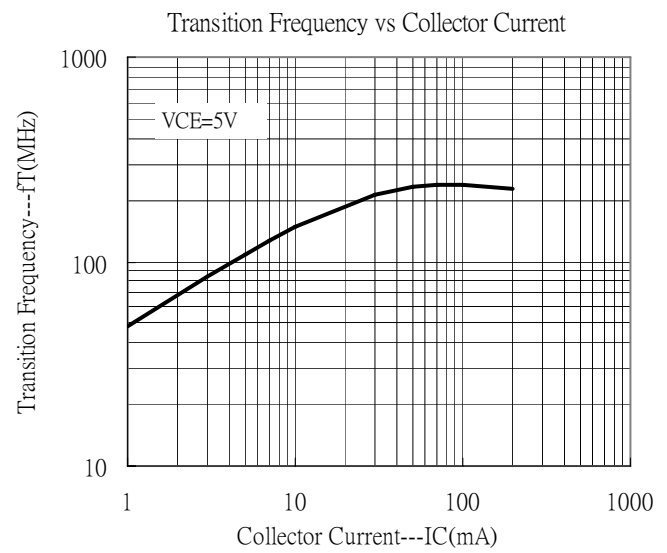
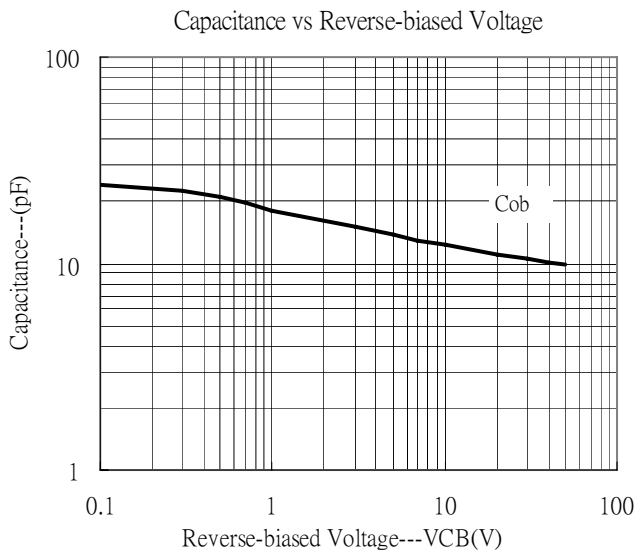
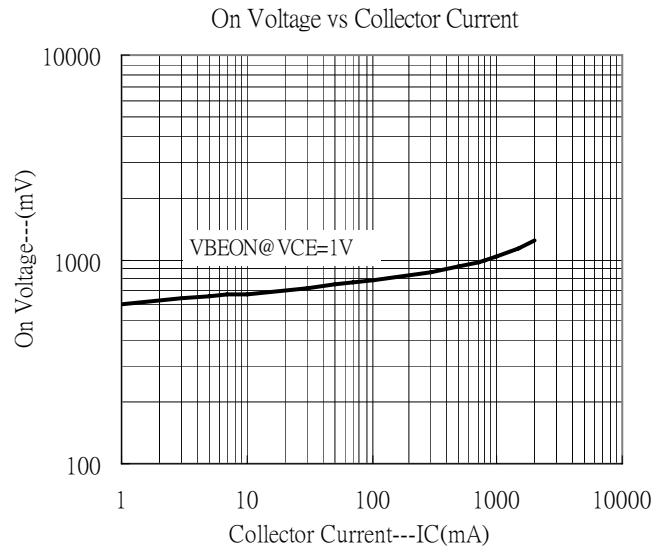
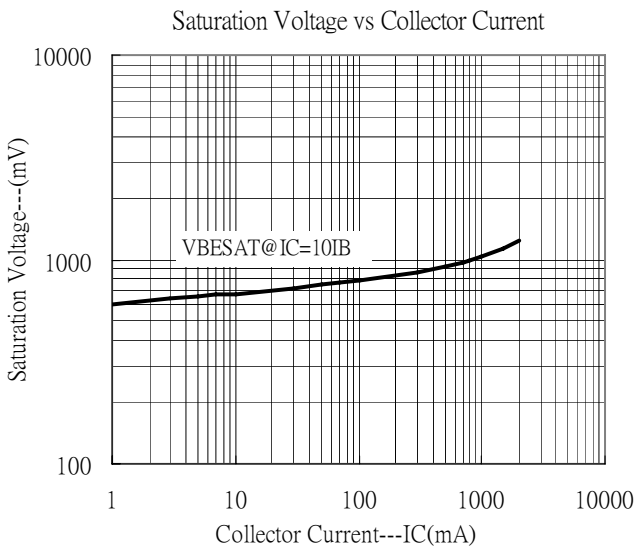



**Recommended wave soldering condition**

Product	Peak Temperature	Soldering Time
Pb-free devices	260 +0/-5 °C	5 +1/-1 seconds

**Recommended temperature profile for IR reflow**

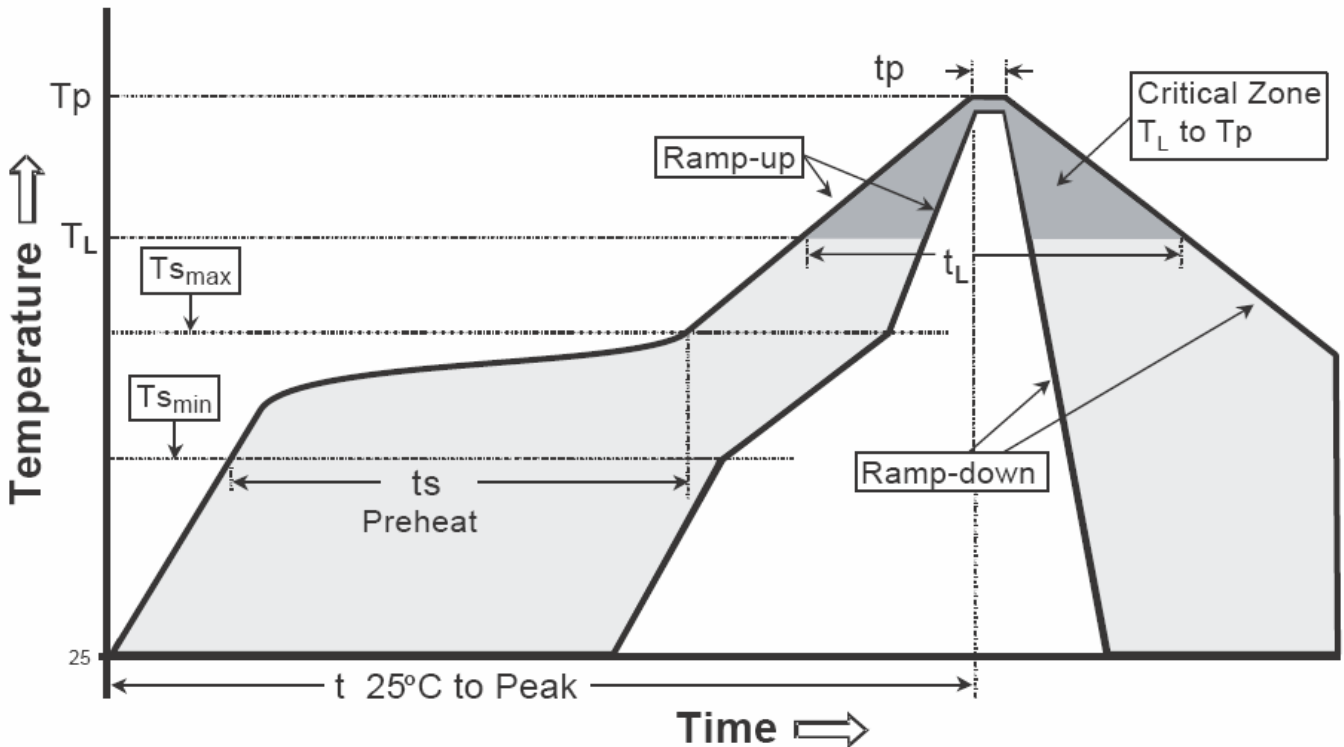

Profile feature	Sn-Pb eutectic Assembly	Pb-free Assembly
Average ramp-up rate (T <sub>smax</sub> to T <sub>p</sub> )	3°C/second max.	3°C/second max.
Preheat		
-Temperature Min(T <sub>s min</sub> )	100°C	150°C
-Temperature Max(T <sub>s max</sub> )	150°C	200°C
-Time(t <sub>s min</sub> to t <sub>s max</sub> )	60-120 seconds	60-180 seconds
Time maintained above:		
-Temperature (T <sub>L</sub> )	183°C	217°C
- Time (t <sub>L</sub> )	60-150 seconds	60-150 seconds
Peak Temperature(T <sub>P</sub> )	240 +0/-5 °C	260 +0/-5 °C
Time within 5°C of actual peak temperature(tp)	10-30 seconds	20-40 seconds
Ramp down rate	6°C/second max.	6°C/second max.
Time 25 °C to peak temperature	6 minutes max.	8 minutes max.

Note : All temperatures refer to topside of the package, measured on the package body surface.

**SOT-23-6L Dimension**

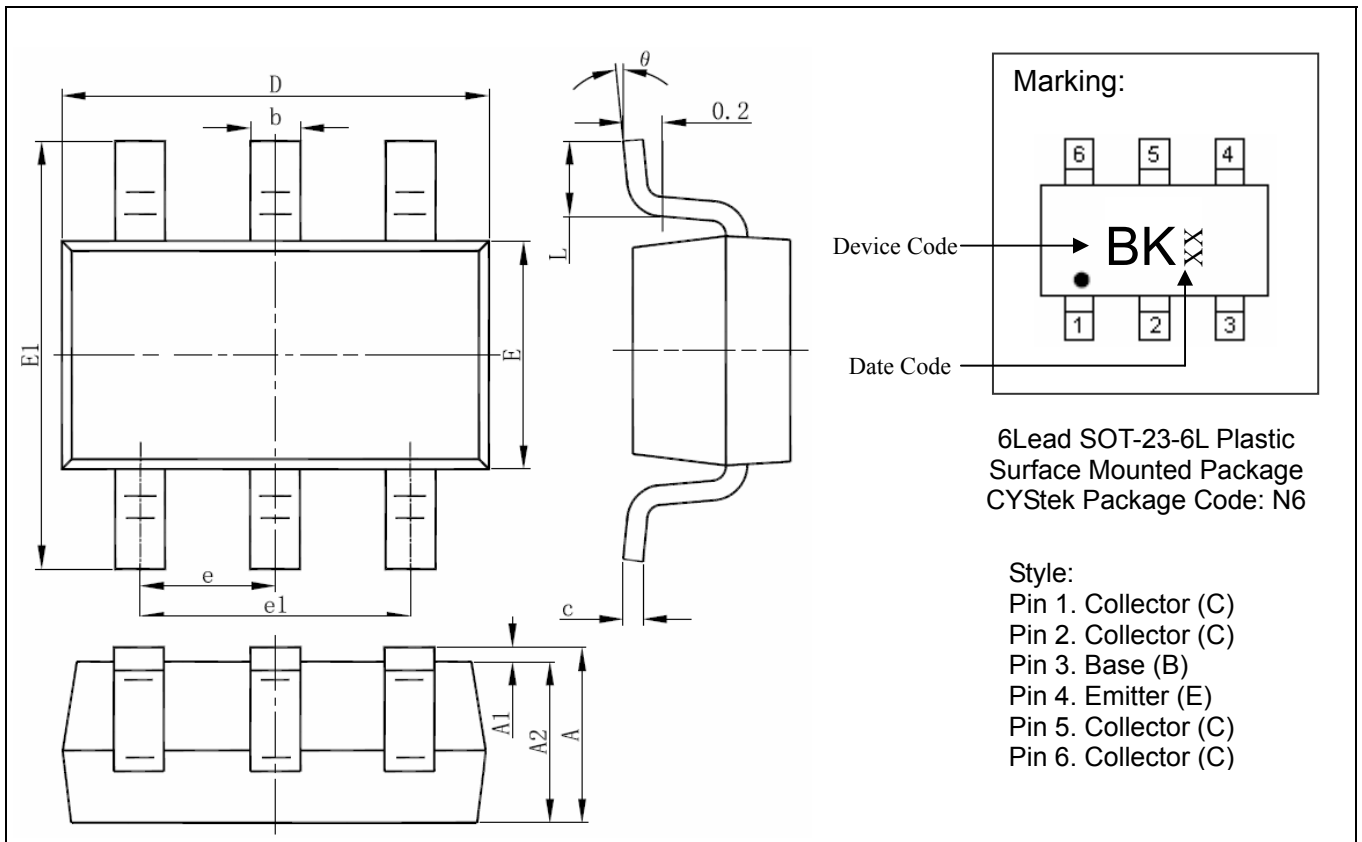

DIM	Millimeters		Inches		DIM	Millimeters		Inches	
	Min.	Max.	Min.	Max.		Min.	Max.	Min.	Max.
A	1.050	1.250	0.041	0.049	E	1.500	1.700	0.059	0.067
A1	0.000	0.100	0.000	0.004	E1	2.650	2.950	0.104	0.116
A2	1.050	1.150	0.041	0.045	e	0.950 (BSC)		0.037 (BSC)	
b	0.300	0.500	0.012	0.020	e1	1.800	2.000	0.071	0.079
c	0.100	0.200	0.004	0.008	L	0.300	0.600	0.012	0.024
D	2.820	3.020	0.111	0.119	θ	0°	8°	0°	8°

**Notes :** 1. Controlling dimension : millimeters.  
 2. Maximum lead thickness includes lead finish thickness, and minimum lead thickness is the minimum thickness of base material.  
 3. If there is any question with packing specification or packing method, please contact your local CYStek sales office.

**Material :**

- Lead : Pure tin plated.
- Mold Compound : Epoxy resin family, flammability solid burning class:UL94V-0.

**Important Notice:**

- All rights are reserved. Reproduction in whole or in part is prohibited without the prior written approval of CYStek.
- CYStek reserves the right to make changes to its products without notice.
- CYStek **semiconductor products are not warranted to be suitable for use in Life-Support Applications, or systems.**
- CYStek assumes no liability for any consequence of customer product design, infringement of patents, or application assistance.