

**General Purpose PNP Epitaxial Planar Transistors  
 (dual transistors)**

# HBA1873S5

**Features**

- Two BTA1037 chips in a SOT-353 package.
- Mounting possible with SOT-323 automatic mounting machines.
- Mounting cost and area can be cut in half.
- Complementary to HBC4944S5.
- Pb-free lead plating package.

**Equivalent Circuit**

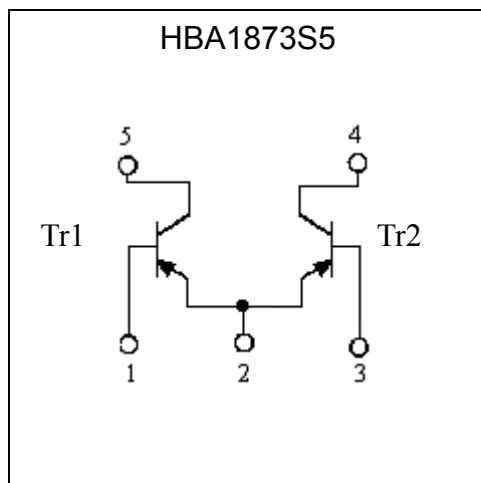

**Outline**

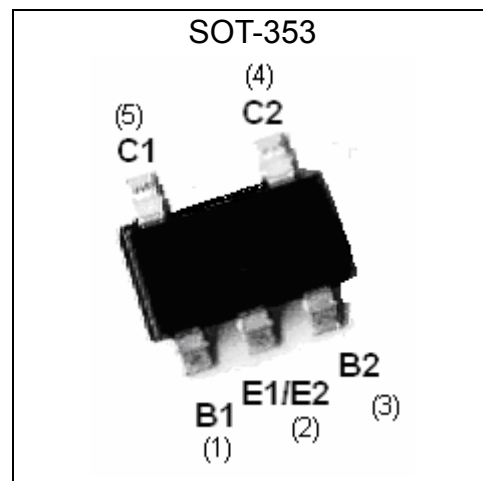

**The following characteristics apply to both Tr1 and Tr2**

**Absolute Maximum Ratings** (Ta=25°C)

Parameter	Symbol	Limits	Unit
Collector-Base Voltage	V <sub>CBO</sub>	-60	V
Collector-Emitter Voltage	V <sub>CEO</sub>	-50	V
Emitter-Base Voltage	V <sub>EBO</sub>	-6	V
Collector Current	I <sub>C</sub>	-150	mA
Base Current	I <sub>B</sub>	-30	mA
Power Dissipation	P <sub>D</sub>	200(total) *1	mW
Junction Temperature	T <sub>j</sub>	150	°C
Storage Temperature	T <sub>stg</sub>	-55~+150	°C

Note : \*1 150mW per element must not be exceeded.

**Characteristics (Ta=25°C)**

Symbol	Min.	Typ.	Max.	Unit	Test Conditions
BVCBO	-60	-	-	V	IC=-50μA
BVCEO	-50	-	-	V	IC=-1mA
BVEBO	-6	-	-	V	IE=-50μA
ICBO	-	-	-0.1	μA	VCB=-60V
IEBO	-	-	-0.1	μA	VEB=-6V
*VCE(sat)	-	-0.2	-0.3	V	IC=-100mA, IB=-10mA
*hFE	200	-	400		VCE=-6V, IC=-1mA
fT	80	110	-	MHz	VCE=-12V, IC=-1mA, f=100MHz
Cob	-	2.3	3.5	pF	VCB=-10V, f=1MHz

\*Pulse Test: Pulse Width ≤380μs, Duty Cycle≤2%

**Ordering Information**

Device	Package	Shipping	Marking
HBA1873S5	SOT-353 (Pb-free lead plating package)	3000 pcs / Tape & Reel	SGR

## Typical Characteristics

Emitter Grounded Output Characteristics

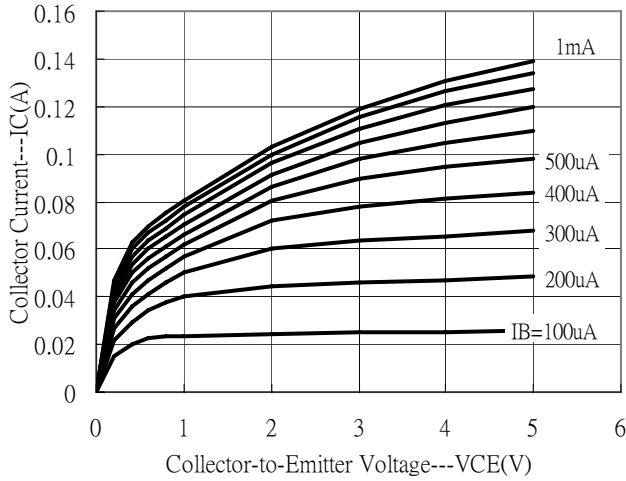

Emitter Grounded Output Characteristics

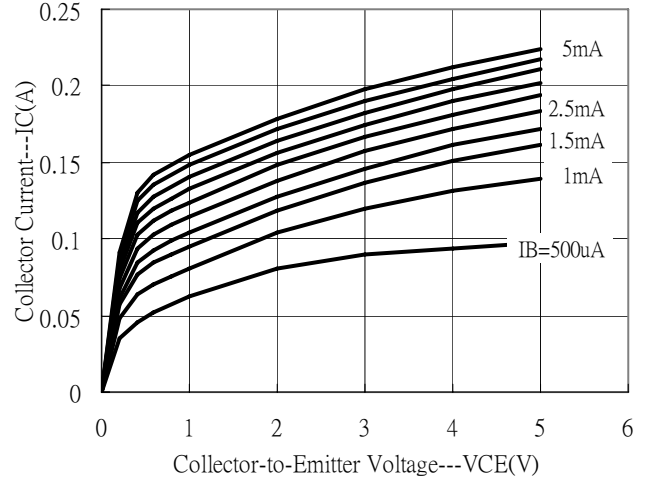

Current Gain vs Collector Current

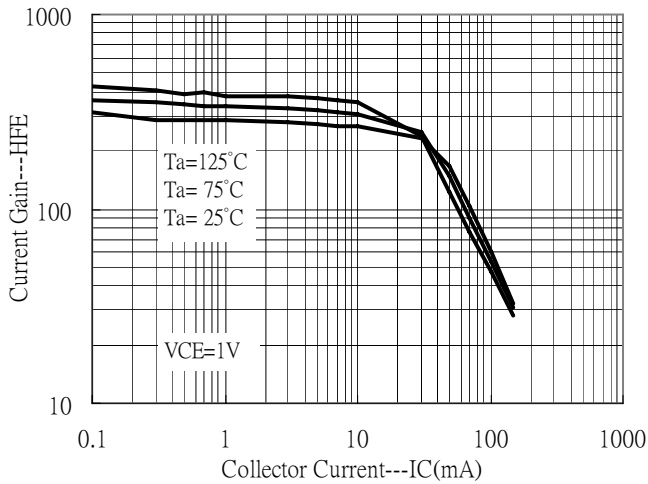

Current Gain vs Collector Current

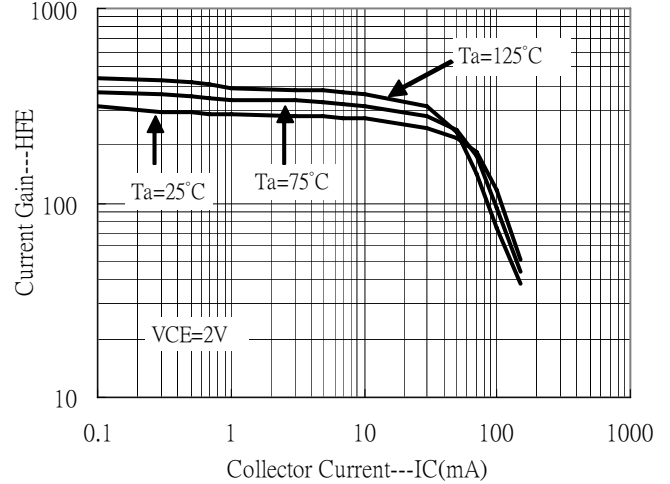

Current Gain vs Collector Current

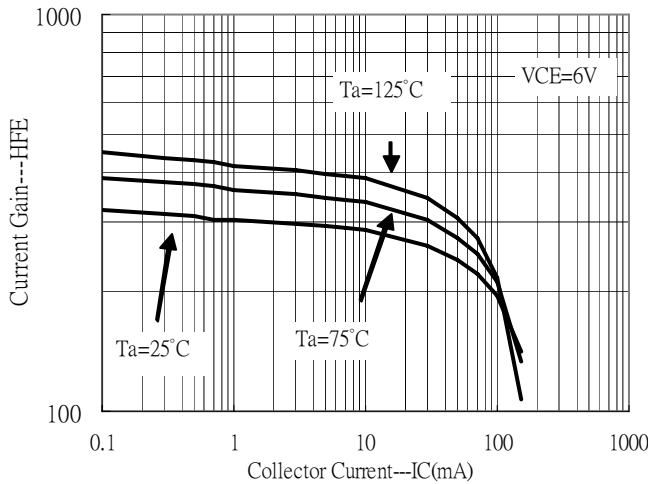

Saturation Voltage vs Collector Current

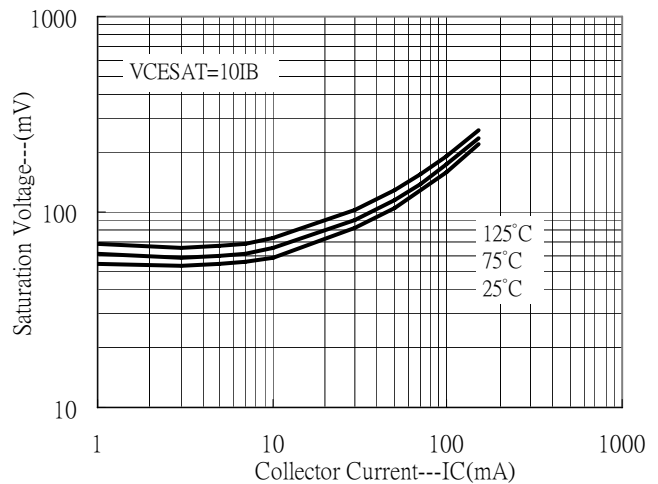

**Typical Characteristics(Cont.)**

Saturation Voltage vs Collector Current

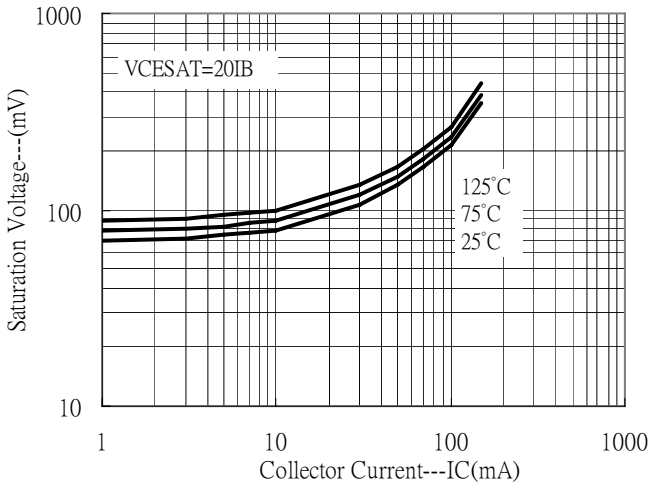

Saturation Voltage vs Collector Current

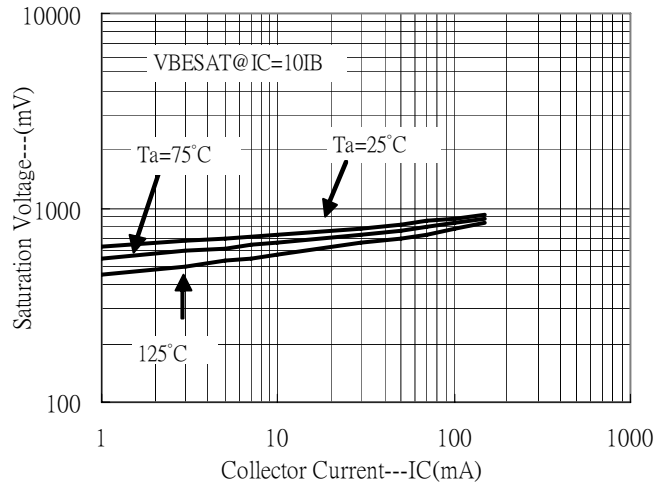

On Voltage vs Collector Current

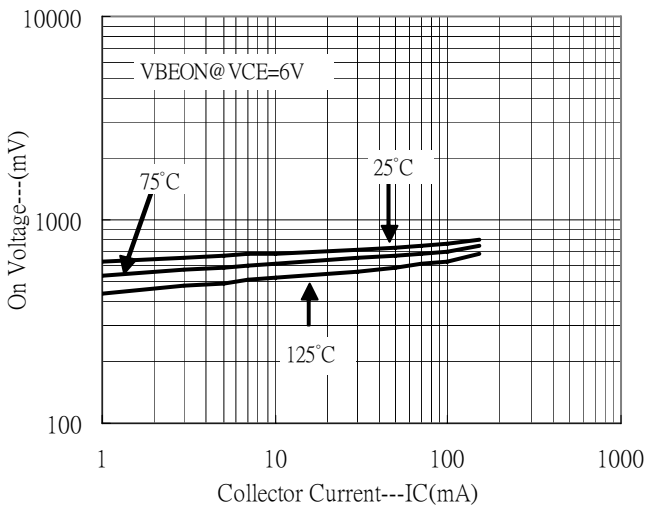

Cutoff Frequency vs Collector Current

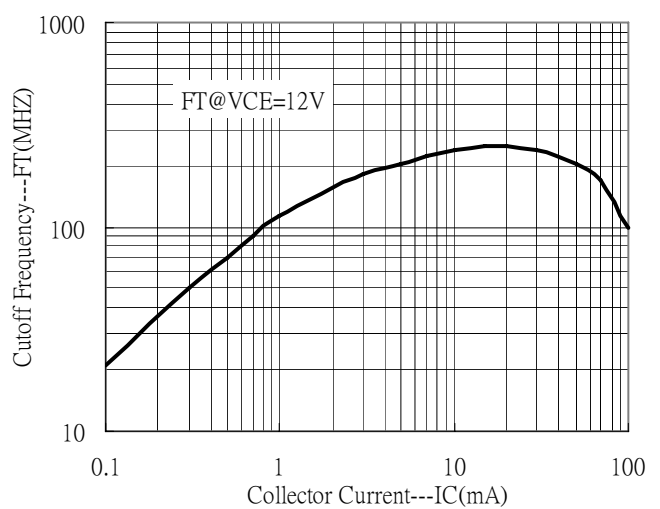

Capacitance vs Reverse-biased Voltage

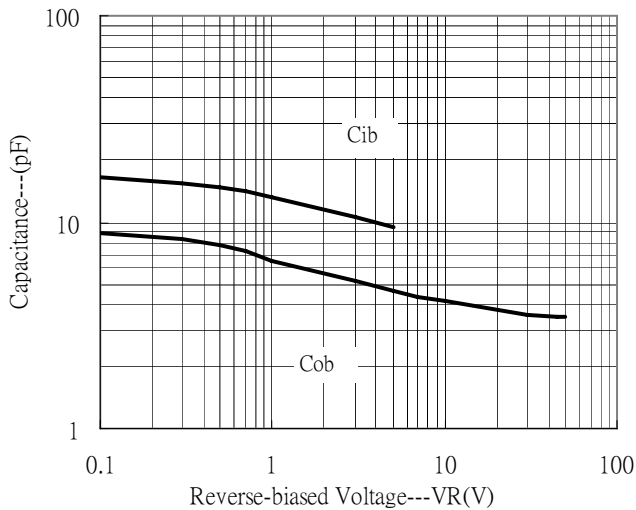

Power Derating Curves

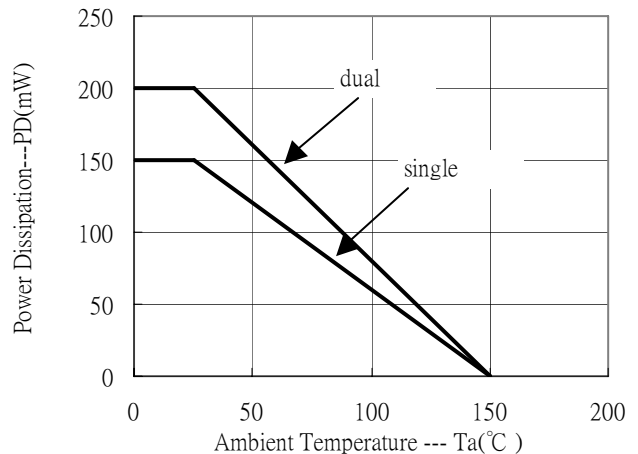

### Reel Dimension

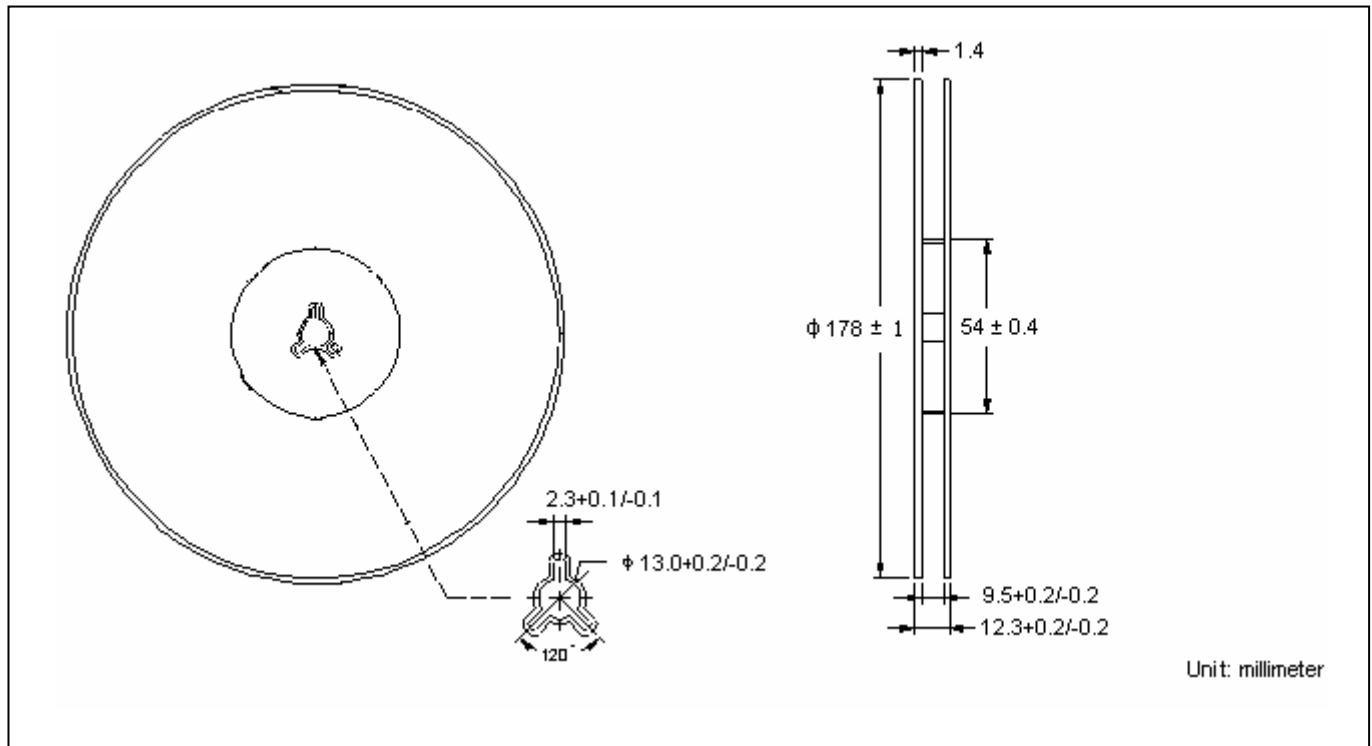

### Carrier Tape Dimension

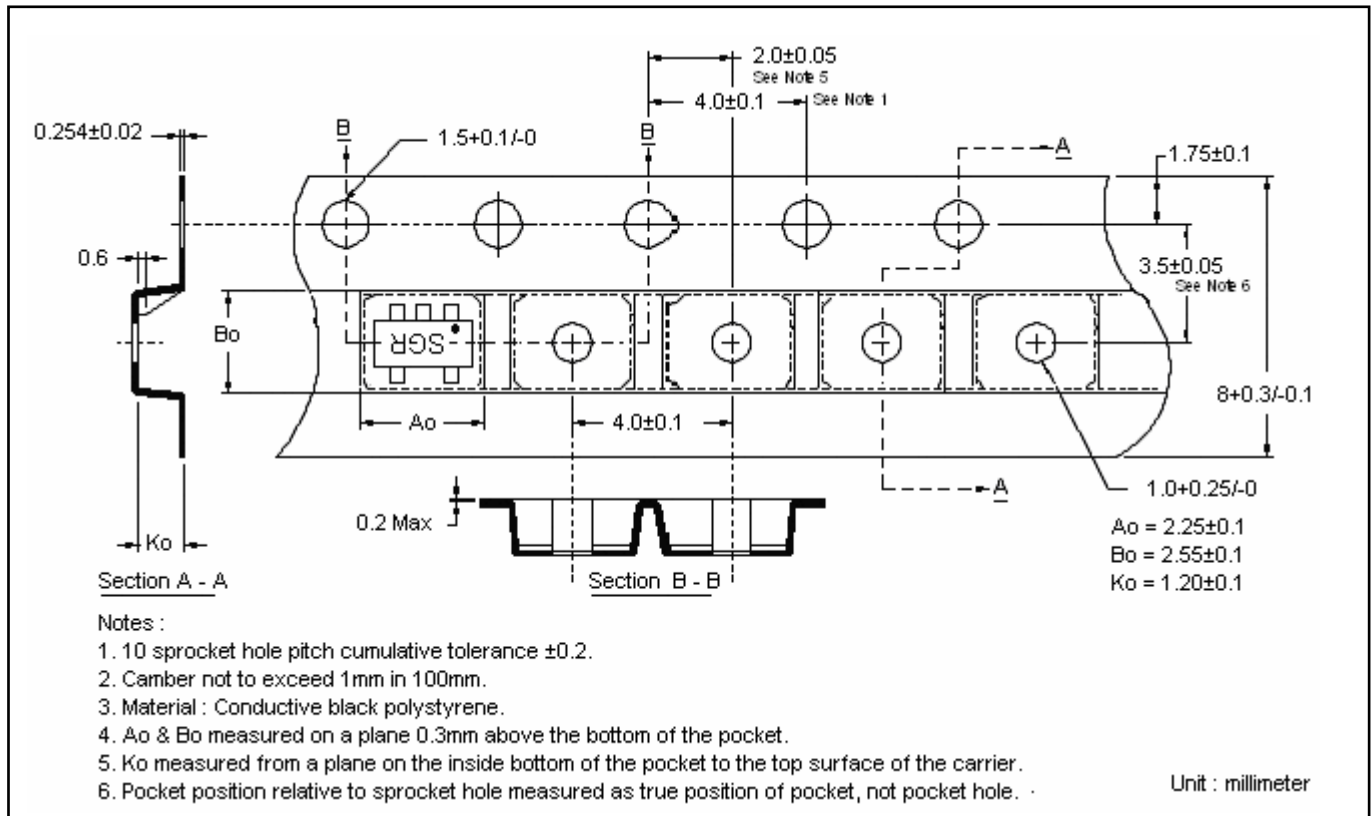

**Recommended wave soldering condition**

Product	Peak Temperature	Soldering Time
Pb-free devices	260 +0/-5 °C	5 +1/-1 seconds

**Recommended temperature profile for IR reflow**

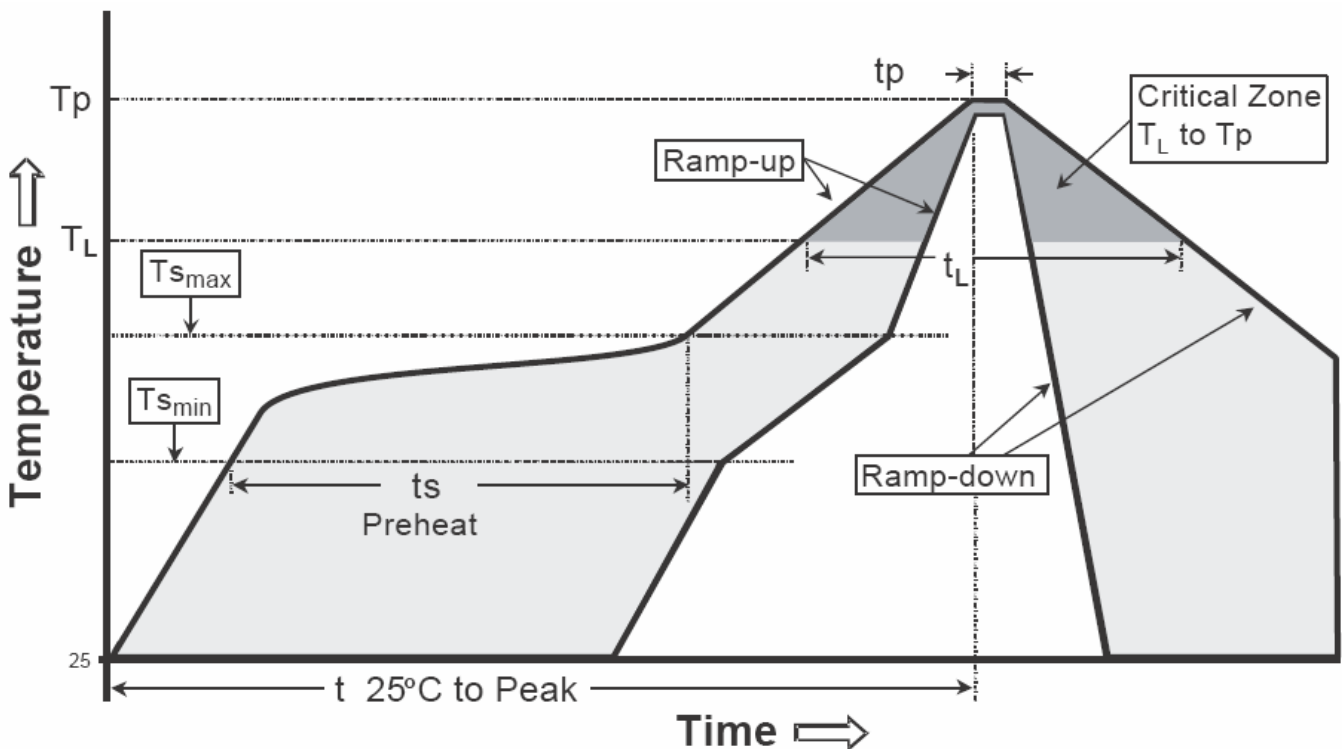

Profile feature	Sn-Pb eutectic Assembly	Pb-free Assembly
Average ramp-up rate (T <sub>smax</sub> to T <sub>p</sub> )	3°C/second max.	3°C/second max.
Preheat		
-Temperature Min(T <sub>s min</sub> )	100°C	150°C
-Temperature Max(T <sub>s max</sub> )	150°C	200°C
-Time(t <sub>s min</sub> to t <sub>s max</sub> )	60-120 seconds	60-180 seconds
Time maintained above:		
-Temperature (T <sub>L</sub> )	183°C	217°C
- Time (t <sub>L</sub> )	60-150 seconds	60-150 seconds
Peak Temperature(T <sub>P</sub> )	240 +0/-5 °C	260 +0/-5 °C
Time within 5°C of actual peak temperature(tp)	10-30 seconds	20-40 seconds
Ramp down rate	6°C/second max.	6°C/second max.
Time 25 °C to peak temperature	6 minutes max.	8 minutes max.

Note : All temperatures refer to topside of the package, measured on the package body surface.

**SOT-353 Dimension**

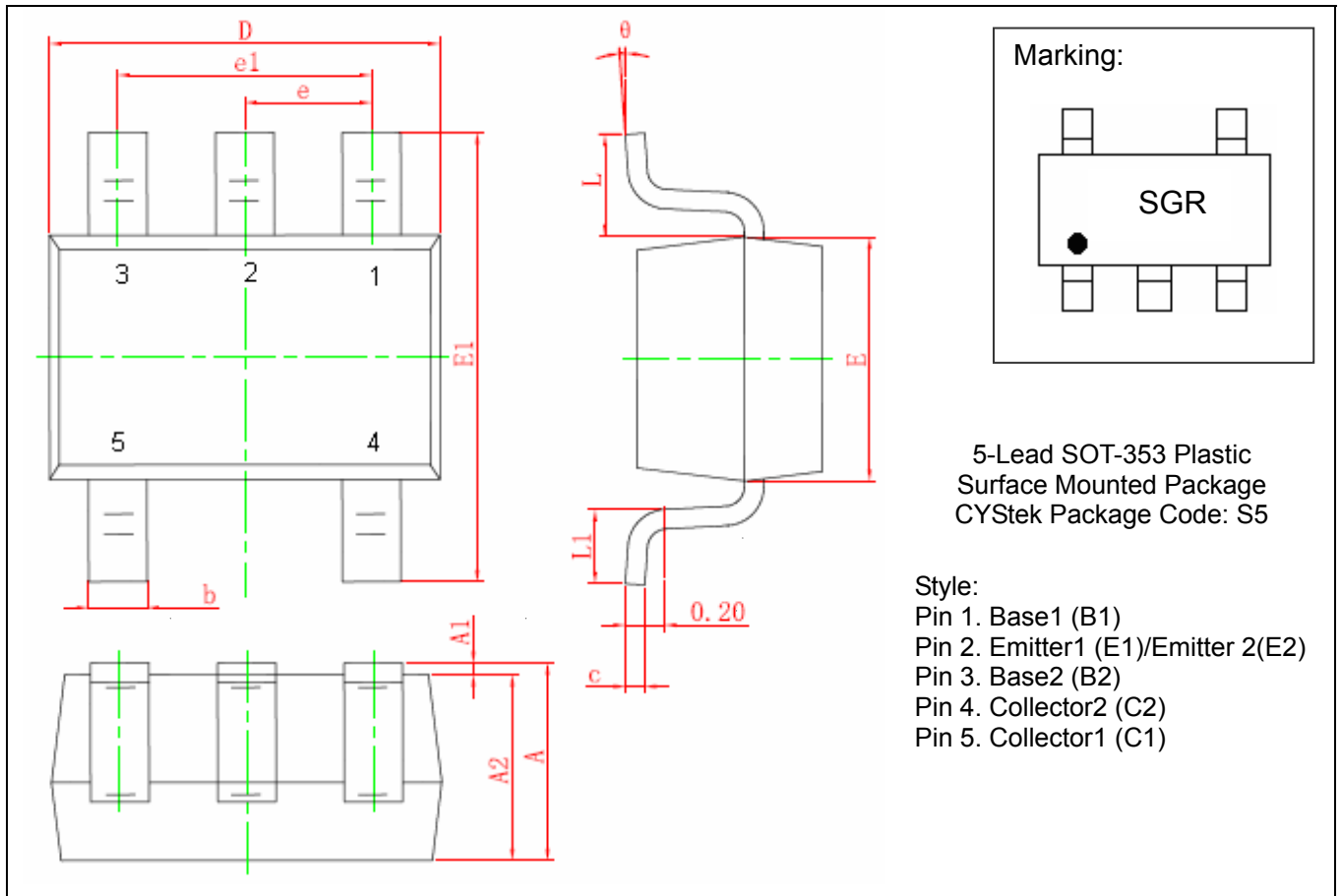

\*:Typical

DIM	Millimeters		Inches		DIM	Millimeters		Inches	
	Min.	Max.	Min.	Max.		Min.	Max.	Min.	Max.
A	0.900	1.100	0.035	0.043	E1	2.150	2.450	0.085	0.096
A1	0.000	0.100	0.000	0.004	e	0.650*		0.026*	
A2	0.900	1.000	0.035	0.039	e1	1.200	1.400	0.047	0.055
b	0.150	0.350	0.006	0.014	L	0.525	REF	0.021	REF
c	0.080	0.150	0.003	0.006	L1	0.260	0.460	0.010	0.018
D	2.000	2.200	0.079	0.087	θ	0°	8°	0°	8°
E	1.150	1.350	0.045	0.053					

Notes : 1.Controlling dimension : millimeters.  
 2.Maximum lead thickness includes lead finish thickness, and minimum lead thickness is the minimum thickness of base material.  
 3.If there is any question with packing specification or packing method, please contact your local CYStek sales office.

**Material :**

- Lead : Pure tin plated.
- Mold Compound : Epoxy resin family, flammability solid burning class:UL94V-0.

**Important Notice:**

- All rights are reserved. Reproduction in whole or in part is prohibited without the prior written approval of CYStek.
- CYStek reserves the right to make changes to its products without notice.
- CYStek **semiconductor products are not warranted to be suitable for use in Life-Support Applications, or systems.**
- CYStek assumes no liability for any consequence of customer product design, infringement of patents, or application assistance.