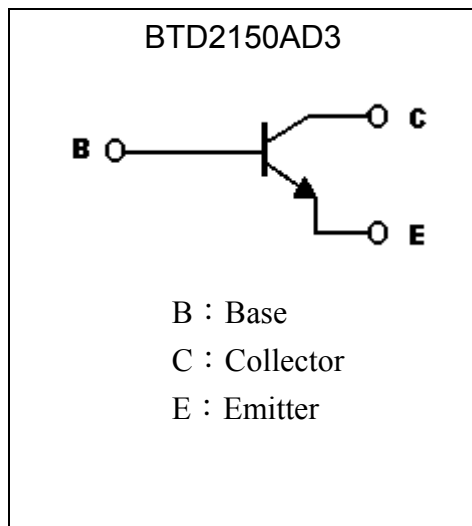
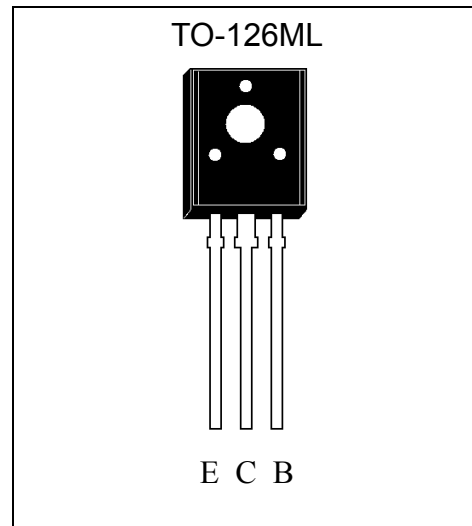

Low Vcesat NPN Epitaxial Planar Transistor

BTD2150AD3

Features

- Low $V_{CE(sat)}$, $V_{CE(sat)}=0.25$ V (typical), at $I_C / I_B = 2A / 200mA$
- Excellent current gain characteristics
- Complementary to BTB1424AD3
- Pb-free package

Symbol

Outline

Absolute Maximum Ratings ($T_a=25^\circ\text{C}$)

Parameter	Symbol	Limits	Unit
Collector-Base Voltage	V_{CBO}	50	V
Collector-Emitter Voltage	V_{CEO}	50	V
Emitter-Base Voltage	V_{EBO}	5	V
Collector Current (DC)	I_C	3	A
Collector Current (Pulse)	I_{CP}	7 (Note)	
Power Dissipation ($T_A=25^\circ\text{C}$)	P_D	1	W
Power Dissipation ($T_C=25^\circ\text{C}$)		10	
Junction Temperature	T_j	150	$^\circ\text{C}$
Storage Temperature	T_{stg}	-55~+150	$^\circ\text{C}$

Note : Pulse test, pulse width $\leq 380\mu\text{s}$, duty cycle $\leq 2\%$.

Characteristics (Ta=25°C)

Symbol	Min.	Typ.	Max.	Unit	Test Conditions
BV _{CB0}	50	-	-	V	I _C =50μA, I _E =0
BV _{CE0}	50	-	-	V	I _C =1mA, I _B =0
BV _{EB0}	5	-	-	V	I _E =50μA, I _C =0
I _{CB0}	-	-	1	μA	V _{CB} =40V, I _E =0
I _{EB0}	-	-	1	μA	V _{EB} =3V, I _C =0
*V _{CE(sat)}	-	0.25	0.5	V	I _C =2A, I _B =200mA
*V _{BE(sat)}	-	-	2	V	I _C =2A, I _B =200mA
*h _{FE1}	100	-	-	-	V _{CE} =2V, I _C =20mA
*h _{FE2}	180	-	820	-	V _{CE} =2V, I _C =100mA
*h _{FE3}	100	-	-	-	V _{CE} =2V, I _C =1A
f _T	-	90	-	MHz	V _{CE} =5V, I _C =100mA, f=100MHz
Cob	-	45	-	pF	V _{CB} =10V, f=1MHz

*Pulse Test : Pulse Width ≤380μs, Duty Cycle ≤2%

Classification Of hFE 2

Rank	R	S	T
Range	180~390	270~560	390~820

Characteristic Curves

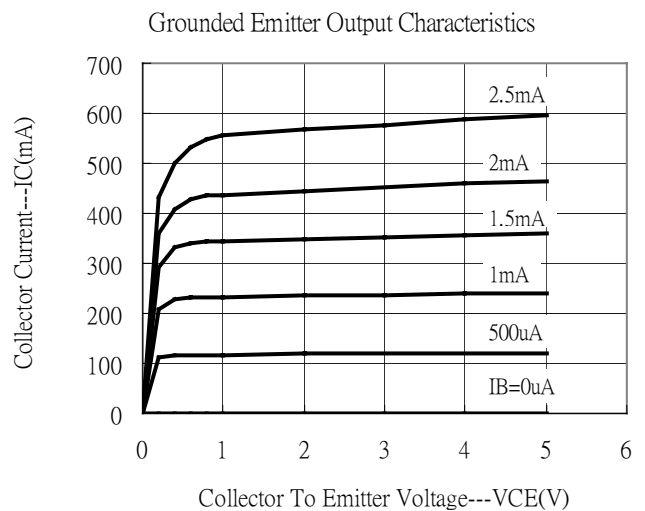
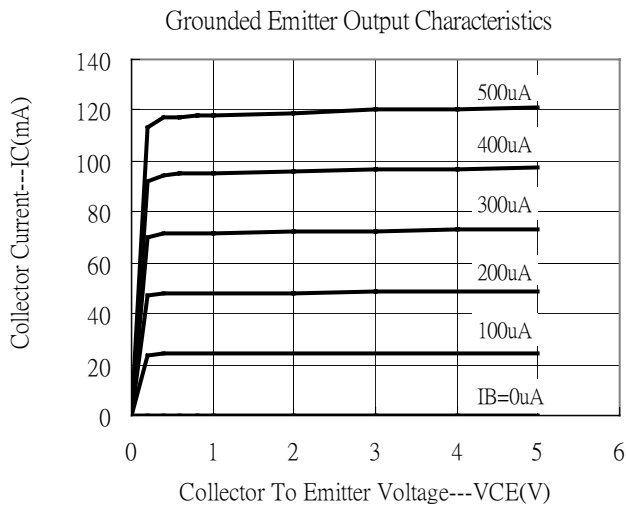



Grounded Emitter Output Characteristics

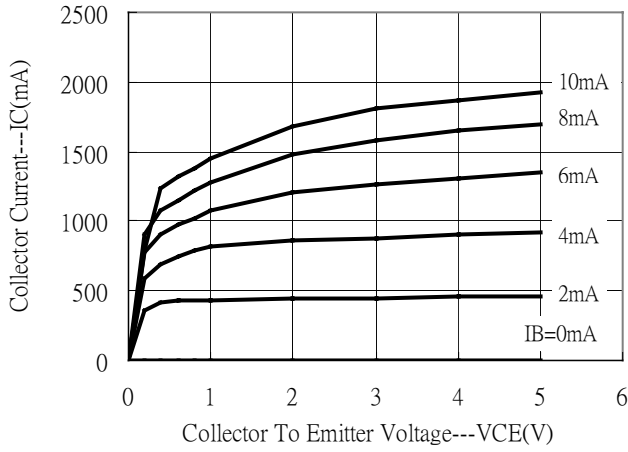

Grounded Emitter Output Characteristics

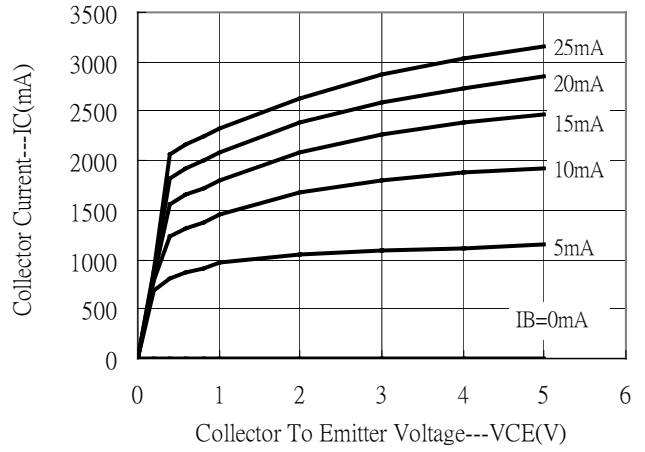

Current gain vs Collector current

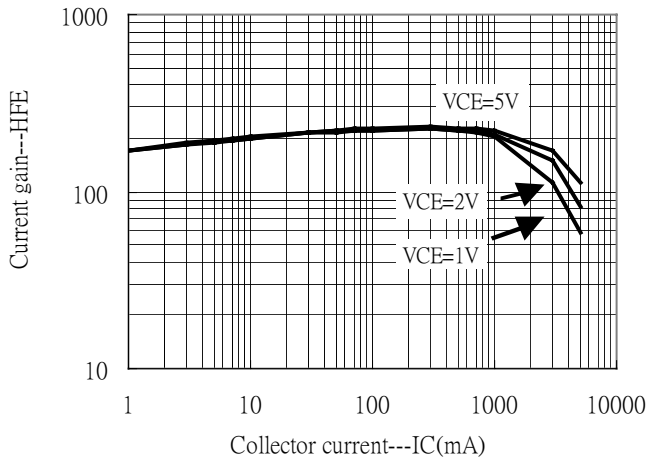

Saturation voltage vs Collector current

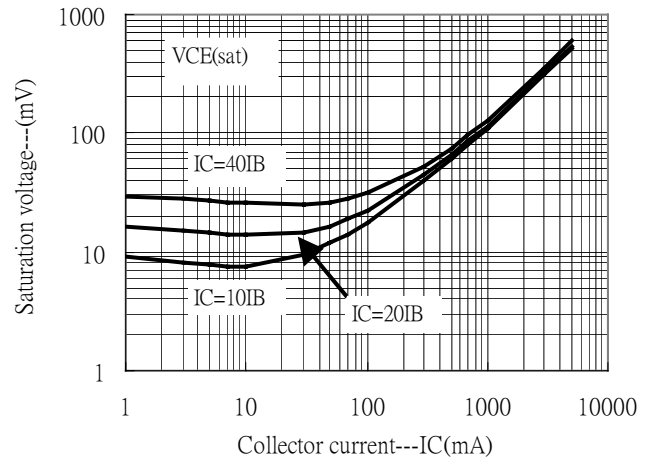

Saturation voltage vs Collector current

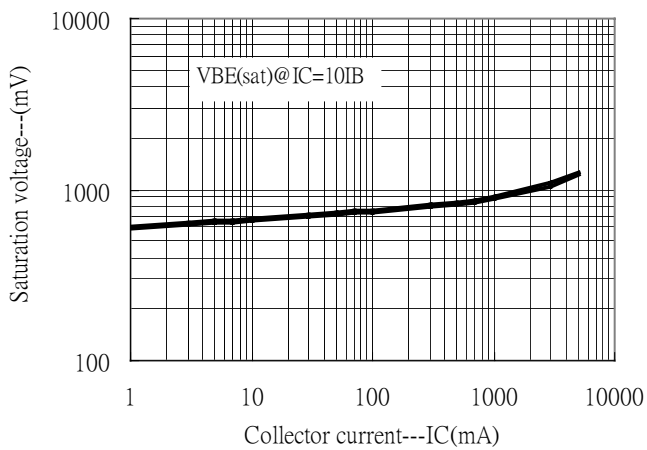

Power Derating Curve

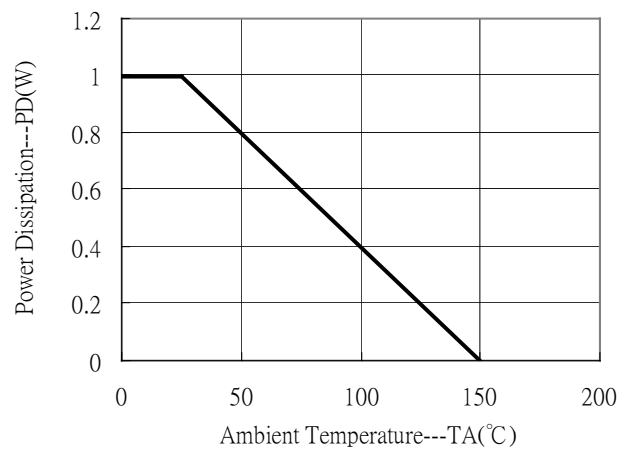

TO-126ML Dimension

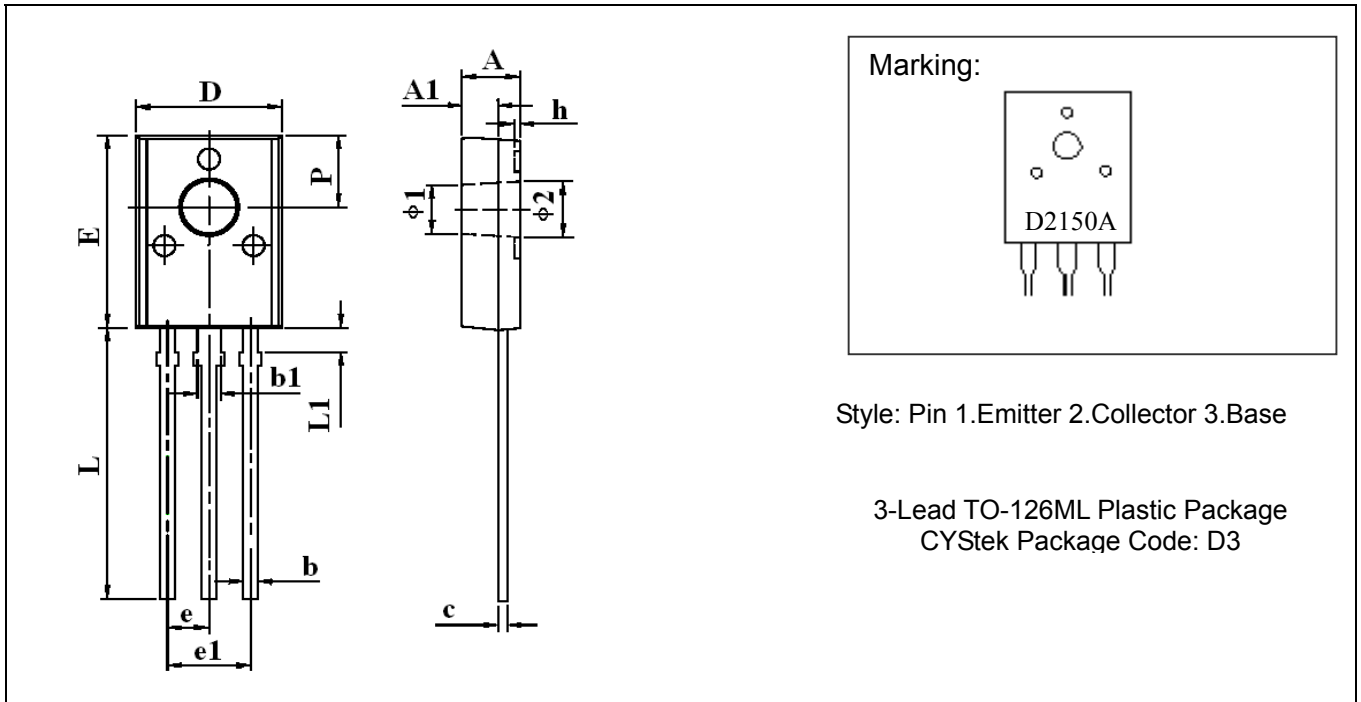

*: Typical

DIM	Inches		Millimeters		DIM	Inches		Millimeters	
	Min.	Max.	Min.	Max.		Min.	Max.	Min.	Max.
A	0.118	0.134	3.000	3.400	e	*0.090		*2.28	
A1	0.071	0.087	1.800	2.200	e1	0.176	0.183	4.460	4.660
b	0.026	0.034	0.660	0.860	L	0.594	0.610	15.100	15.500
b1	0.046	0.054	1.170	1.370	L1	0.051	0.059	1.300	1.500
c	0.018	0.024	0.450	0.600	P	0.159	0.167	4.040	4.240
D	0.307	0.323	7.800	8.200	Φ ₁	0.118	0.126	3.000	3.200
E	0.425	0.441	10.800	11.200	Φ ₂	0.122	0.130	3.100	3.300

Notes: 1. Controlling dimension: millimeters.
 2. Maximum lead thickness includes lead finish thickness, and minimum lead thickness is the minimum thickness of base material.
 3. If there is any question with packing specification or packing method, please contact your local CYStek sales office.

Material:

- Lead: 42 Alloy ; solder plating
- Mold Compound: Epoxy resin family, flammability solid burning class: UL94V-0

Important Notice:

- All rights are reserved. Reproduction in whole or in part is prohibited without the prior written approval of CYStek.
- CYStek reserves the right to make changes to its products without notice.
- CYStek **semiconductor products are not warranted to be suitable for use in Life-Support Applications, or systems.**
- CYStek assumes no liability for any consequence of customer product design, infringement of patents, or application assistance.