

Low Vcesat NPN Epitaxial Planar Transistor

BTD1805AD3

Description

The device is manufactured in NPN planar technology by using a “Base Island” layout. The resulting transistor shows exceptional high gain performance coupled with very low saturation voltage.

Features

- Very low collector-to-emitter saturation voltage
- Fast switching speed
- High current gain characteristic
- Large current capability
- Pb-free lead plating package

Applications

- CCFL drivers
- Voltage regulators
- Relay drivers
- High efficiency low voltage switching applications

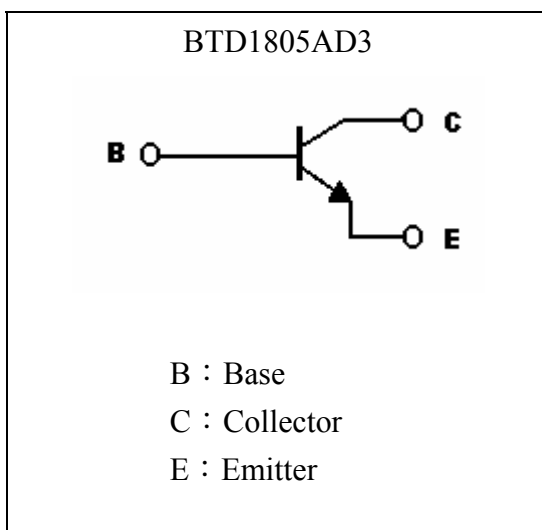
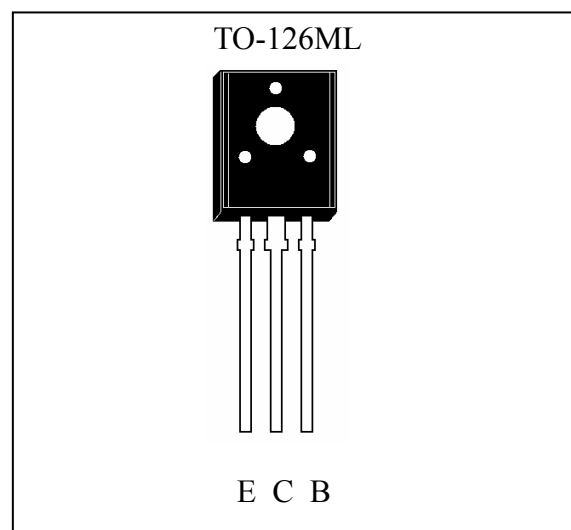
Symbol**Outline**



Absolute Maximum Ratings (Ta=25°C)

Parameter	Symbol	Limits	Unit
Collector-Base Voltage (IE=0)	V _{CBO}	120	V
Collector-Emitter Voltage (IB=0)	V _{CEO}	60	V
Emitter-Base Voltage (IC=0)	V _{EBO}	8	V
Collector Current (DC)	I _C	5	A
Collector Current (Pulse)	I _{CP}	10 (Note 1)	
Base Current	I _B	2	A
Power Dissipation @ TA=25°C	P _D	1.5	W
Power Dissipation @ TC=25°C	P _D	20	
Thermal Resistance, Junction to Ambient	R _{θJA}	83.3	°C/W
Thermal Resistance, Junction to Case	R _{θJC}	6.25	°C/W
Junction Temperature	T _j	150	°C
Storage Temperature	T _{stg}	-55~+150	°C

Note : 1. Single Pulse , Pw ≤ 380μs, Duty ≤ 2%.

Characteristics (Ta=25°C)

Symbol	Min.	Typ.	Max.	Unit	Test Conditions
BV _{CBO}	120	-	-	V	I _C =100μA, I _E =0
*BV _{CEO}	60	-	-	V	I _C =1mA, I _B =0
BV _{EBO}	8	-	-	V	I _C =100μA, I _C =0
I _{CBO}	-	-	0.1	μA	V _{CB} =120V, I _E =0
I _{EBO}	-	-	0.1	μA	V _{EB} =8V, I _C =0
*V _{CE(sat)} 1	-	-	50	mV	I _C =100mA, I _B =5mA
*V _{CE(sat)} 2	-	190	250	mV	I _C =2A, I _B =50mA
*V _{CE(sat)} 3	-	230	300	mV	I _C =3A, I _B =150mA
*V _{CE(sat)} 4	-	-	400	mV	I _C =5A, I _B =200mA
*V _{CE(sat)} 5	-	-	300	mV	I _C =2A, I _B =20mA
*V _{CE(sat)} 6	-	-	500	mV	I _C =2A, I _B =10mA
*V _{BE(sat)}	-	0.9	1	V	I _C =2A, I _B =100mA
*h _{FE} 1	200	-	450	-	V _{CE} =2V, I _C =100mA
*h _{FE} 2	120	-	-	-	V _{CE} =2V, I _C =5A
*h _{FE} 3	40	-	-	-	V _{CE} =2V, I _C =10A
f _T	-	150	-	MHz	V _{CE} =10V, I _C =50mA
C _{ob}	-	50	-	pF	V _{CB} =10V, f=1MHz
t _{on}	-	50	-	ns	V _{CC} =30V, I _C =10I _B I _B =-10I _B I _B =1A, R _L =30Ω
t _{stg}	-	1.35	2.5	μs	
t _f	-	120	1000	ns	

*Pulse Test : Pulse Width ≤ 380μs, Duty Cycle ≤ 2%

Typical Characteristics

Emitter Grounded Output Characteristics

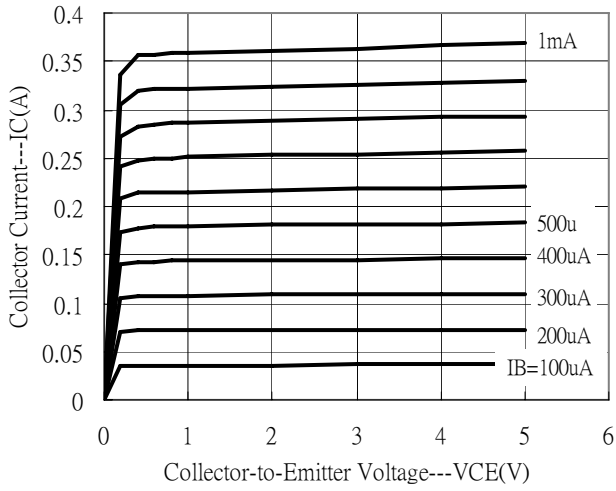

Emitter Grounded Output Characteristics

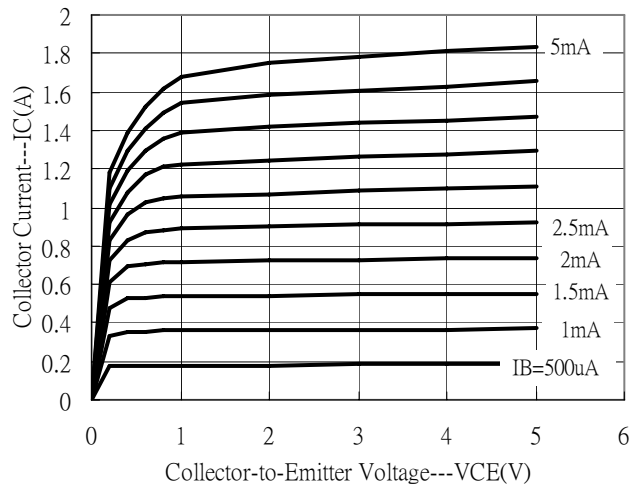

Emitter Grounded Output Characteristics

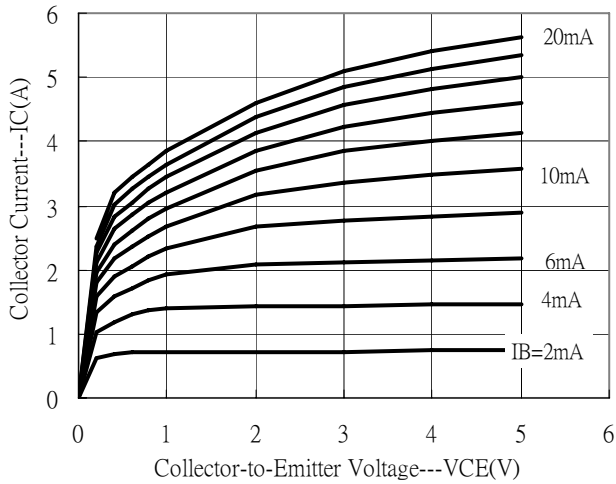

Emitter Grounded Output Characteristics

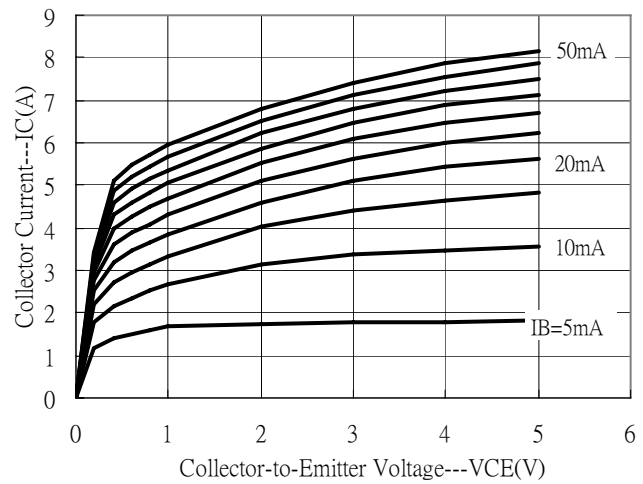

Current Gain vs Collector Current

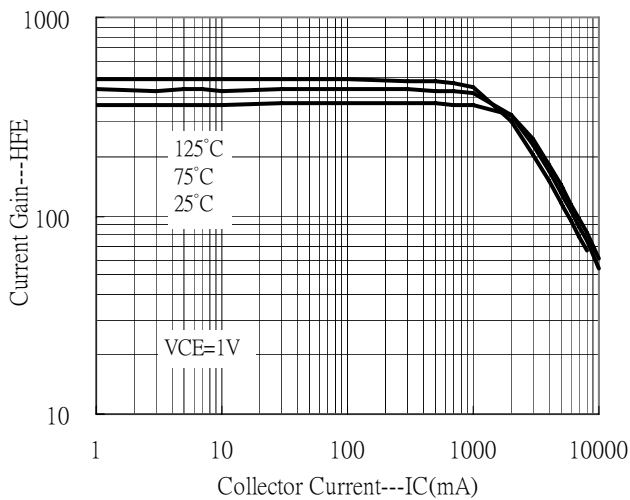

Current Gain vs Collector Current

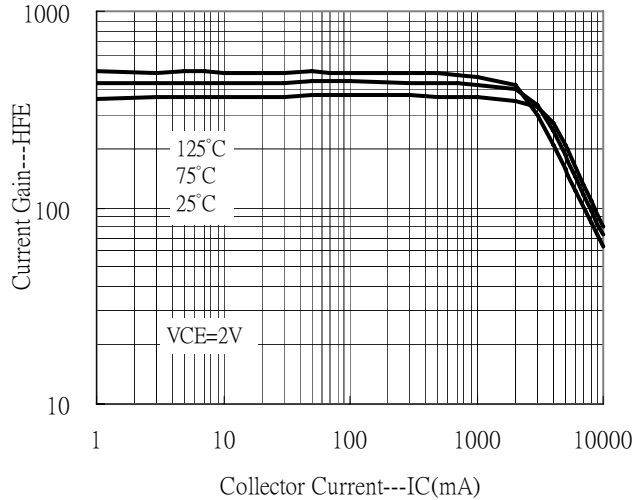

Typical Characteristics(Cont.)

Current Gain vs Collector Current

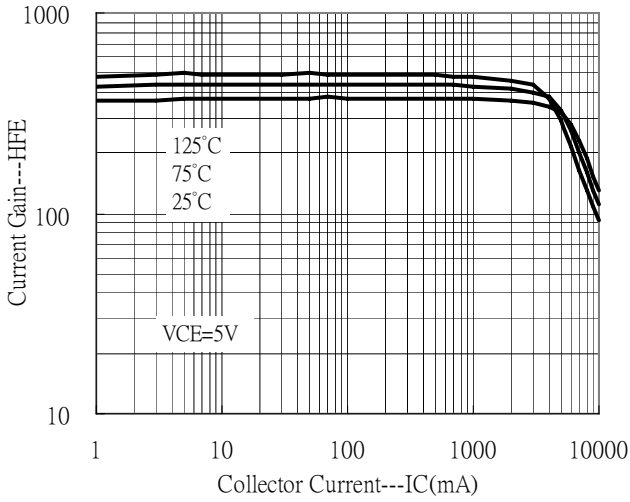

Saturation Voltage vs Collector Current

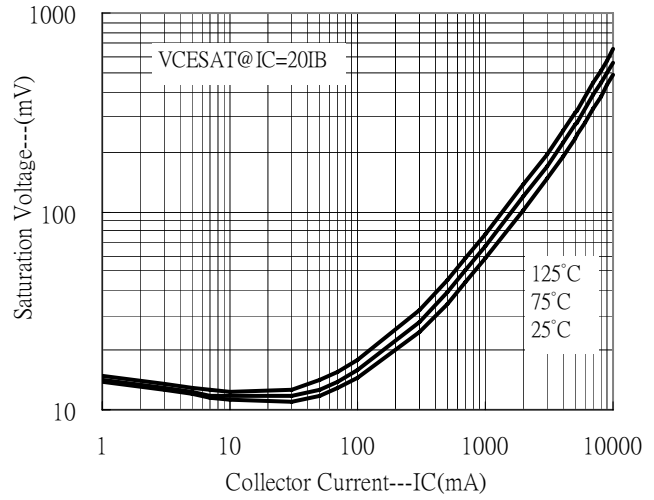

Saturation Voltage vs Collector Current

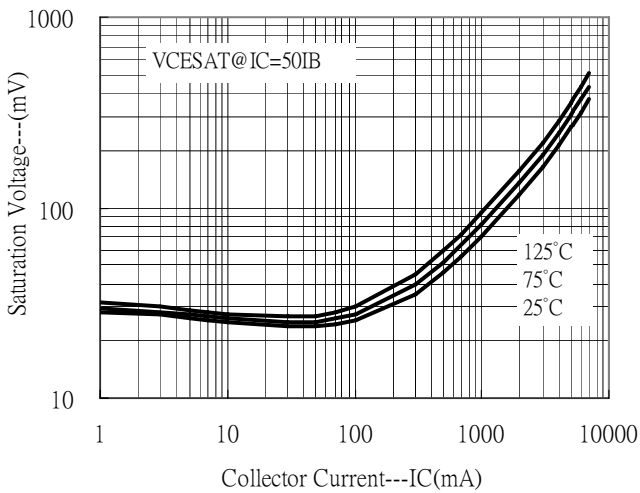

Saturation Voltage vs Collector Current

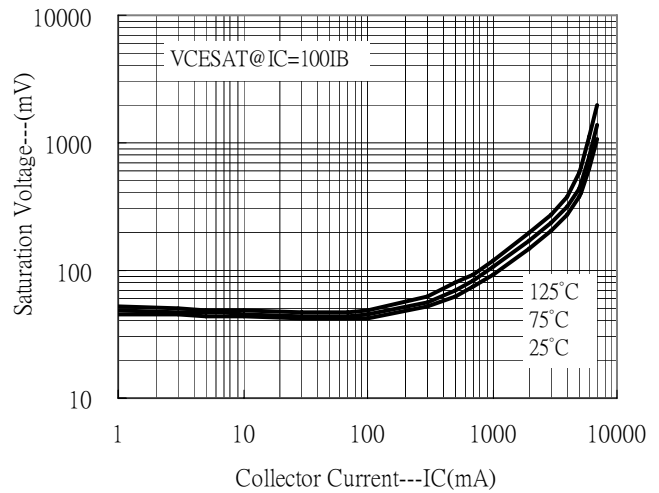

Saturation Voltage vs Collector Current

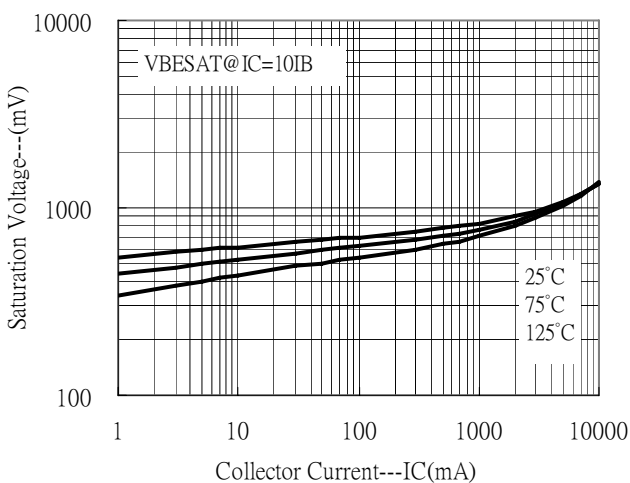

On Voltage vs Collector Current

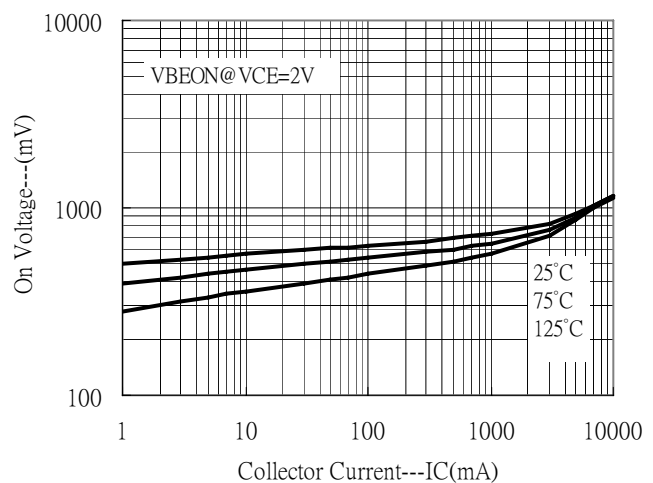



Typical Characteristics(Cont.)

Capacitance vs Reverse-biased Voltage

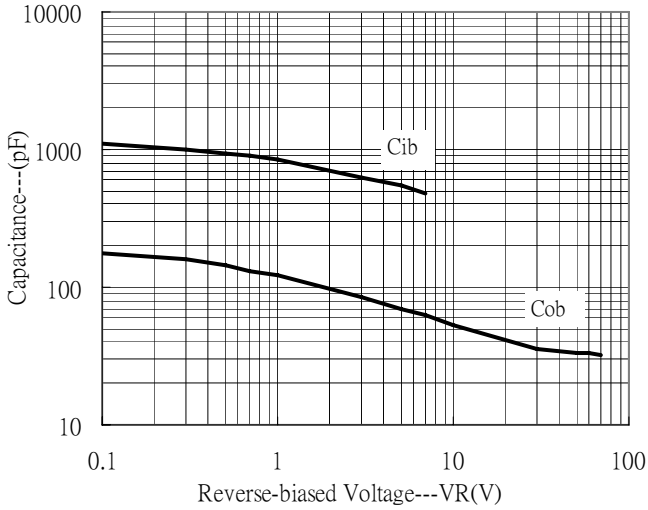

Power Derating Curve

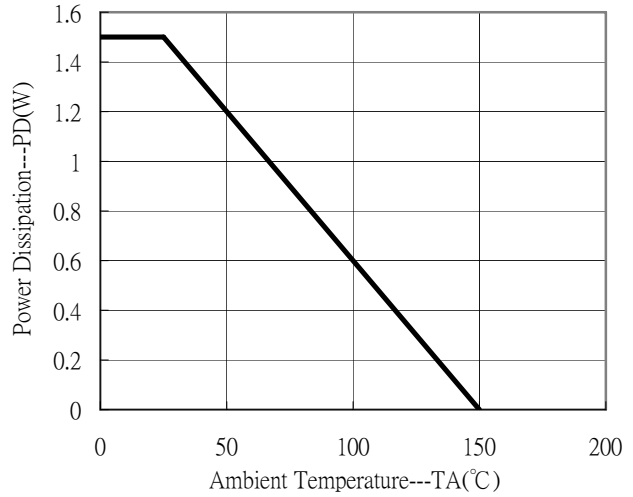

Power Derating Curve

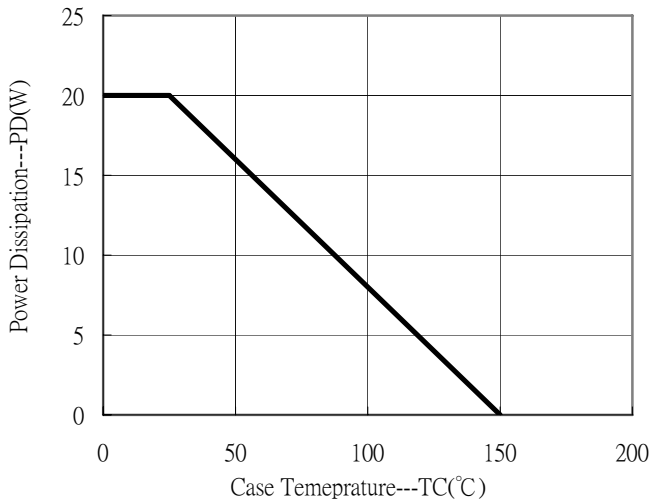

Ordering Information

Device	Package	Shipping
BTD1805AD3	TO-126ML (Pb-free lead plating package)	200 pcs / Bag, 15 Bags/Box, 10 Boxes/Carton

Recommended wave soldering condition

Product	Peak Temperature	Soldering Time
Pb-free devices	260 +0/-5 °C	5 +1/-1 seconds

Recommended temperature profile for IR reflow

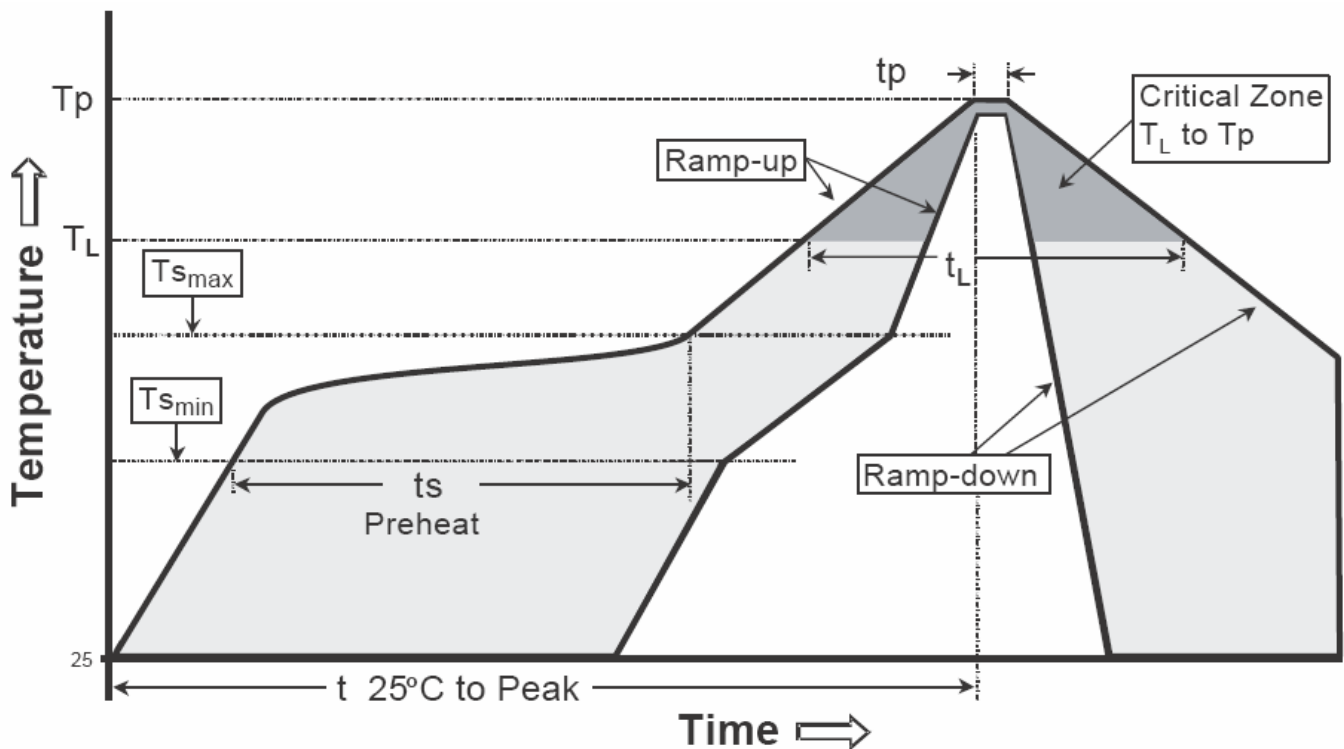

Profile feature	Sn-Pb eutectic Assembly	Pb-free Assembly
Average ramp-up rate (T _{smax} to T _p)	3°C/second max.	3°C/second max.
Preheat		
-Temperature Min(T _{s min})	100°C	150°C
-Temperature Max(T _{s max})	150°C	200°C
-Time(t _{s min} to t _{s max})	60-120 seconds	60-180 seconds
Time maintained above:		
-Temperature (T _L)	183°C	217°C
- Time (t _L)	60-150 seconds	60-150 seconds
Peak Temperature(T _P)	240 +0/-5 °C	260 +0/-5 °C
Time within 5°C of actual peak temperature(tp)	10-30 seconds	20-40 seconds
Ramp down rate	6°C/second max.	6°C/second max.
Time 25 °C to peak temperature	6 minutes max.	8 minutes max.

Note : All temperatures refer to topside of the package, measured on the package body surface.

TO-126ML Dimension

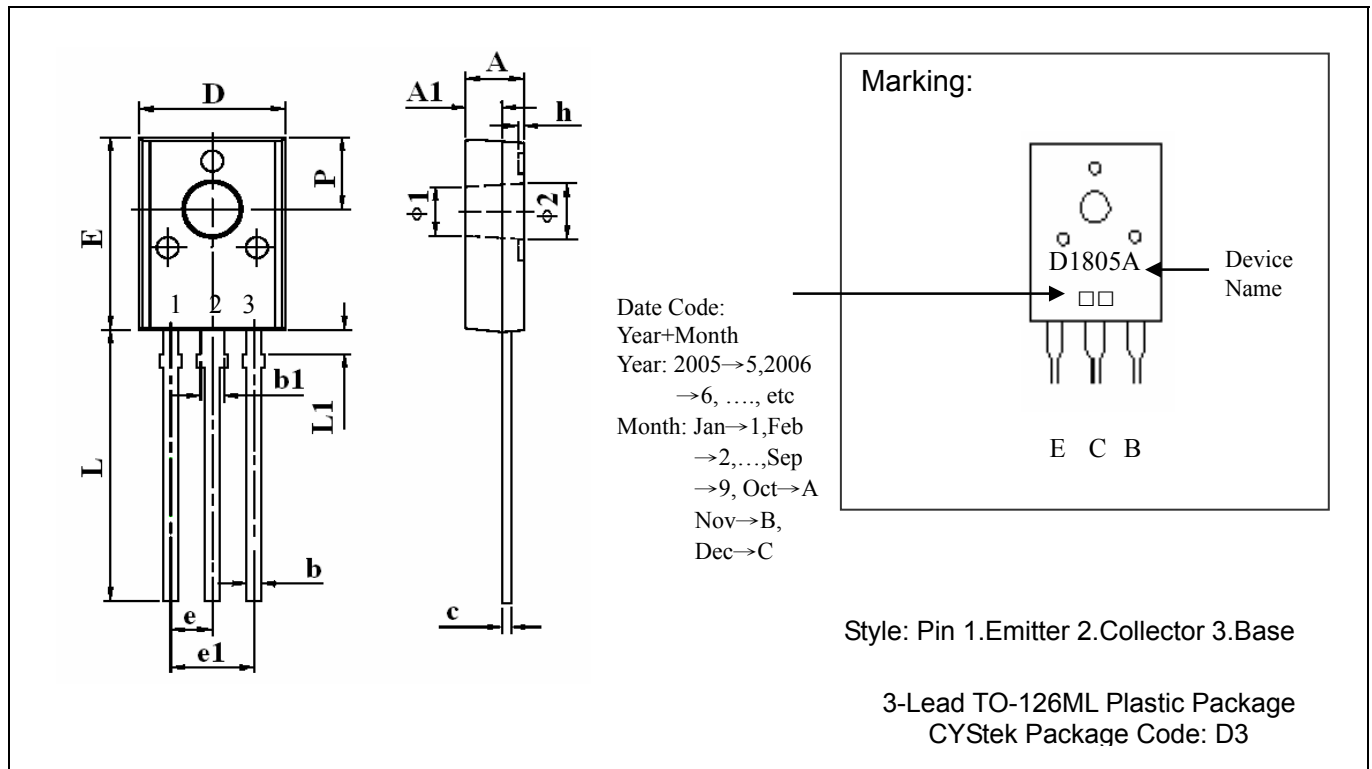

*: Typical

DIM	Inches		Millimeters		DIM	Inches		Millimeters	
	Min.	Max.	Min.	Max.		Min.	Max.	Min.	Max.
A	0.118	0.134	3.000	3.400	e	*0.090		*2.28	
A1	0.071	0.087	1.800	2.200	e1	0.176	0.183	4.460	4.660
b	0.026	0.034	0.660	0.860	L	0.594	0.610	15.100	15.500
b1	0.046	0.054	1.170	1.370	L1	0.051	0.059	1.300	1.500
c	0.018	0.024	0.450	0.600	P	0.159	0.167	4.040	4.240
D	0.307	0.323	7.800	8.200	Φ1	0.118	0.126	3.000	3.200
E	0.425	0.441	10.800	11.200	Φ2	0.122	0.130	3.100	3.300

Notes: 1. Controlling dimension: millimeters.
 2. Maximum lead thickness includes lead finish thickness, and minimum lead thickness is the minimum thickness of base material.
 3. If there is any question with packing specification or packing method, please contact your local CYStek sales office.

Material:

- Lead: Pure tin plated.
- Mold Compound: Epoxy resin family, flammability solid burning class: UL94V-0.

Important Notice:

- All rights are reserved. Reproduction in whole or in part is prohibited without the prior written approval of CYStek.
- CYStek reserves the right to make changes to its products without notice.
- CYStek **semiconductor products are not warranted to be suitable for use in Life-Support Applications, or systems.**
- CYStek assumes no liability for any consequence of customer product design, infringement of patents, or application assistance.