

**Low Vcesat PNP Epitaxial Planar Transistor**

# BTA3513J3

$BV_{CEO}$	-80V
$I_C$	-8A
$R_{CESAT}$	75m $\Omega$ typ.

**Features**

- Low  $V_{CE(sat)}$
- High  $BV_{CEO}$
- Excellent current gain characteristics
- RoHS compliant package

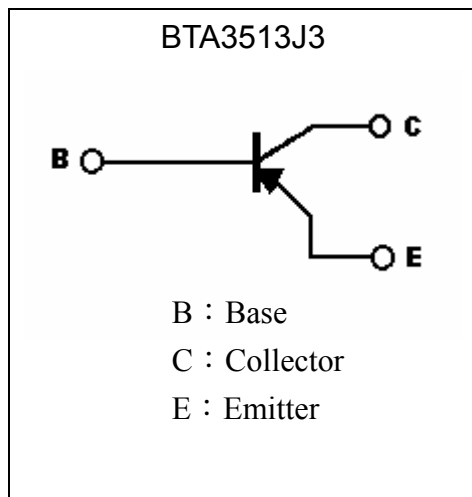
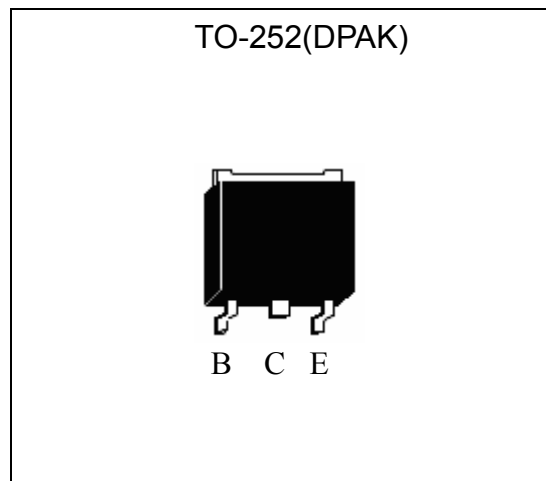
**Symbol**

**Outline**

**Absolute Maximum Ratings** ( $T_a=25^\circ\text{C}$ )

Parameter	Symbol	Limits	Unit
Collector-Base Voltage	$V_{CBO}$	-80	V
Collector-Emitter Voltage	$V_{CEO}$	-80	V
Emitter-Base Voltage	$V_{EBO}$	-5	V
Collector Current (DC)	$I_C$	-8	A
Collector Current (Pulse)	$I_{CP}$	-16 (Note 1)	
Power Dissipation @ $T_a=25^\circ\text{C}$	$P_D$	1.75 (Note 2)	W
Power Dissipation @ $T_c=25^\circ\text{C}$	$P_D$	20	
Thermal Resistance, Junction to Ambient	$R_{\theta JA}$	71.4 (Note 2)	$^\circ\text{C/W}$
Thermal Resistance, Junction to Case	$R_{\theta JC}$	6.25	$^\circ\text{C/W}$
Junction Temperature	$T_j$	150	$^\circ\text{C}$
Storage Temperature	$T_{stg}$	-55~+150	$^\circ\text{C}$

Note : 1. Single Pulse ,  $P_w \leq 300\mu\text{s}$ ,  $Duty \leq 2\%$ .  
 2. When mounted on a PCB with the minimum pad size.



**Characteristics (Ta=25°C)**

Symbol	Min.	Typ.	Max.	Unit	Test Conditions
BV <sub>CEO(SUS)</sub>	-80	-	-	V	I <sub>C</sub> =-30mA, I <sub>B</sub> =0
I <sub>CEO</sub>	-	-	-10	μA	V <sub>CE</sub> =-80V, I <sub>B</sub> =0
I <sub>CES</sub>	-	-	-10	μA	V <sub>CE</sub> =-80V, V <sub>BE</sub> =0
I <sub>EBO</sub>	-	-	-50	μA	V <sub>EB</sub> =-5V, I <sub>C</sub> =0
*V <sub>CE(sat)</sub> 1	-	-0.2	-0.3	V	I <sub>C</sub> =-3A, I <sub>B</sub> =-150mA
*V <sub>CE(sat)</sub> 2	-	-0.3	-0.5	V	I <sub>C</sub> =-4A, I <sub>B</sub> =-200mA
*V <sub>CE(sat)</sub> 3	-	-0.6	-1.0	V	I <sub>C</sub> =-8A, I <sub>B</sub> =-0.4A
*R <sub>CE(sat)</sub>	-	75	125	mΩ	I <sub>C</sub> =-8A, I <sub>B</sub> =-0.4A
*V <sub>BE(sat)</sub> 1	-	-0.85	-1.0	V	I <sub>C</sub> =-3A, I <sub>B</sub> =-150mA
*V <sub>BE(sat)</sub> 2	-	-0.9	-1.2	V	I <sub>C</sub> =-4A, I <sub>B</sub> =-200mA
*V <sub>BE(sat)</sub> 3	-	-1.0	-1.5	V	I <sub>C</sub> =-8A, I <sub>B</sub> =-0.8A
*h <sub>FE</sub> 1	160	-	-	-	V <sub>CE</sub> =-2V, I <sub>C</sub> =-500mA
*h <sub>FE</sub> 2	180	-	360	-	V <sub>CE</sub> =-2V, I <sub>C</sub> =-1A
*h <sub>FE</sub> 3	100	-	-	-	V <sub>CE</sub> =-2V, I <sub>C</sub> =-3A
f <sub>t</sub>	-	80	-	MHz	V <sub>CE</sub> =-10V, I <sub>C</sub> =-500mA, f=20MHz
C <sub>ob</sub>	-	98	-	pF	V <sub>CB</sub> =-10V, f=1MHz
ton	-	135	-	ns	I <sub>C</sub> =-5A, I <sub>B1</sub> =-I <sub>B2</sub> =-0.5A
tstg	-	500	-	ns	
tf	-	100	-	ns	

\*Pulse Test : Pulse Width ≤300μs, Duty Cycle ≤2%

**Ordering Information**

Device	Package	Shipping
BTA3513J3-0-T3-G	TO-252 (Pb-free lead plating and halogen-free package)	2500 pcs / Tape & Reel

**Typical Characteristics**

Emitter Grounded Output Characteristics

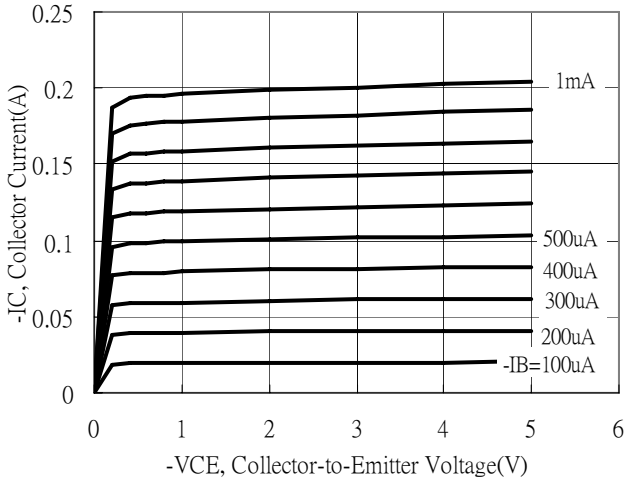

Emitter Grounded Output Characteristics

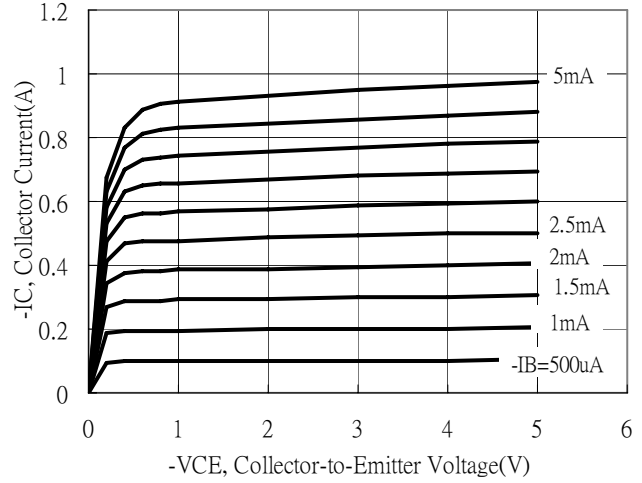

Emitter Grounded Output Characteristics

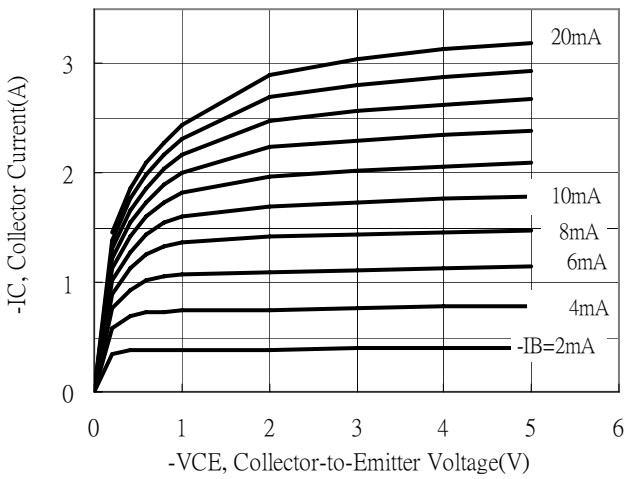

Emitter Grounded Output Characteristics

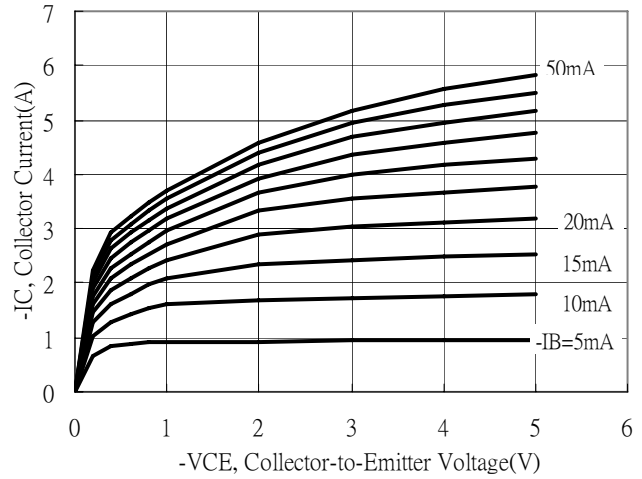

Current Gain vs Collector Current

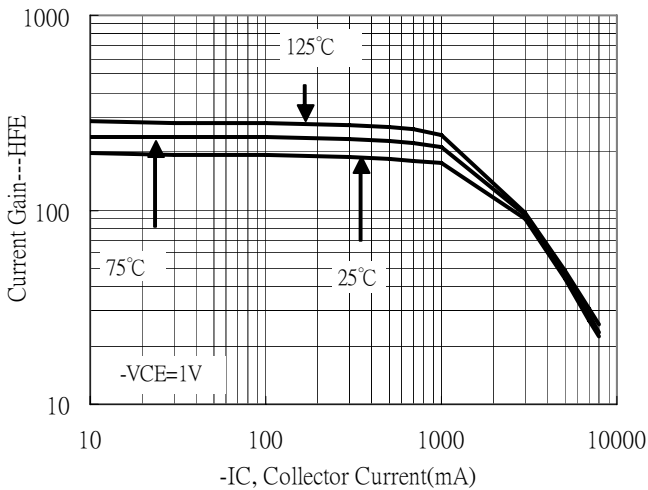

Current Gain vs Collector Current

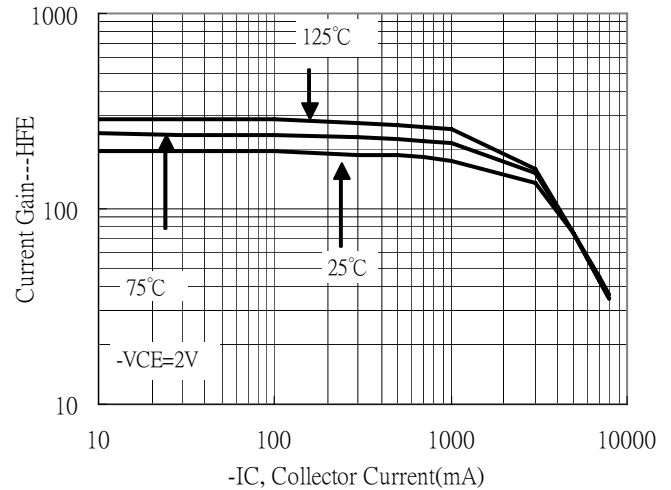

**Typical Characteristics(Cont.)**

Current Gain vs Collector Current

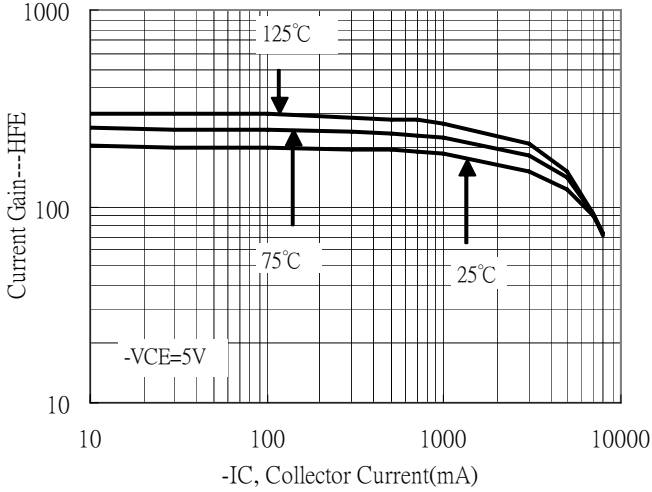

Saturation Voltage vs Collector Current

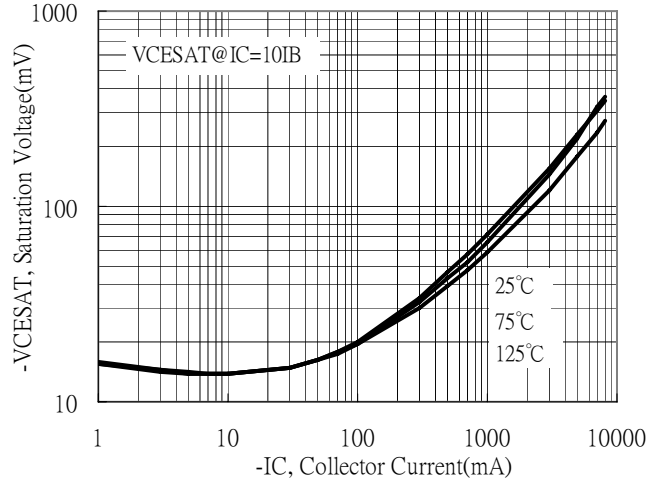

Saturation Voltage vs Collector Current

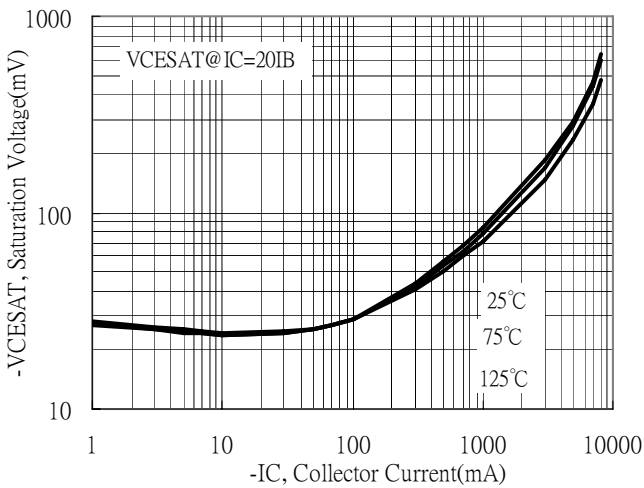

Saturation Voltage vs Collector Current

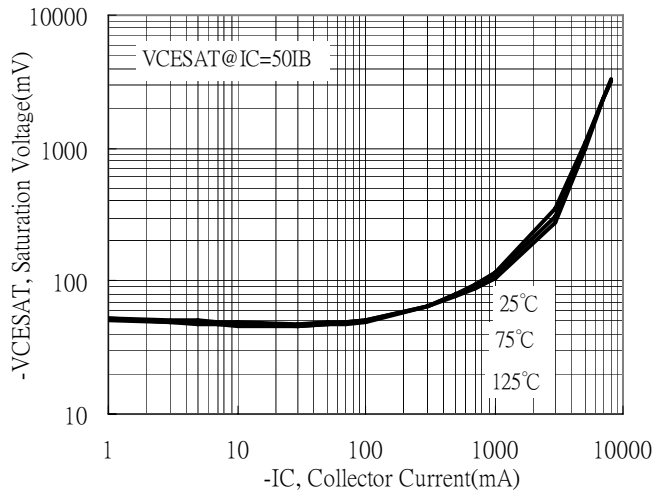

Saturation Voltage vs Collector Current

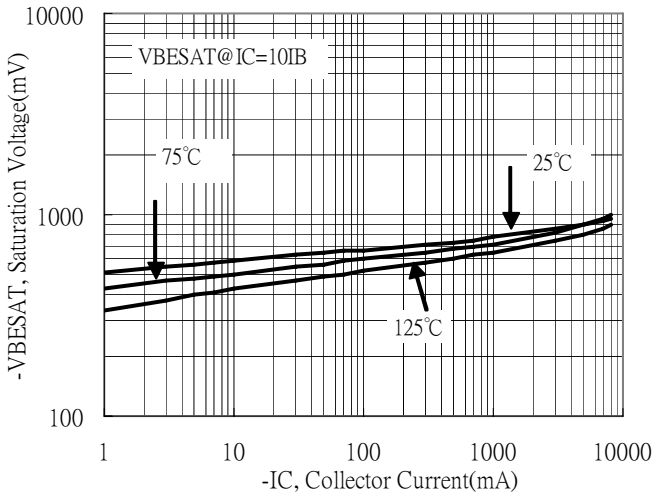

On Voltage vs Collector Current

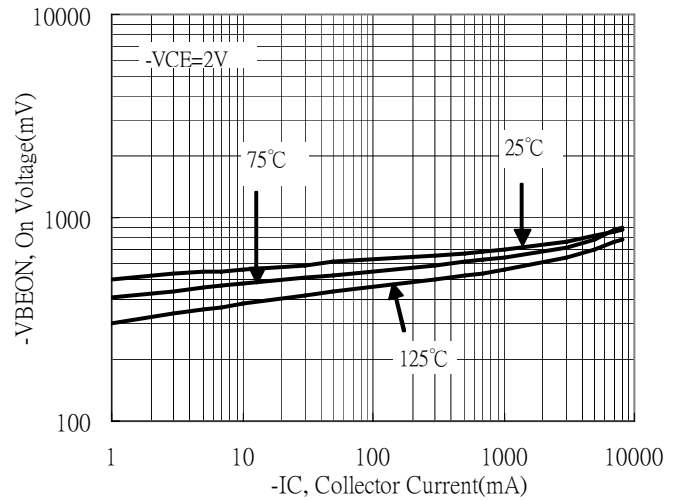



### Typical Characteristics(Cont.)

Capacitance vs Reverse-biased Voltage

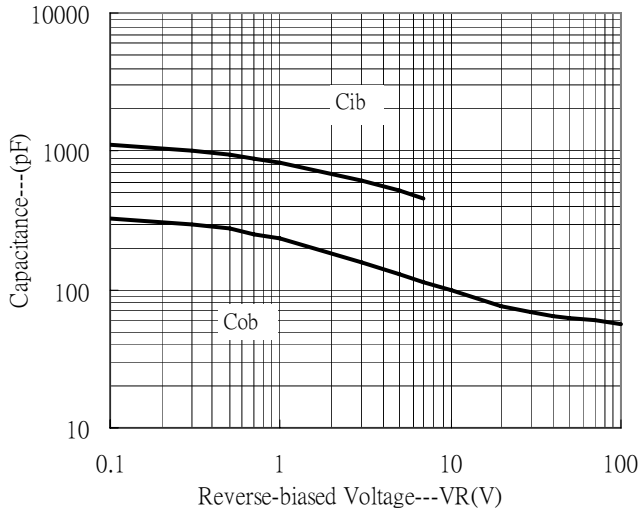

Power Derating Curve

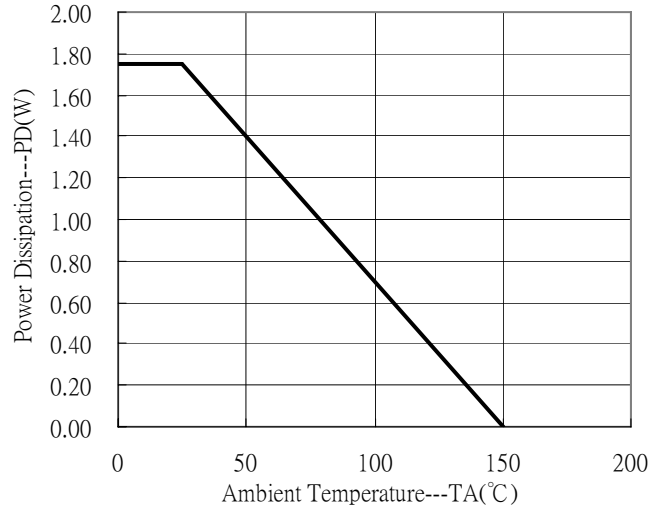

Power Derating Curve

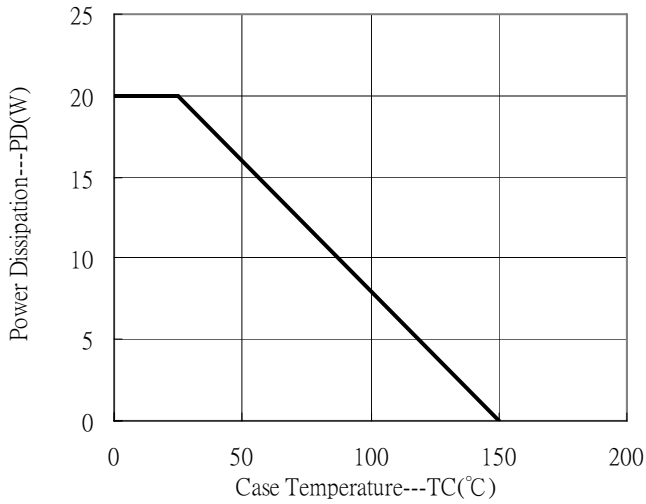

### Reel Dimension

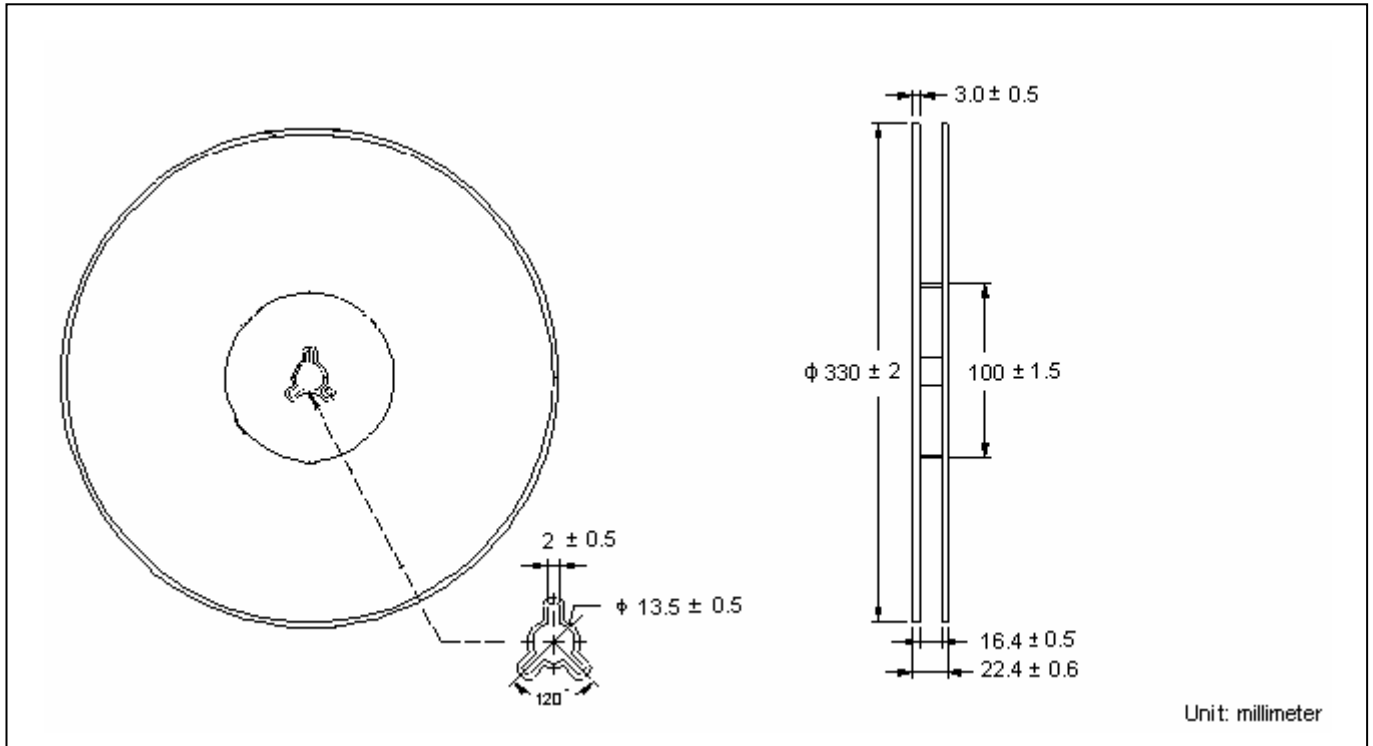

### Carrier Tape Dimension

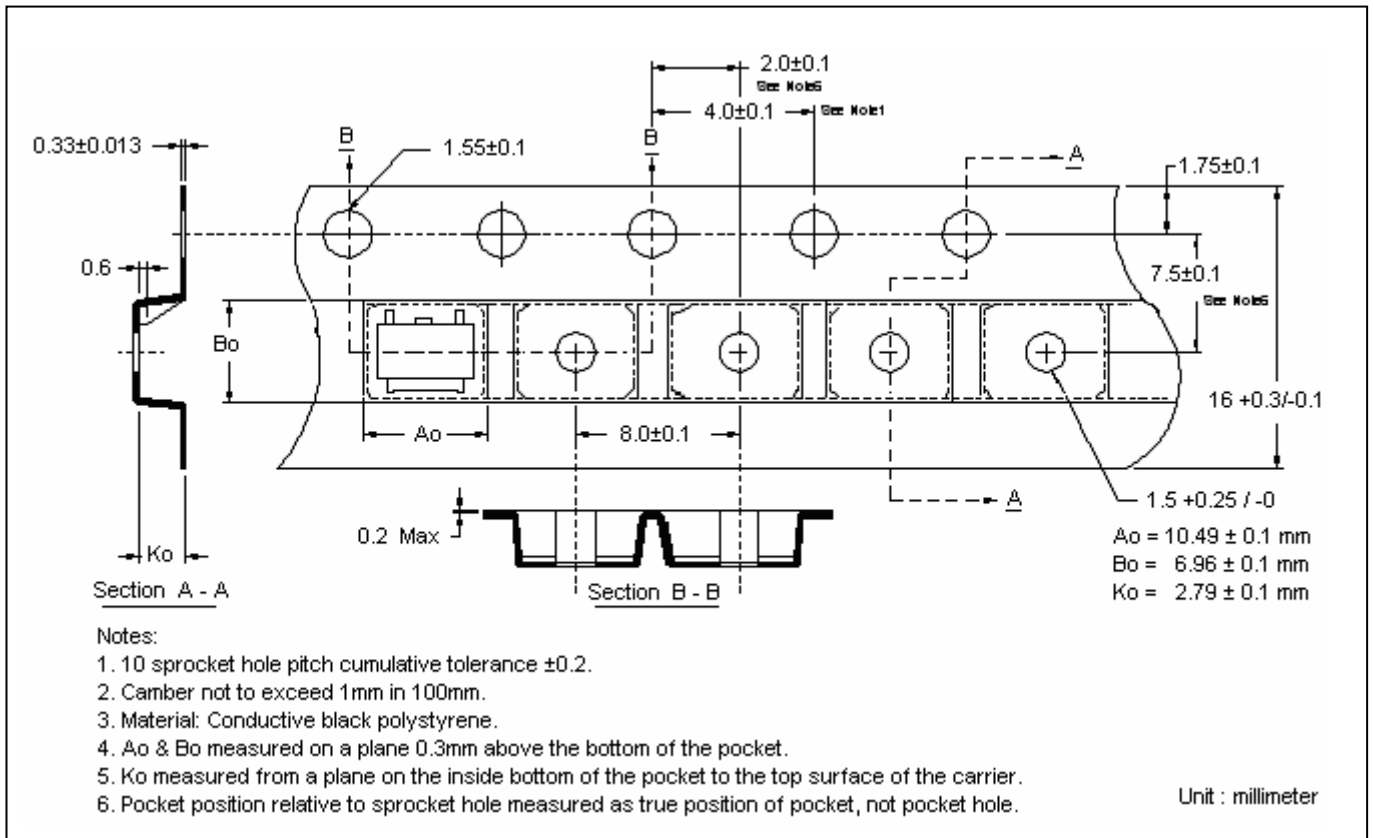

**Recommended wave soldering condition**

Product	Peak Temperature	Soldering Time
Pb-free devices	260 +0/-5 °C	5 +1/-1 seconds

**Recommended temperature profile for IR reflow**

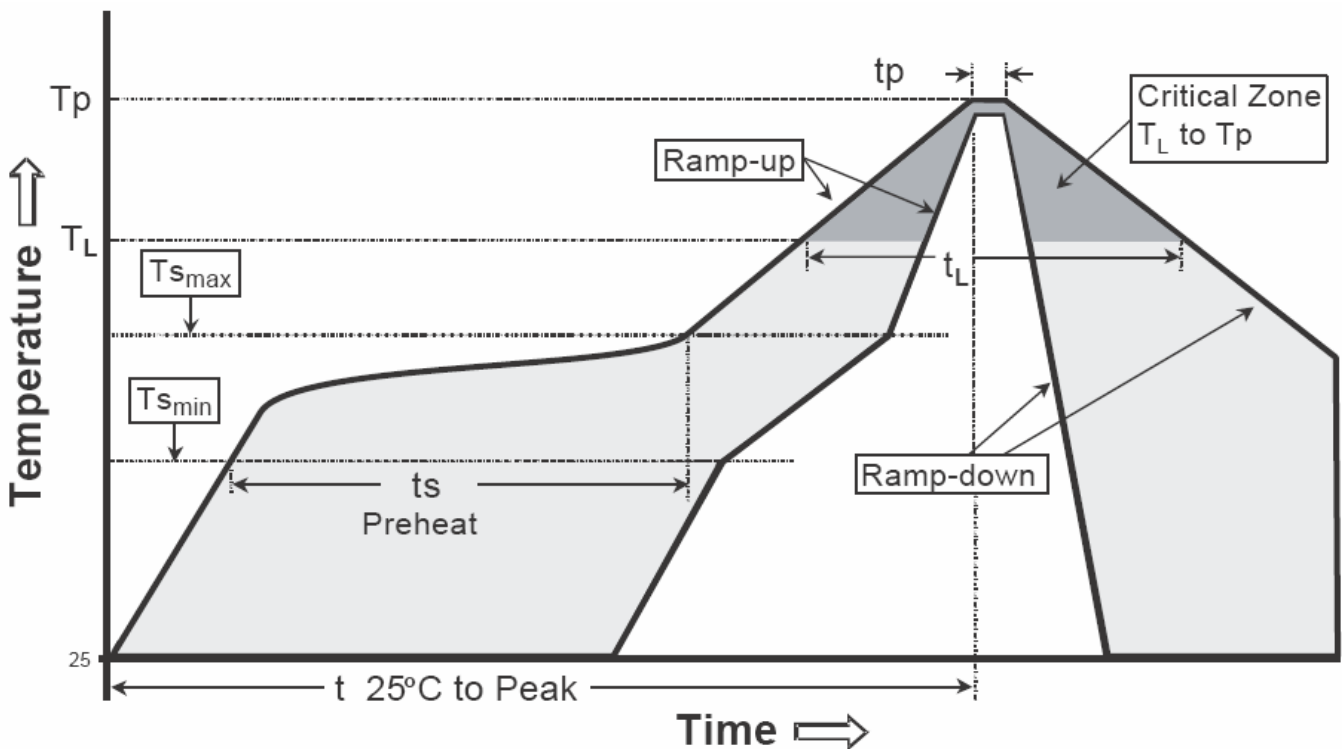

Profile feature	Sn-Pb eutectic Assembly	Pb-free Assembly
Average ramp-up rate (T <sub>smax</sub> to T <sub>p</sub> )	3°C/second max.	3°C/second max.
Preheat		
-Temperature Min(T <sub>s min</sub> )	100°C	150°C
-Temperature Max(T <sub>s max</sub> )	150°C	200°C
-Time(t <sub>s min</sub> to t <sub>s max</sub> )	60-120 seconds	60-180 seconds
Time maintained above:		
-Temperature (T <sub>L</sub> )	183°C	217°C
- Time (t <sub>L</sub> )	60-150 seconds	60-150 seconds
Peak Temperature(T <sub>P</sub> )	240 +0/-5 °C	260 +0/-5 °C
Time within 5°C of actual peak temperature(tp)	10-30 seconds	20-40 seconds
Ramp down rate	6°C/second max.	6°C/second max.
Time 25 °C to peak temperature	6 minutes max.	8 minutes max.

**TO-252 Dimension**

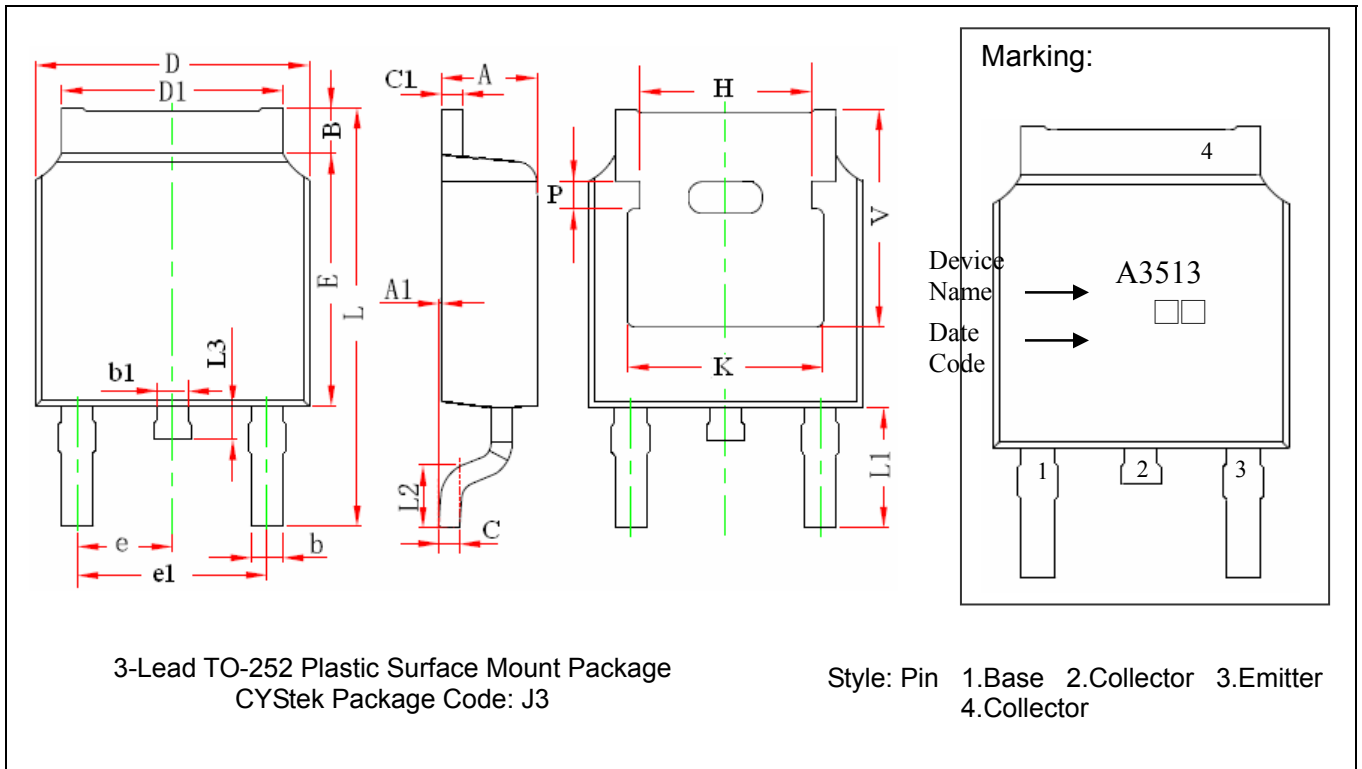

DIM	Inches		Millimeters		DIM	Inches		Millimeters	
	Min.	Max.	Min.	Max.		Min.	Max.	Min.	Max.
A	0.087	0.094	2.200	2.400	e	0.086	0.094	2.186	2.386
A1	0.000	0.005	0.000	0.127	e1	0.172	0.188	4.372	4.772
B	0.039	0.048	0.990	1.210	H	0.163	REF	4.140	REF
b	0.026	0.034	0.660	0.860	K	0.190	REF	4.830	REF
b1	0.026	0.034	0.660	0.860	L	0.386	0.409	9.800	10.400
C	0.018	0.023	0.460	0.580	L1	0.114	REF	2.900	REF
C1	0.018	0.023	0.460	0.580	L2	0.055	0.067	1.400	1.700
D	0.256	0.264	6.500	6.700	L3	0.024	0.039	0.600	1.000
D1	0.201	0.215	5.100	5.460	P	0.026	REF	0.650	REF
E	0.236	0.244	6.000	6.200	V	0.211	REF	5.350	REF

Notes: 1.Controlling dimension: millimeters.  
 2.Maximum lead thickness includes lead finish thickness, and minimum lead thickness is the minimum thickness of base material.  
 3.If there is any question with packing specification or packing method, please contact your local CYStek sales office.

**Material:**

- Lead : Pure tin plated.
- Mold Compound: Epoxy resin family, flammability solid burning class: UL94V-0.

**Important Notice:**

- All rights are reserved. Reproduction in whole or in part is prohibited without the prior written approval of CYStek.
- CYStek reserves the right to make changes to its products without notice.
- CYStek **semiconductor products are not warranted to be suitable for use in Life-Support Applications, or systems.**
- CYStek assumes no liability for any consequence of customer product design, infringement of patents, or application assistance.