

N-CHANNEL MOSFET

BSS123N3

BV _{DSS}		100V
I _D @V _{GS} =10V		1.7A
R _{DS(on)} (TYP)	V _{GS} =10V, I _D =700mA	290mΩ
	V _{GS} =4V, I _D =400mA	310mΩ
	V _{GS} =10V, I _D =170mA	260mΩ
	V _{GS} =4V, I _D =170mA	280mΩ

Description

The BSS123N3 is a N-channel enhancement-mode MOSFET.

Features

- Low on-resistance
- High speed switching
- Low-voltage drive(2.5V)
- Easily designed drive circuits
- Pb-free lead plating and halogen-free package

Symbol

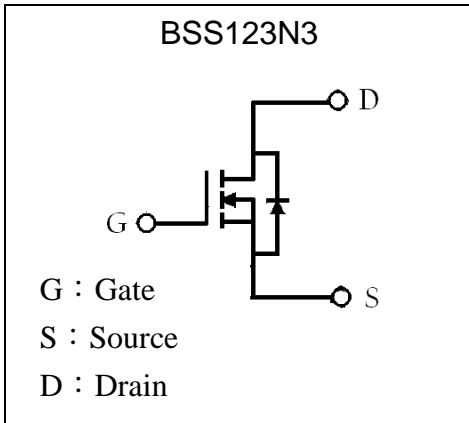

Outline

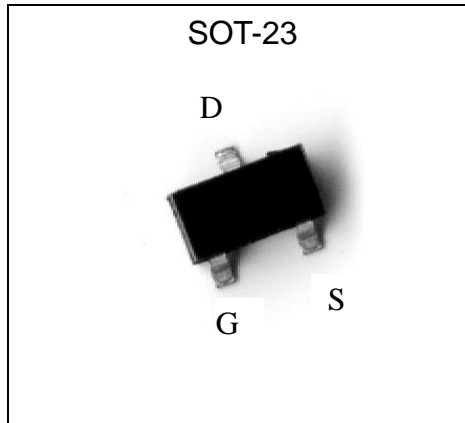

Ordering Information

Device	Package	Shipping
BSS123N3-0-T1-G	SOT-23 (Pb-free lead plating and halogen-free package)	3000 pcs / tape & reel

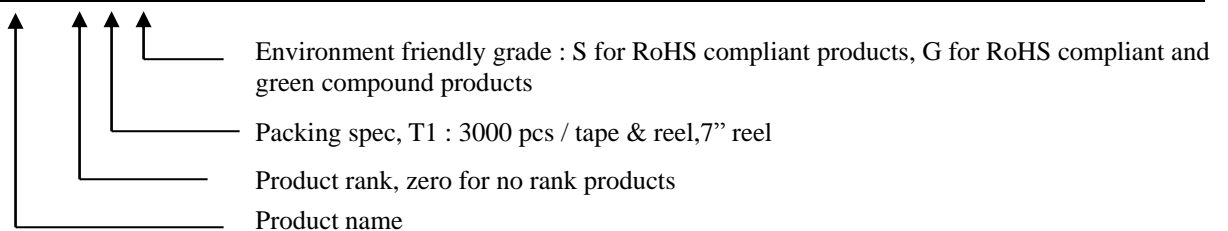



Absolute Maximum Ratings (Ta=25°C)

Parameter	Symbol	Limits	Unit
Drain-Source Voltage	V _{DSS}	100	V
Gate-Source Voltage	V _{GSS}	±30	V
Continuous Drain Current @ V _{GS} =10V	I _D	1.7	A
Pulsed Drain Current	I _{DP}	6.8 *1	A
Total Power Dissipation	P _D	1.38 *2	W
Channel Temperature	T _{CH}	+150	°C
Junction and Storage Temperature Range	T _j ; T _{stg}	-55~+150	°C

Note : *1. Pulse Width ≤ 300μs, Duty cycle ≤ 2%

*2. When the device is surface mounted on 1 in² copper pad of FR-4 board with 2 oz. copper.

Thermal Performance

Parameter	Symbol	Limit	Unit
Thermal Resistance, Junction-to-Ambient	R _{th,ja}	90	°C/W

Note : Surface mounted on 1 in² copper pad of FR-4 board, 350°C/W when mounted on minimum copper pad.

Electrical Characteristics (Ta=25°C)

Symbol	Min.	Typ.	Max.	Unit	Test Conditions
Static					
BV _{DSS} *	100	-	-	V	V _{GS} =0, I _D =10μA
V _{GS(th)}	1	-	2.5	V	V _{DS} =V _{GS} , I _D =250μA
I _{GSS}	-	-	±100	nA	V _{GS} =±30V, V _{DS} =0
I _{DSS}	-	-	1	μA	V _{DS} =100V, V _{GS} =0
R _{DS(ON)} *	-	290	400	mΩ	I _D =700mA, V _{GS} =10V
	-	310	450		I _D =400mA, V _{GS} =4V
	-	260	400		I _D =170mA, V _{GS} =10V
	-	280	400		I _D =170mA, V _{GS} =4V
G _{FS}	0.08	1	-	S	V _{DS} =10V, I _D =170mA
Dynamic					
C _{iss}	-	512	-	pF	V _{DS} =25V, V _{GS} =0, f=1MHz
C _{OSS}	-	15	-		
C _{rss}	-	11	-		
td(ON)	-	3.1	-	ns	V _{DD} =30V, I _D =1.7A, V _{GS} =10V, R _{GEN} =6Ω
tr	-	1.2	-		
td(OFF)	-	9.7	-		
tf	-	1.4	-		
Q _g	-	3.6	-	nC	V _{DD} =30V, I _D =1.7A, V _{GS} =10V
Q _{gs}	-	1.8	-		
Q _{gd}	-	0.6	-		

Source-Drain Diode					
*I _S	-	-	1.7	A	V _{GS} =0V, I _{SD} =1A
*I _{SM}	-	-	6.8		
*V _{SD}	-	-	1.2	V	

*Pulse Test : Pulse Width ≤380μs, Duty Cycle≤2%

Recommended Soldering Footprint

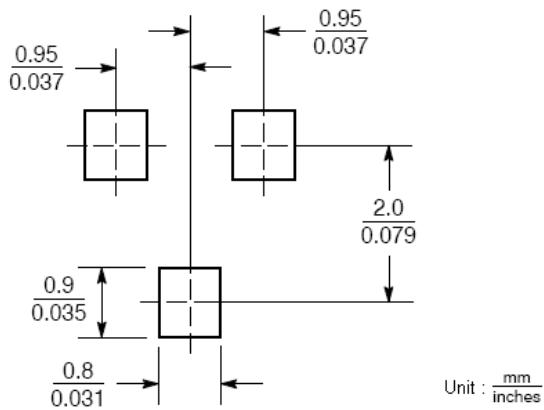

Typical Characteristics

Typical Output Characteristics

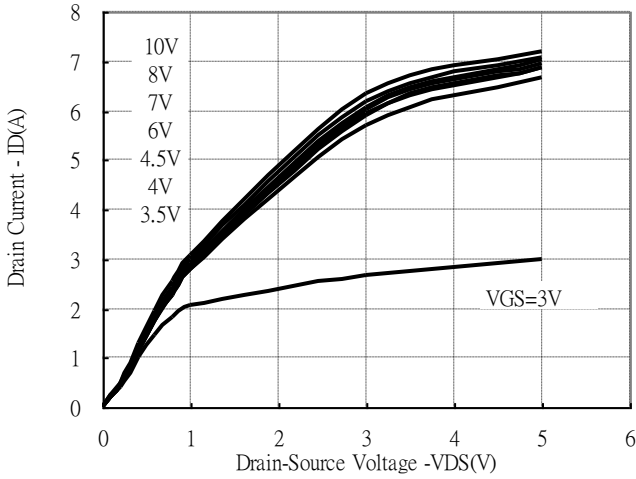

Breakdown Voltage vs Junction Temperature

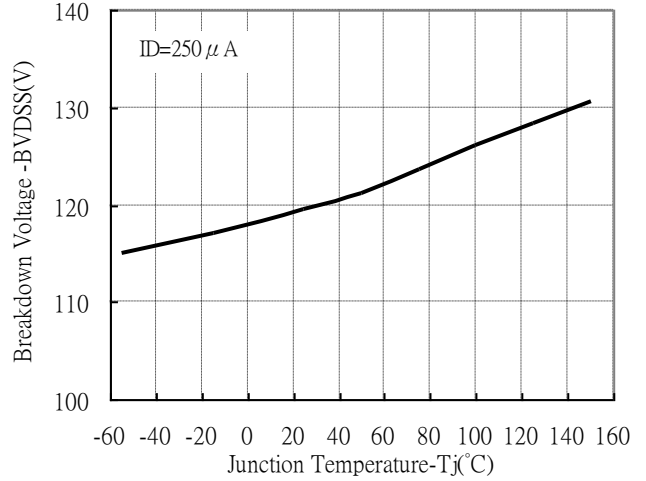

Static Drain-Source On-State resistance vs Drain Current

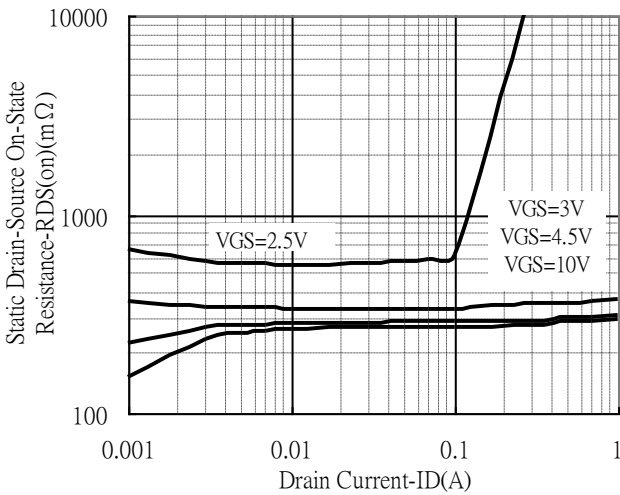

Reverse Drain Current vs Source-Drain Voltage

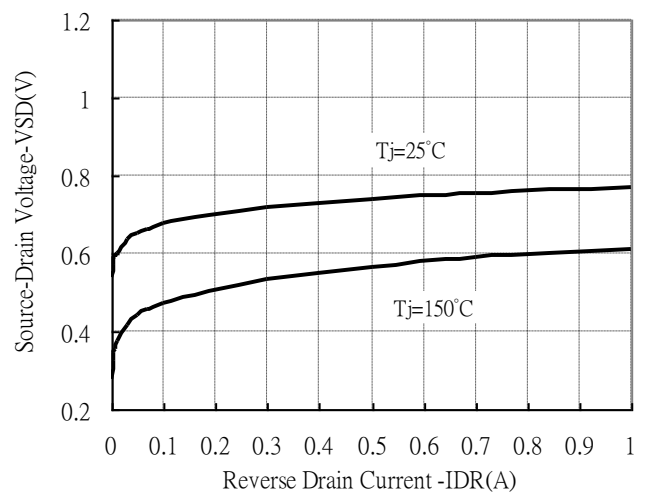

Static Drain-Source On-State Resistance vs Gate-Source Voltage

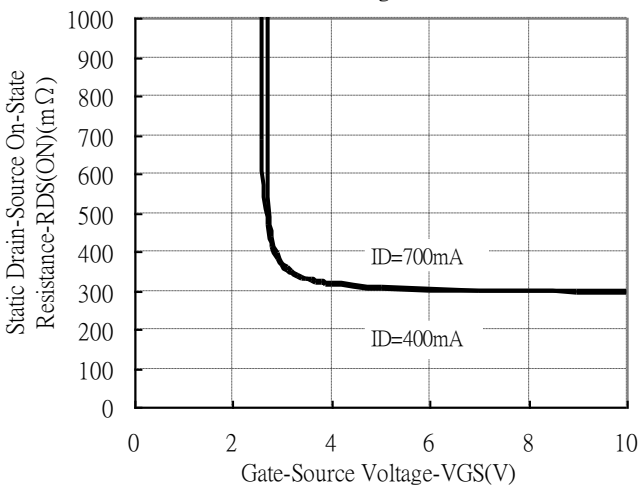

Drain-Source On-State Resistance vs Junction Temperature

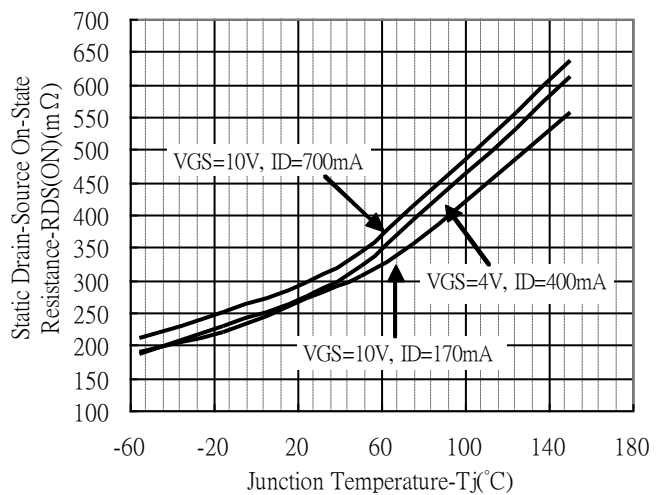



Typical Characteristics(Cont.)

Capacitance vs Drain-to-Source Voltage

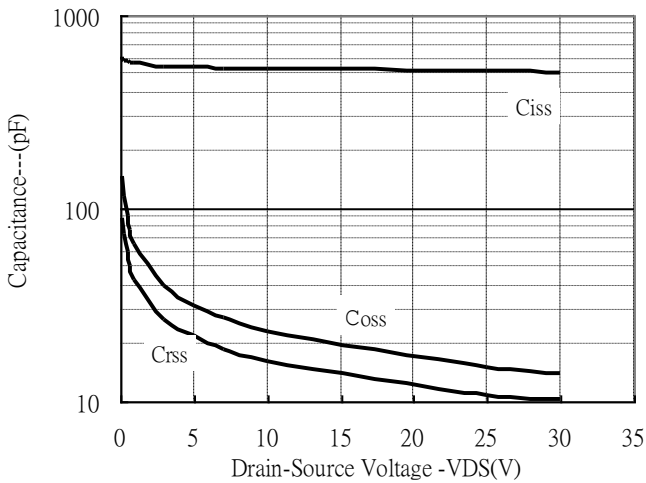

Threshold Voltage vs Junction Temperature

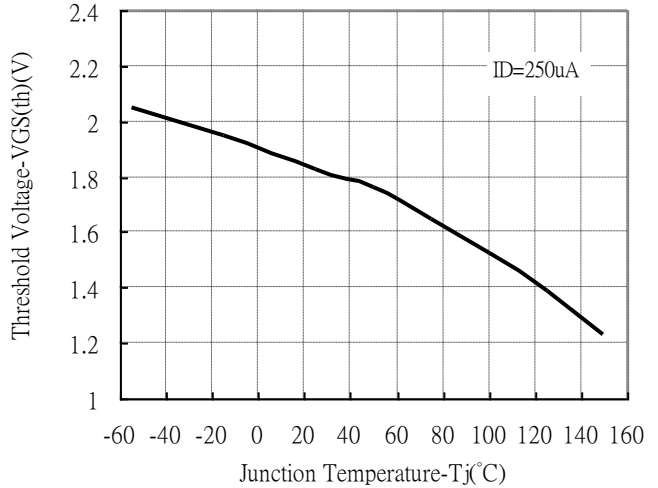

Gate Charge Characteristics

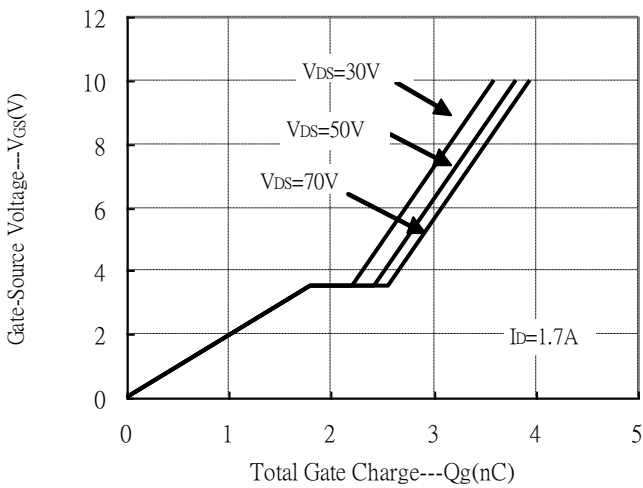

Typical Transfer Characteristics

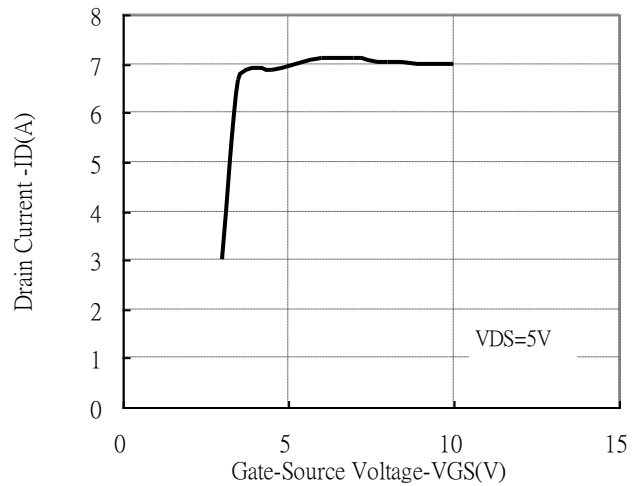

Maximum Safe Operating Area

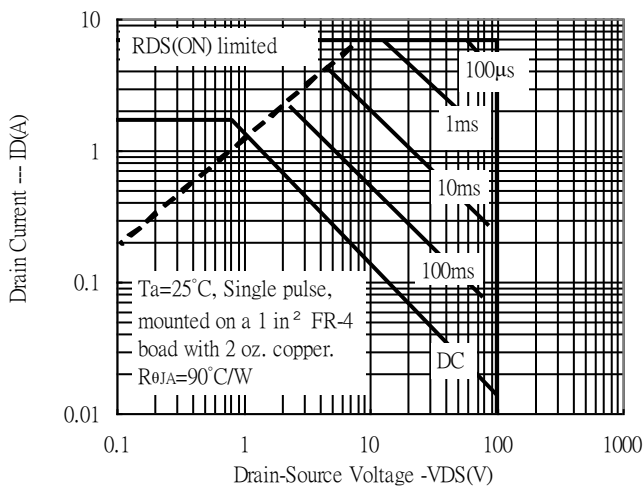

Power Derating Curve

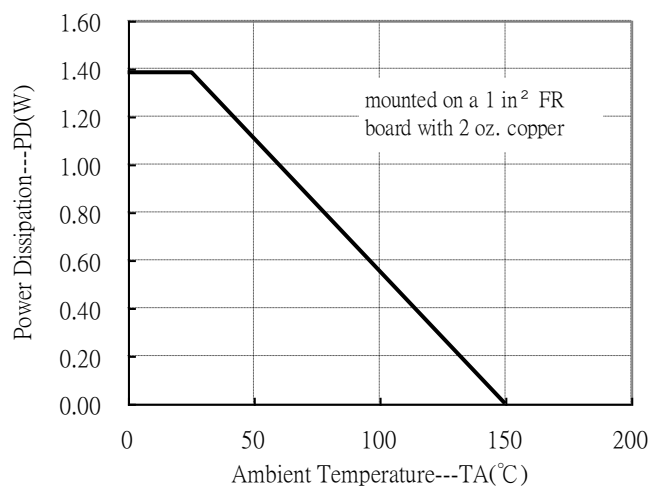

Reel Dimension



Carrier Tape Dimension

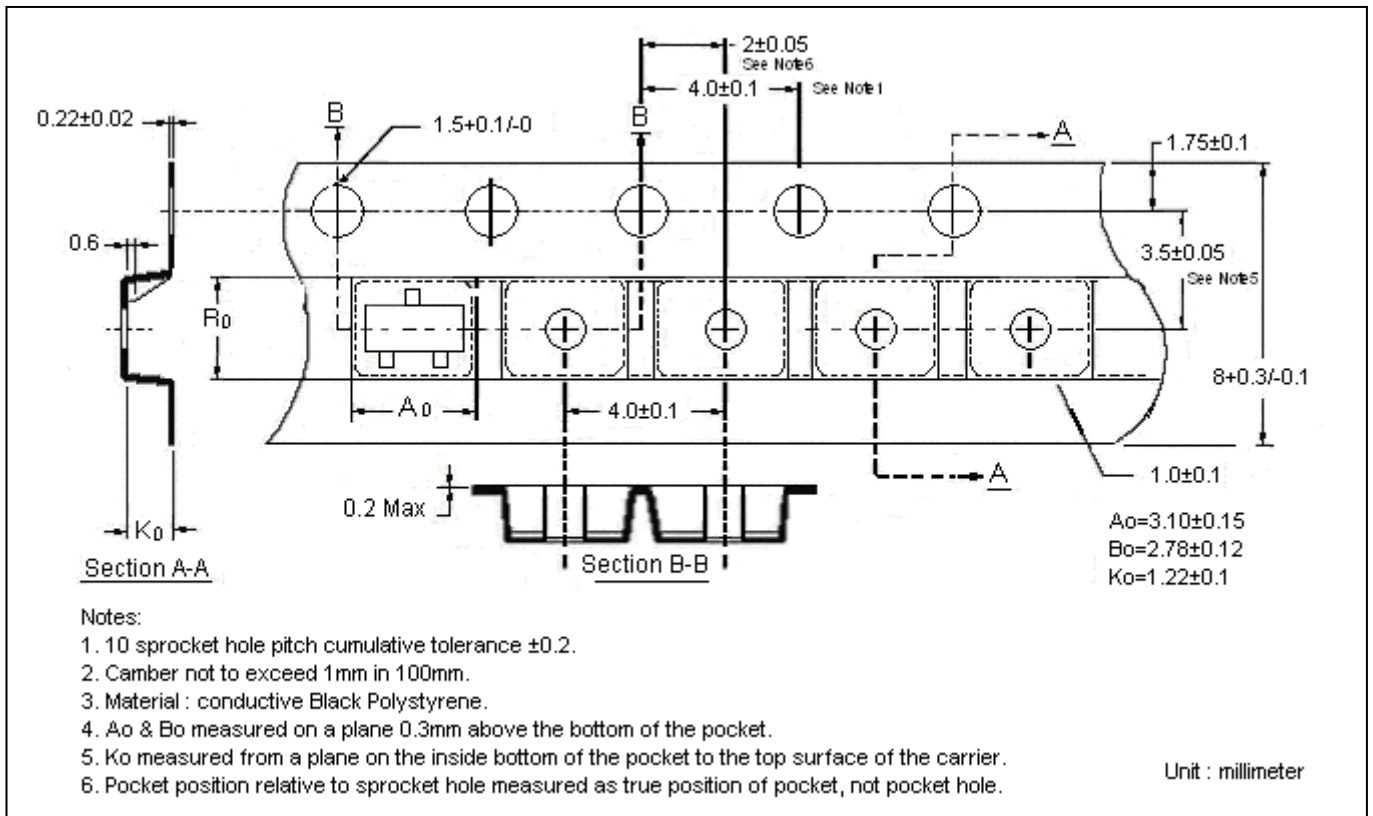

Recommended wave soldering condition

Product	Peak Temperature	Soldering Time
Pb-free devices	260 +0/-5 °C	5 +1/-1 seconds

Recommended temperature profile for IR reflow

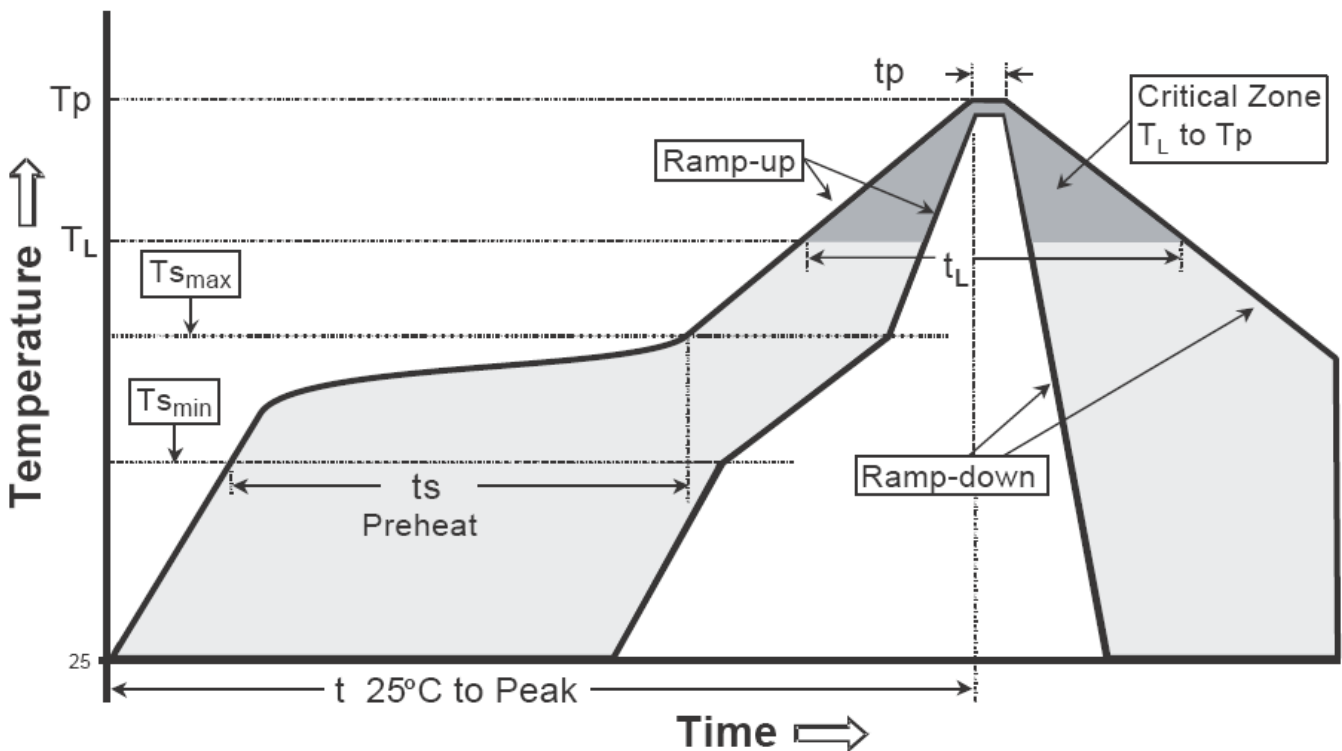

Profile feature	Sn-Pb eutectic Assembly	Pb-free Assembly
Average ramp-up rate (Tsmax to Tp)	3°C/second max.	3°C/second max.
Preheat		
-Temperature Min(Ts min)	100°C	150°C
-Temperature Max(Ts max)	150°C	200°C
-Time(ts min to ts max)	60-120 seconds	60-180 seconds
Time maintained above:		
-Temperature (TL)	183°C	217°C
- Time (tL)	60-150 seconds	60-150 seconds
Peak Temperature(TP)	240 +0/-5 °C	260 +0/-5 °C
Time within 5°C of actual peak temperature(tp)	10-30 seconds	20-40 seconds
Ramp down rate	6°C/second max.	6°C/second max.
Time 25 °C to peak temperature	6 minutes max.	8 minutes max.

Note : All temperatures refer to topside of the package, measured on the package body surface.

SOT-23 Dimension

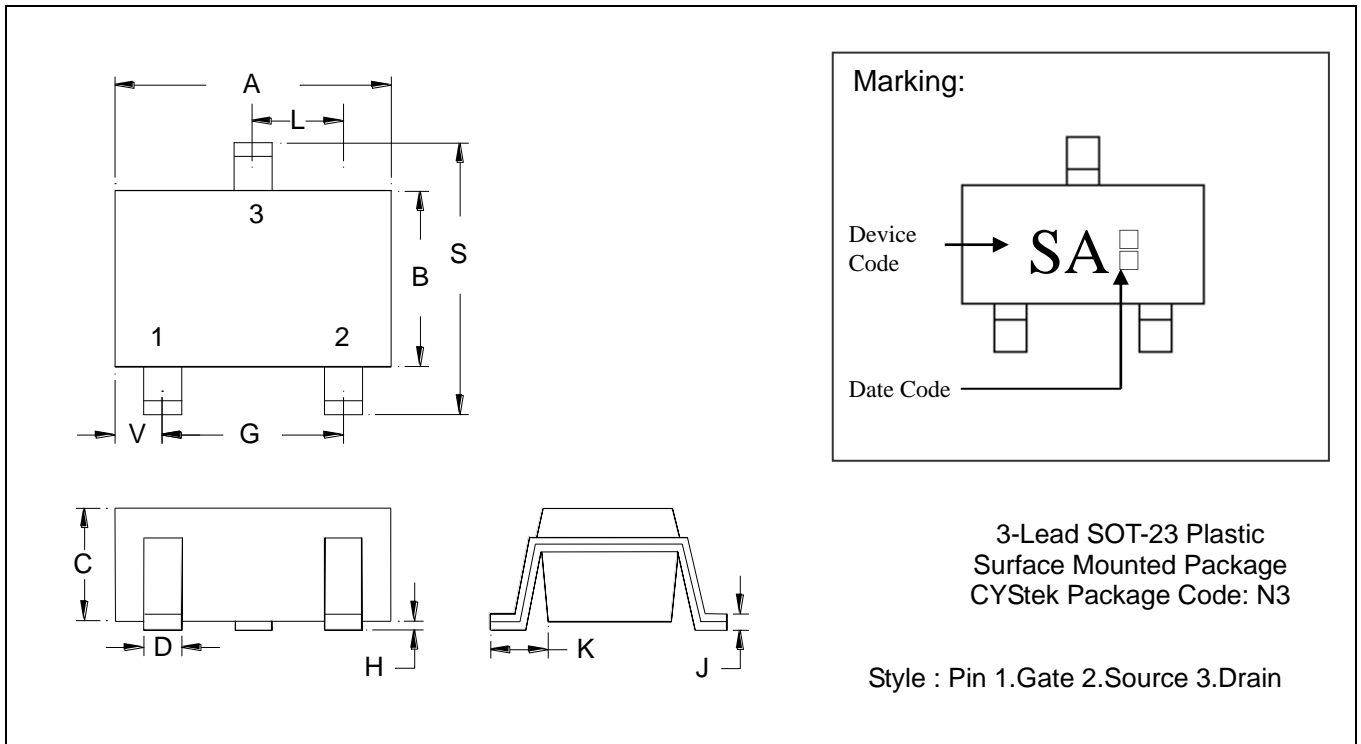

*:Typical

DIM	Inches		Millimeters		DIM	Inches		Millimeters	
	Min.	Max.	Min.	Max.		Min.	Max.	Min.	Max.
A	0.1102	0.1204	2.80	3.04	J	0.0035	0.0071	0.09	0.18
B	0.0472	0.0669	1.20	1.70	K	0.0276	REF	0.70	REF
C	0.0335	0.0512	0.89	1.30	L	0.0374*		0.95*	
D	0.0118	0.0197	0.30	0.50	S	0.0830	0.1161	2.10	2.95
G	0.0669	0.0910	1.70	2.30	V	0.0098	0.0256	0.25	0.65
H	0.0004	0.0040	0.01	0.10					

Notes : 1.Controlling dimension : millimeters.
 2.Maximum lead thickness includes lead finish thickness, and minimum lead thickness is the minimum thickness of base material.
 3.If there is any question with packing specification or packing method, please contact your local CYStek sales office.

Material :

- Lead : Pure tin plated.
- Mold Compound : Epoxy resin family, flammability solid burning class:UL94V-0.

Important Notice:

- All rights are reserved. Reproduction in whole or in part is prohibited without the prior written approval of CYStek.
- CYStek reserves the right to make changes to its products without notice.
- CYStek **semiconductor products are not warranted to be suitable for use in Life-Support Applications, or systems.**
- CYStek assumes no liability for any consequence of customer product design, infringement of patents, or application assistance.