



**AO4916, AO4916L( Green Product )**  
**Dual N-Channel Enhancement Mode Field Effect Transistor**  
**with Schottky Diode**

**General Description**

The AO4916 uses advanced trench technology to provide excellent  $R_{DS(ON)}$  and low gate charge. The two MOSFETs make a compact and efficient switch and synchronous rectifier combination for use in DC-DC converters. A Schottky diode is co-packaged in parallel with the synchronous MOSFET to boost efficiency further. AO4916L ( Green Product ) is offered in a lead-free package.

**Features**

$V_{DS} (V) = 30V$   
 $I_D = 8.5A$   
 $R_{DS(ON)} < 17m\Omega (V_{GS} = 10V)$   
 $R_{DS(ON)} < 27m\Omega (V_{GS} = 4.5V)$

**SCHOTTKY**

$V_{DS} (V) = 30V, I_F = 3A, V_F=0.5V@1A$

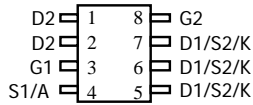

**SOIC-8**

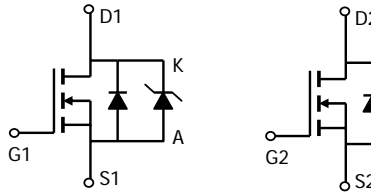

**Absolute Maximum Ratings  $T_A=25^\circ C$  unless otherwise noted**

Parameter	Symbol	MOSFET	Schottky	Units
Drain-Source Voltage	$V_{DS}$	30		V
Gate-Source Voltage	$V_{GS}$	$\pm 20$		V
Continuous Drain Current <sup>A</sup>	$I_D$	$T_A=25^\circ C$	8.5	A
		$T_A=70^\circ C$	6.6	
Pulsed Drain Current <sup>B</sup>	$I_{DM}$	40		
Schottky reverse voltage	$V_{KA}$		30	V
Continuous Forward Current <sup>A</sup>	$I_F$	$T_A=25^\circ C$	3	A
		$T_A=70^\circ C$	2	
Pulsed Forward Current <sup>B</sup>	$I_{FM}$		40	
Power Dissipation	$P_D$	$T_A=25^\circ C$	2	W
		$T_A=70^\circ C$	1.28	
Junction and Storage Temperature Range	$T_J, T_{STG}$	-55 to 150	-55 to 150	$^\circ C$

Parameter: Thermal Characteristics MOSFET		Symbol	Typ	Max	Units
Maximum Junction-to-Ambient <sup>A</sup>	$t \leq 10s$	$R_{\theta JA}$	48	62.5	$^\circ C/W$
Maximum Junction-to-Ambient <sup>A</sup>	Steady-State		74	110	
Maximum Junction-to-Lead <sup>C</sup>	Steady-State	$R_{\theta JL}$	35	40	
Thermal Characteristics Schottky					
Maximum Junction-to-Ambient <sup>A</sup>	$t \leq 10s$	$R_{\theta JA}$	47.5	62.5	$^\circ C/W$
Maximum Junction-to-Ambient <sup>A</sup>	Steady-State		71	110	
Maximum Junction-to-Lead <sup>C</sup>	Steady-State	$R_{\theta JL}$	32	40	

Electrical Characteristics ( $T_J=25^\circ\text{C}$  unless otherwise noted)

Symbol	Parameter	Conditions	Min	Typ	Max	Units
<b>STATIC PARAMETERS</b>						
$BV_{DSS}$	Drain-Source Breakdown Voltage	$I_D=250\mu\text{A}$ , $V_{GS}=0\text{V}$	30			V
$I_{DSS}$	Zero Gate Voltage Drain Current	$V_{DS}=24\text{V}$ , $V_{GS}=0\text{V}$ $T_J=55^\circ\text{C}$		0.005	1	$\mu\text{A}$
$I_{GSS}$	Gate-Body leakage current	$V_{DS}=0\text{V}$ , $V_{GS}=\pm 20\text{V}$			100	nA
$V_{GS(th)}$	Gate Threshold Voltage	$V_{DS}=V_{GS}$ , $I_D=250\mu\text{A}$	1	1.8	3	V
$I_{D(ON)}$	On state drain current	$V_{GS}=10\text{V}$ , $V_{DS}=5\text{V}$	40			A
$R_{DS(ON)}$	Static Drain-Source On-Resistance	$V_{GS}=10\text{V}$ , $I_D=8.5\text{A}$ $T_J=125^\circ\text{C}$		14	17	$\text{m}\Omega$
		$V_{GS}=4.5\text{V}$ , $I_D=6\text{A}$		20	25	$\text{m}\Omega$
$g_{FS}$	Forward Transconductance	$V_{DS}=5\text{V}$ , $I_D=8.5\text{A}$		23		S
$V_{SD}$	Diode Forward Voltage	$I_S=1\text{A}$ , $V_{GS}=0\text{V}$		0.76	1	V
$I_S$	Maximum Body-Diode Continuous Current				3	A
<b>DYNAMIC PARAMETERS</b>						
$C_{iss}$	Input Capacitance			1040	1250	pF
$C_{oss}$	Output Capacitance	$V_{GS}=0\text{V}$ , $V_{DS}=15\text{V}$ , $f=1\text{MHz}$		180		pF
$C_{rss}$	Reverse Transfer Capacitance			110		pF
$R_g$	Gate resistance	$V_{GS}=0\text{V}$ , $V_{DS}=0\text{V}$ , $f=1\text{MHz}$	0.35	0.7	0.85	$\Omega$
<b>SWITCHING PARAMETERS</b>						
$Q_g(10\text{V})$	Total Gate Charge			19.2	24	nC
$Q_g(4.5\text{V})$	Total Gate Charge	$V_{GS}=10\text{V}$ , $V_{DS}=15\text{V}$ , $I_D=8.5\text{A}$		9.36	12	nC
$Q_{gs}$	Gate Source Charge			2.6		nC
$Q_{gd}$	Gate Drain Charge			4.2		nC
$t_{D(on)}$	Turn-On DelayTime			5.2	7.5	ns
$t_r$	Turn-On Rise Time	$V_{GS}=10\text{V}$ , $V_{DS}=15\text{V}$ , $R_L=1.8\Omega$ , $R_{GEN}=3\Omega$		4.4	6.5	ns
$t_{D(off)}$	Turn-Off DelayTime			17.3	25	ns
$t_f$	Turn-Off Fall Time			3.3	5	ns
$t_{rr}$	Body Diode Reverse Recovery Time	$I_F=8.5\text{A}$ , $di/dt=100\text{A}/\mu\text{s}$		16.7	21	ns
$Q_{rr}$	Body Diode Reverse Recovery Charge	$I_F=8.5\text{A}$ , $di/dt=100\text{A}/\mu\text{s}$		9.3	11	nC
<b>SCHOTTKY PARAMETERS</b>						
$V_F$	Forward Voltage Drop	$I_F=1.0\text{A}$		0.45	0.5	V
$I_{rm}$	Maximum reverse leakage current	$V_R=30\text{V}$		0.007	0.05	mA
		$V_R=30\text{V}$ , $T_J=125^\circ\text{C}$		3.2	10	
		$V_R=30\text{V}$ , $T_J=150^\circ\text{C}$		12	20	
$C_T$	Junction Capacitance	$V_R=15\text{V}$		37		pF

A: The value of  $R_{\theta JA}$  is measured with the device mounted on 1 in<sup>2</sup> FR-4 board with 2oz. Copper, in a still air environment with  $T_A=25^\circ\text{C}$ . The value in any a given application depends on the user's specific board design. The current rating is based on the  $t \leq 10\text{s}$  thermal resistance rating.

B: Repetitive rating, pulse width limited by junction temperature.

C: The  $R_{\theta JA}$  is the sum of the thermal impedance from junction to lead  $R_{\theta JL}$  and lead to ambient.

D: The static characteristics in Figures 1 to 6 are obtained using 80  $\mu\text{s}$  pulses, duty cycle 0.5% max.

E: These tests are performed with the device mounted on 1 in<sup>2</sup> FR-4 board with 2oz. Copper, in a still air environment with  $T_A=25^\circ\text{C}$ . The SOA curve provides a single pulse rating.

THIS PRODUCT HAS BEEN DESIGNED AND QUALIFIED FOR THE CONSUMER MARKET. APPLICATIONS OR USES AS CRITICAL COMPONENTS IN LIFE SUPPORT DEVICES OR SYSTEMS ARE NOT AUTHORIZED. AOS DOES NOT ASSUME ANY LIABILITY ARISING OUT OF SUCH APPLICATIONS OR USES OF ITS PRODUCTS. AOS RESERVES THE RIGHT TO IMPROVE PRODUCT DESIGN, FUNCTIONS AND RELIABILITY WITHOUT NOTICE.

TYPICAL ELECTRICAL AND THERMAL CHARACTERISTICS

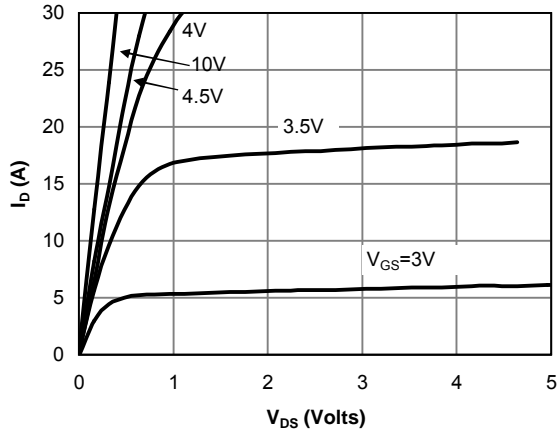

Fig 1: On-Region Characteristics

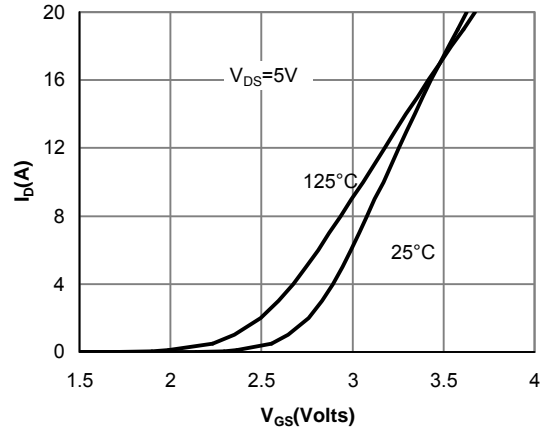

Figure 2: Transfer Characteristics

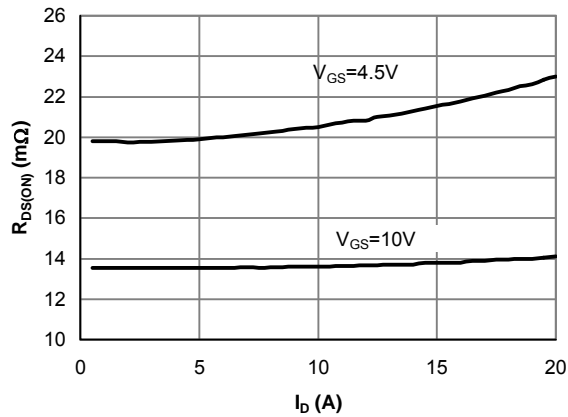

Figure 3: On-Resistance vs. Drain Current and Gate Voltage

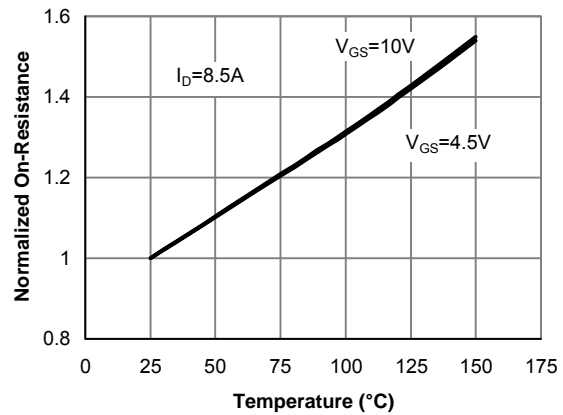

Figure 4: On-Resistance vs. Junction Temperature

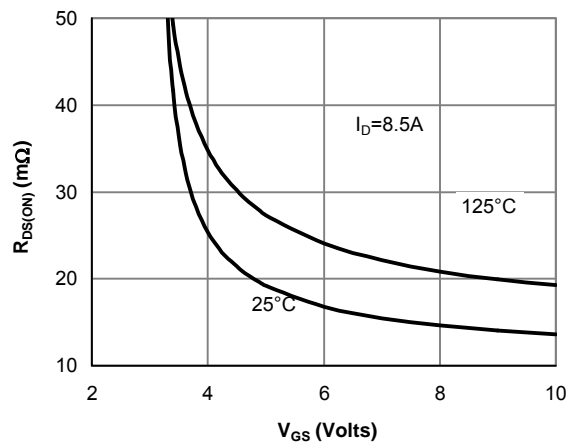

Figure 5: On-Resistance vs. Gate-Source Voltage

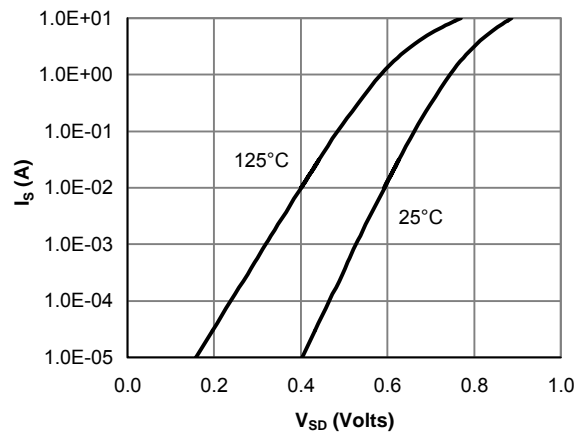

Figure 6: Body-Diode Characteristics

TYPICAL ELECTRICAL AND THERMAL CHARACTERISTICS

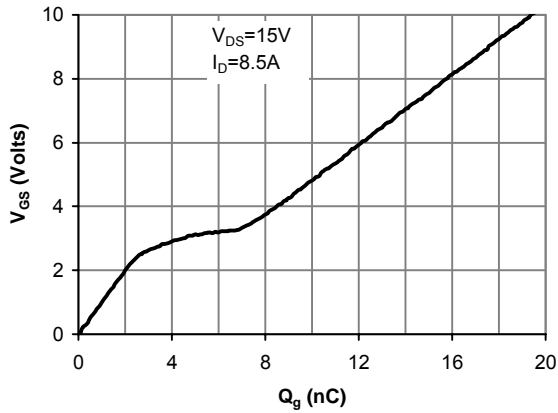

Figure 7: Gate-Charge Characteristics

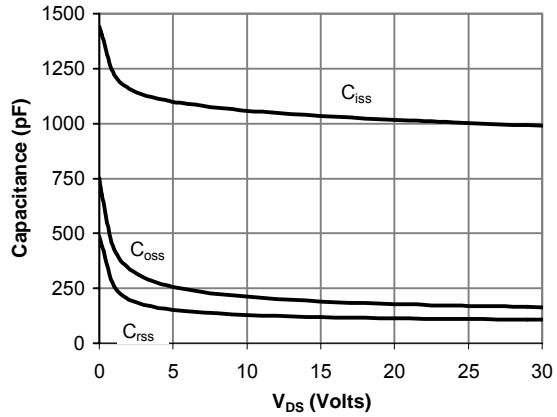

Figure 8: Capacitance Characteristics

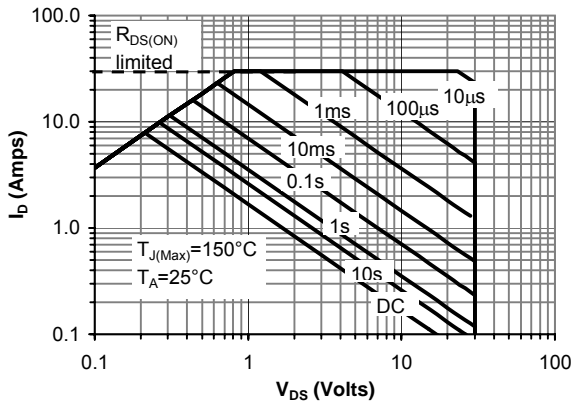

Figure 9: Maximum Forward Biased Safe Operating Area (Note E)

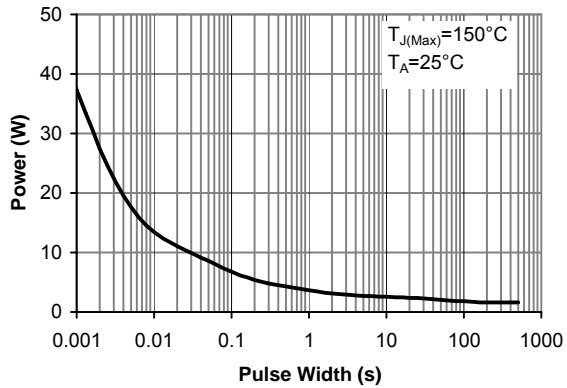

Figure 10: Single Pulse Power Rating Junction-to-Ambient (Note E)

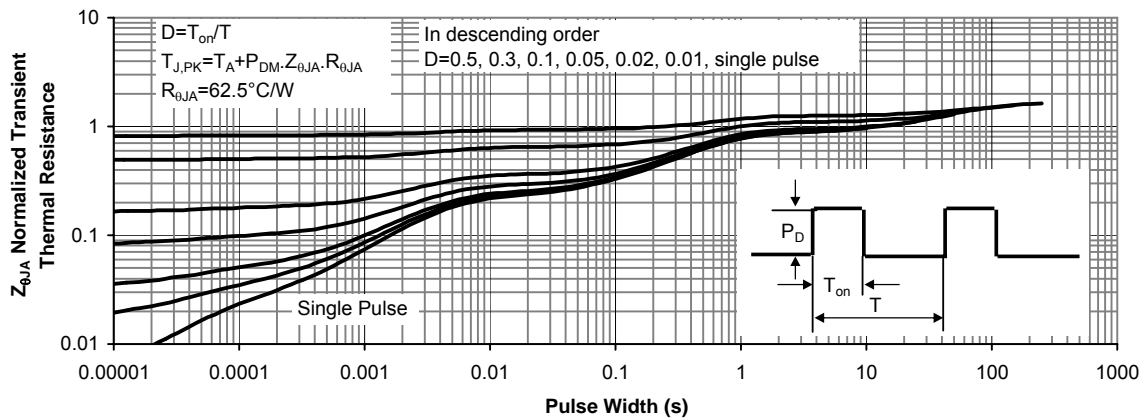

Figure 11: Normalized Maximum Transient Thermal Impedance



**ALPHA & OMEGA**  
SEMICONDUCTOR, LTD.

Document No.	PD-00071
Version	rev C
Title	AO4916 Marking Description

### SO-8 PACKAGE MARKING DESCRIPTION

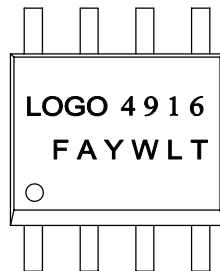

Standard product

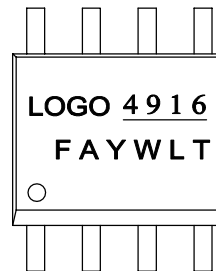

Green product

**NOTE:**

LOGO - AOS LOGO  
4916 - PART NUMBER CODE.  
F&A - FOUNDRY AND ASSEMBLY LOCATION  
Y - YEAR CODE  
W - WEEK CODE.  
L T - ASSEMBLY LOT CODE

PART NO.	DESCRIPTION	CODE
AO4916	Standard product	4916
AO4916L	Green product	<u>4916</u>



### SO-8L PACKAGE OUTLINE

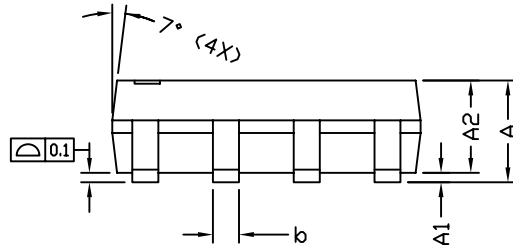
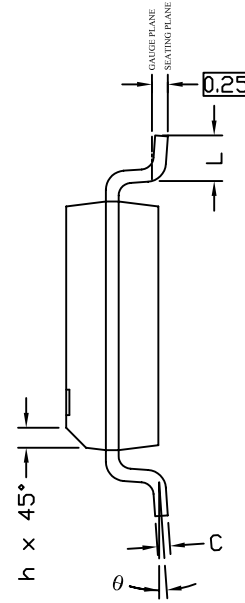
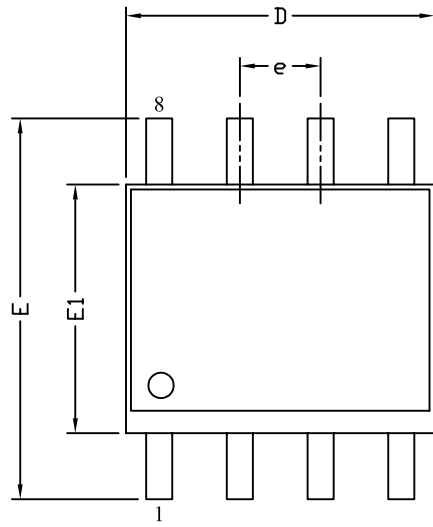

### RECOMMENDED LAND PATTERN

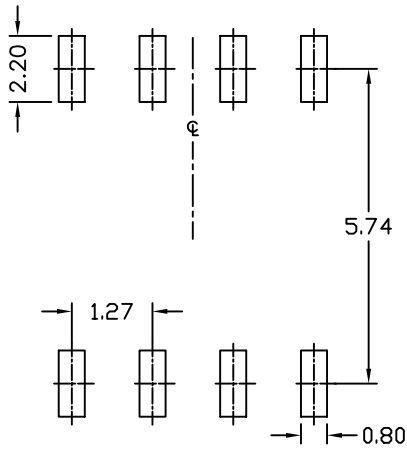

SYMBOLS	DIMENSIONS IN MILLIMETERS			DIMENSIONS IN INCHES		
	MIN	NOM	MAX	MIN	NOM	MAX
A	1.35	1.65	1.75	0.053	0.065	0.069
A1	0.10	—	0.25	0.004	—	0.010
A2	1.25	1.50	1.65	0.049	0.059	0.065
b	0.31	—	0.51	0.012	—	0.020
c	0.17	—	0.25	0.007	—	0.010
D	4.80	4.90	5.00	0.189	0.193	0.197
E1	3.80	3.90	4.00	0.150	0.154	0.157
e	1.27 BSC			0.050 BSC		
E	5.80	6.00	6.20	0.228	0.236	0.244
h	0.25	—	0.50	0.010	—	0.020
L	0.40	—	1.27	0.016	—	0.050
θ	0°	—	8°	0°	—	8°

UNIT: mm

#### NOTE

1. ALL DIMENSIONS ARE IN MILLIMETERS.
2. DIMENSIONS ARE INCLUSIVE OF PLATING.
3. PACKAGE BODY SIZES EXCLUDE MOLD FLASH AND GATE BURRS.
4. DIMENSION L IS MEASURED IN GAUGE PLANE.
5. CONTROLLING DIMENSION IS MILLIMETER. CONVERTED INCH DIMENSIONS ARE NOT NECESSARILY EXACT.



**ALPHA & OMEGA**  
SEMICONDUCTOR, LTD.

## SO-8 Tape and Reel Data

### SO-8 Carrier Tape

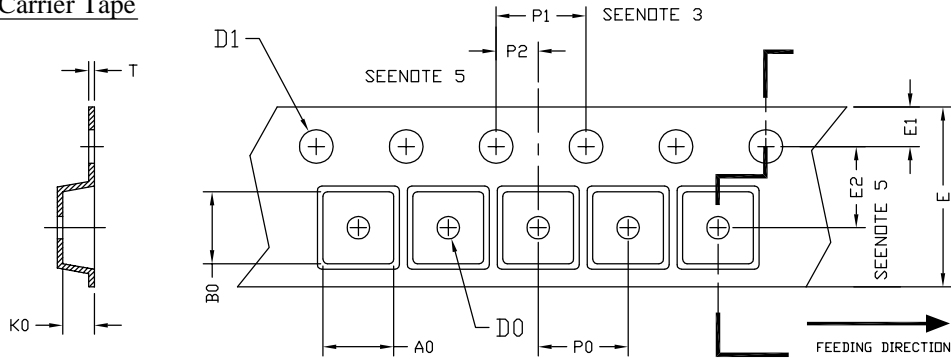

UNIT: MM

PACKAGE	A0	B0	K0	D0	D1	E	E1	E2	P0	P1	P2	T
SD-8 (12 mm)	6.40 ±0.10	5.20 ±0.10	2.10 ±0.10	1.60 ±0.10	1.50 +0.10	12.00 ±0.30	1.75 ±0.10	5.50 ±0.05	8.00 ±0.10	4.00 ±0.10	2.00 ±0.05	0.25 ±0.05

### SO-8 Reel

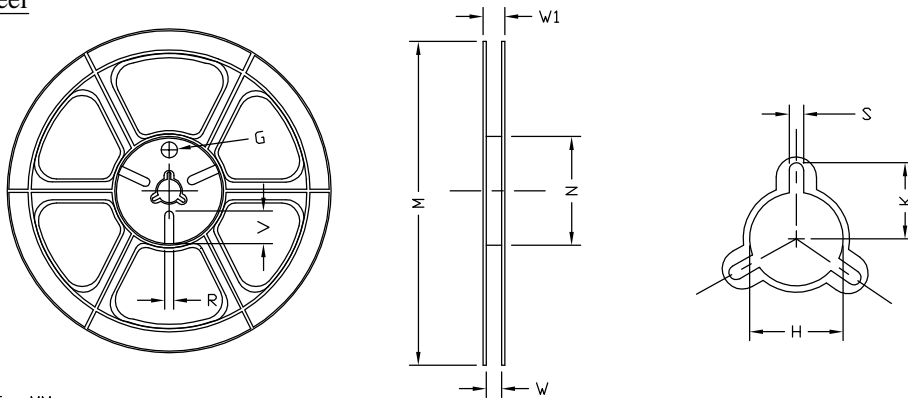

UNIT: MM

TAPE SIZE	REEL SIZE	M	N	W	W1	H	K	S	G	R	V
12 mm	ø330	ø330.00 ±0.50	ø97.00 ±0.10	13.00 ±0.30	17.40 ±1.00	ø13.00 +0.50 -0.20	10.60	2.00 ±0.50	---	---	---

### SO-8 Tape

Leader / Trailer  
& Orientation

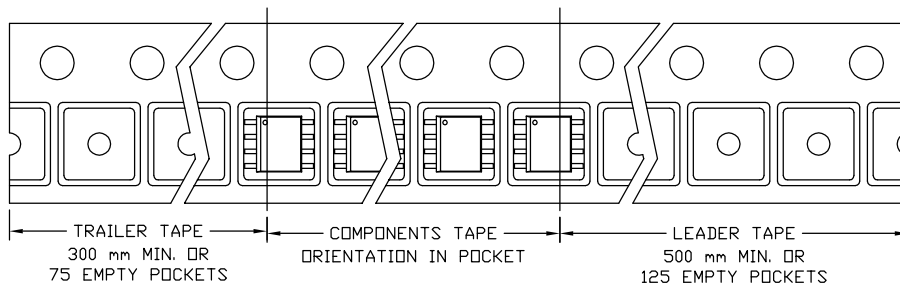

**This datasheet has been downloaded from:**

**[www.EEworld.com.cn](http://www.EEworld.com.cn)**

**Free Download**

**Daily Updated Database**

**100% Free Datasheet Search Site**

**100% Free IC Replacement Search Site**

**Convenient Electronic Dictionary**

**Fast Search System**

**[www.EEworld.com.cn](http://www.EEworld.com.cn)**