

Dual N-Channel 20-V (D-S) MOSFET

Key Features:

- Low $r_{DS(on)}$ trench technology
- Low thermal impedance
- Fast switching speed

Typical Applications:

- Battery Powered Instruments
- Portable Computing
- Mobile Phones
- GPS Units and Media Players

PRODUCT SUMMARY		
V_{DS} (V)	$r_{DS(on)}$ (m Ω)	I_D (A)
20	26 @ $V_{GS} = 4.5V$	6.8
	35 @ $V_{GS} = 2.5V$	5.8
	46 @ $V_{GS} = 1.8V$	4.7



RoHS
COMPLIANT
HALOGEN
FREE

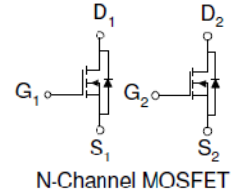
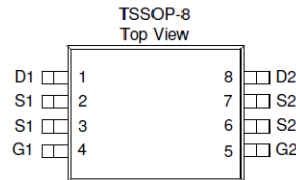

ABSOLUTE MAXIMUM RATINGS ($T_A = 25^\circ\text{C}$ UNLESS OTHERWISE NOTED)				
Parameter		Symbol	Limit	Units
Drain-Source Voltage		V_{DS}	20	V
Gate-Source Voltage		V_{GS}	± 8	
Continuous Drain Current ^a	$T_A=25^\circ\text{C}$	I_D	6.8	A
	$T_A=70^\circ\text{C}$		5.5	
Pulsed Drain Current ^b		I_{DM}	30	
Continuous Source Current (Diode Conduction) ^a		I_S	2.2	A
Power Dissipation ^a	$T_A=25^\circ\text{C}$	P_D	1.5	W
	$T_A=70^\circ\text{C}$		1	
Operating Junction and Storage Temperature Range		T_J, T_{stg}	-55 to 150	$^\circ\text{C}$

THERMAL RESISTANCE RATINGS				
Parameter		Symbol	Maximum	Units
Maximum Junction-to-Ambient ^a	$t \leq 10$ sec	$R_{\theta JA}$	83	$^\circ\text{C}/\text{W}$
	Steady State		120	

Notes

- Surface Mounted on 1" x 1" FR4 Board.
- Pulse width limited by maximum junction temperature

Electrical Characteristics

Parameter	Symbol	Test Conditions	Min	Typ	Max	Unit
Static						
Gate-Source Threshold Voltage	$V_{GS(th)}$	$V_{DS} = V_{GS}, I_D = 250 \mu A$	0.4			V
Gate-Body Leakage	I_{GSS}	$V_{DS} = 0 V, V_{GS} = \pm 8 V$			± 100	nA
Zero Gate Voltage Drain Current	I_{DSS}	$V_{DS} = 16 V, V_{GS} = 0 V$			1	μA
		$V_{DS} = 16 V, V_{GS} = 0 V, T_J = 55^\circ C$			10	
On-State Drain Current	$I_{D(on)}$	$V_{DS} = 5 V, V_{GS} = 4.5 V$	25			A
Drain-Source On-Resistance	$r_{DS(on)}$	$V_{GS} = 4.5 V, I_D = 5.0 A$			26	$m\Omega$
		$V_{GS} = 2.5 V, I_D = 4.3 A$			35	
		$V_{GS} = 1.8 V, I_D = 3.5 A$			46	
Forward Transconductance	g_{fs}	$V_{DS} = 10 V, I_D = 5.0 A$		25		S
Diode Forward Voltage	V_{SD}	$I_S = 2.2 A, V_{GS} = 0 V$		0.7		V
Dynamic						
Total Gate Charge	Q_g	$V_{DS} = 10 V, V_{GS} = 4.5 V, I_D = 5.0 A$		6.2		nC
Gate-Source Charge	Q_{gs}			1.0		
Gate-Drain Charge	Q_{gd}			1.9		
Turn-On Delay Time	$t_{d(on)}$	$V_{DD} = 10 V, R_L = 2.0 \Omega, I_D = 5.0 A,$ $V_{GEN} = 10 V, R_{GEN} = 6 \Omega$		12		ns
Rise Time	t_r			15		
Turn-Off Delay Time	$t_{d(off)}$			56		
Fall Time	t_f			17		
Input Capacitance	C_{iss}	$V_{DS} = 10 V, V_{GS} = 0 V, f = 1 MHz$		479		pF
Output Capacitance	C_{oss}			72		
Reverse Transfer Capacitance	C_{rss}			58		

Notes

- Pulse test: PW \leq 300us duty cycle \leq 2%.
- Guaranteed by design, not subject to production testing.

Analog Power (APL) reserves the right to make changes without further notice to any products herein. APL makes no warranty, representation or guarantee regarding the suitability of its products for any particular purpose, nor does APL assume any liability arising out of the application or use of any product or circuit, and specifically disclaims any and all liability, including without limitation special, consequential or incidental damages. "Typical" parameters which may be provided in APL data sheets and/or specifications can and do vary in different applications and actual performance may vary over time. All operating parameters, including "Typicals" must be validated for each customer application by customer's technical experts. APL does not convey any license under its patent rights nor the rights of others. APL products are not designed, intended, or authorized for use as components in systems intended for surgical implant into the body, or other applications intended to support or sustain life, or for any other application in which the failure of the APL product could create a situation where personal injury or death may occur. Should Buyer purchase or use APL products for any such unintended or unauthorized application, Buyer shall indemnify and hold APL and its officers, employees, subsidiaries, affiliates, and distributors harmless against all claims, costs, damages, and expenses, and reasonable attorney fees arising out of, directly or indirectly, any claim of personal injury or death associated with such unintended or unauthorized use, even if such claim alleges that APL was negligent regarding the design or manufacture of the part. APL is an Equal Opportunity/Affirmative Action Employer.

Typical Electrical Characteristics

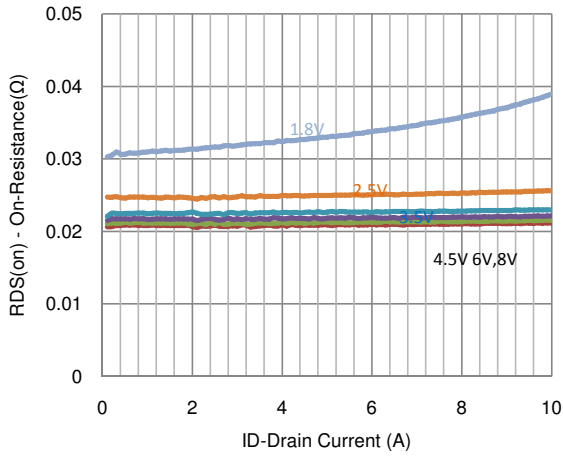

1. On-Resistance vs. Drain Current

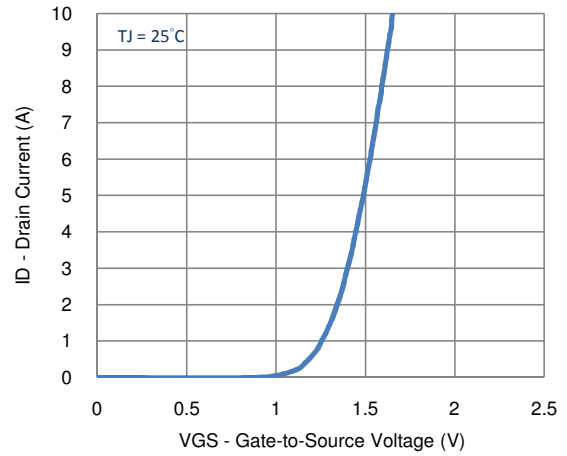

2. Transfer Characteristics

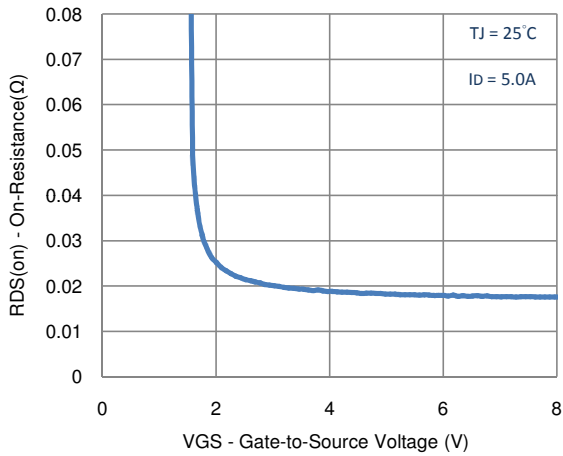

3. On-Resistance vs. Gate-to-Source Voltage

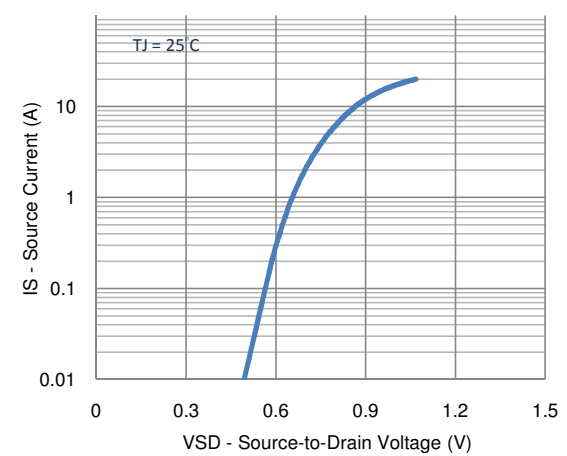

4. Drain-to-Source Forward Voltage

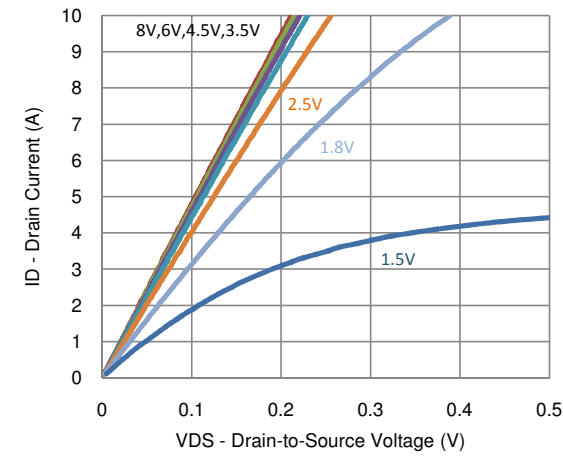

5. Output Characteristics

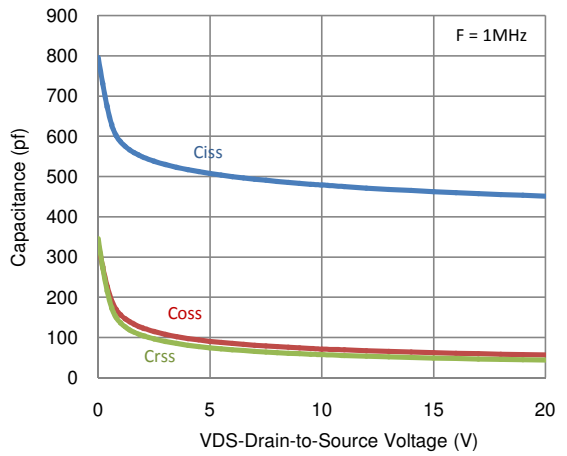

6. Capacitance

Typical Electrical Characteristics

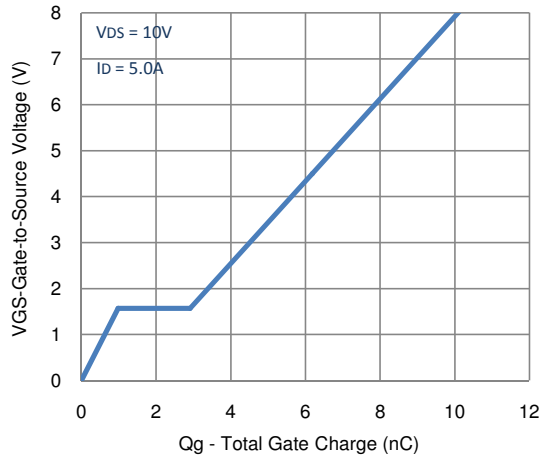

7. Gate Charge

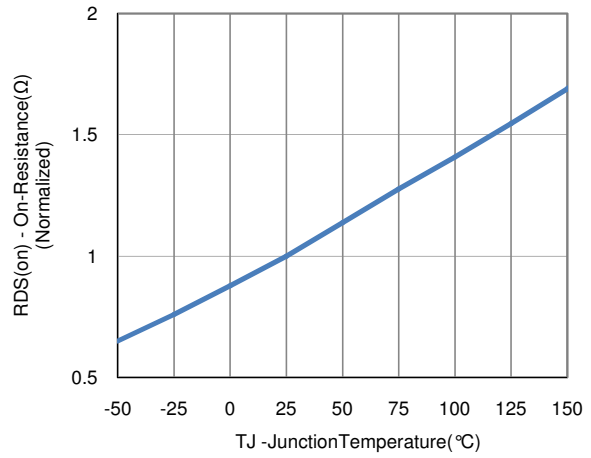

8. Normalized On-Resistance Vs Junction Temperature

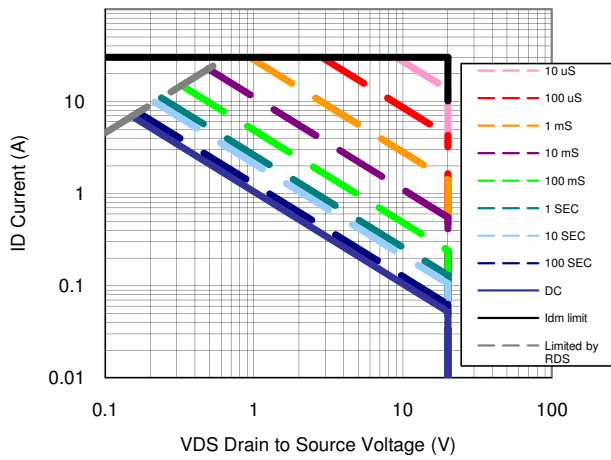

9. Safe Operating Area

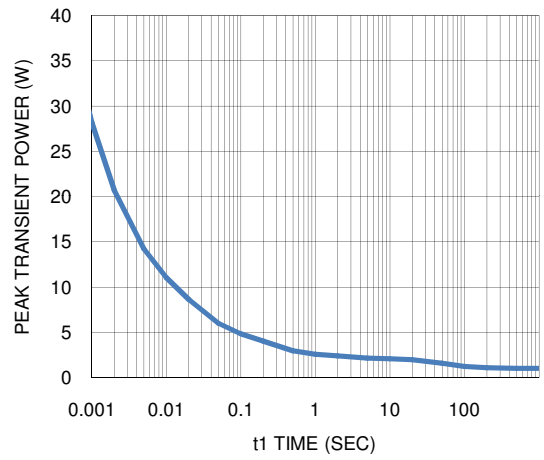

10. Single Pulse Maximum Power Dissipation

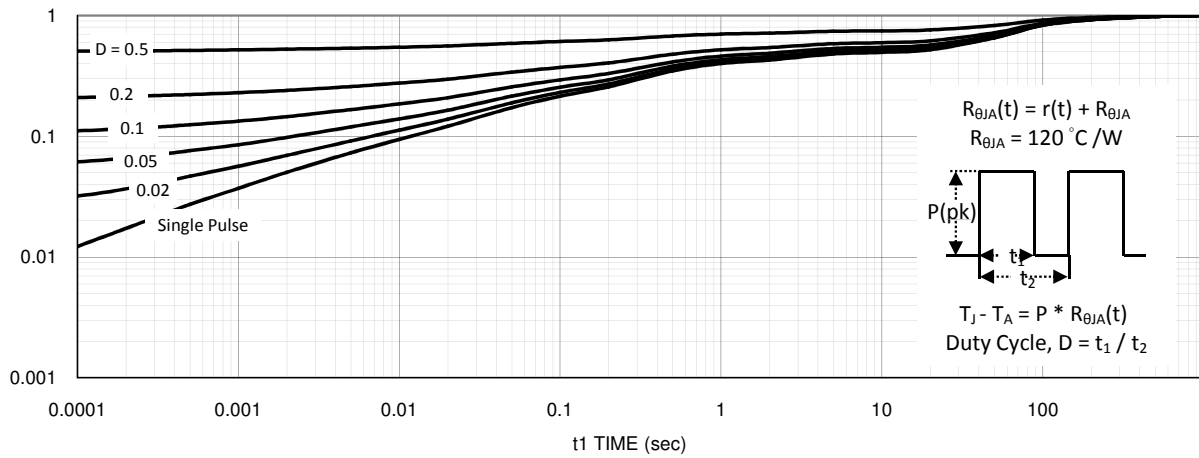

11. Normalized Thermal Transient Junction to Ambient

Package Information

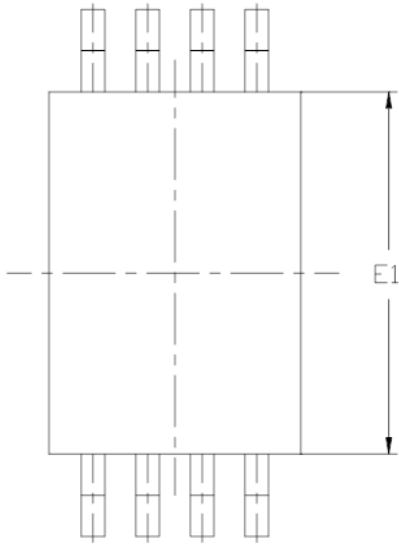

DIM.	MILLIMETERS		
	MIN.	NOM.	MAX.
A	1.05	1.10	1.20
A(1)	0.05	0.10	0.15
A(2)	0.99	1.02	1.05
B	0.19	0.25	0.30
C	--	0.127	--
D	2.90	3.00	3.10
E	6.20	6.40	6.60
E1	4.30	4.40	4.50
e	0.65BSC		
L	0.45	0.60	0.75
L1	0.90	1.00	1.10
Y	--	--	0.10
$\theta 1$	0°	4°	8°
R	0.09	--	--
S	0.20	--	--

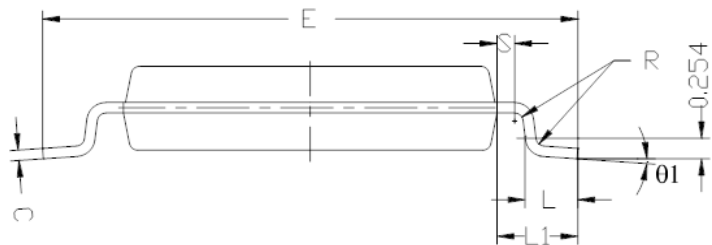
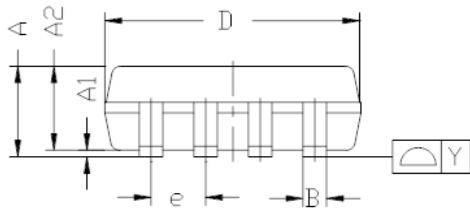

Note:

1. All Dimension Are In mm.
2. Package Body Sizes Exclude Mold Flash, Protrusion Or Gate Burrs. Mold Flash, Protrusion Or Gate Burrs Shall Not Exceed 0.10 mm Per Side.
3. Package Body Sizes Determined At The Outermost Extremes Of The Plastic Body Exclusive Of Mold Flash, Tie Bar Burrs, Gate Burrs And Interlead Flash, But Including Any Mismatch Between The Top And Bottom Of The Plastic Body.
4. The Package Top May Be Smaller Than The Package Bottom.
5. Dimension "B" Does Not Include Dambar Protrusion. Allowable Dambar Protrusion Shall Be 0.08 mm Total In Excess Of "B" Dimension At Maximum Material Condition. The Dambar Cannot Be Located On The Lower Radius Of The Foot.