

N & P-Channel 30-V (D-S) MOSFET

Key Features:

- Low $r_{DS(on)}$ trench technology
- Low thermal impedance
- Fast switching speed

Typical Applications:

- DC/DC Conversion
- Power Routing
- Motor Drives

PRODUCT SUMMARY		
V_{DS} (V)	$r_{DS(on)}$ (m Ω)	I_D (A)
30	90 @ $V_{GS} = 10V$	1.5
	130 @ $V_{GS} = 4.5V$	1.2
-30	190 @ $V_{GS} = -10V$	1.0
	290 @ $V_{GS} = -4.5V$	0.8

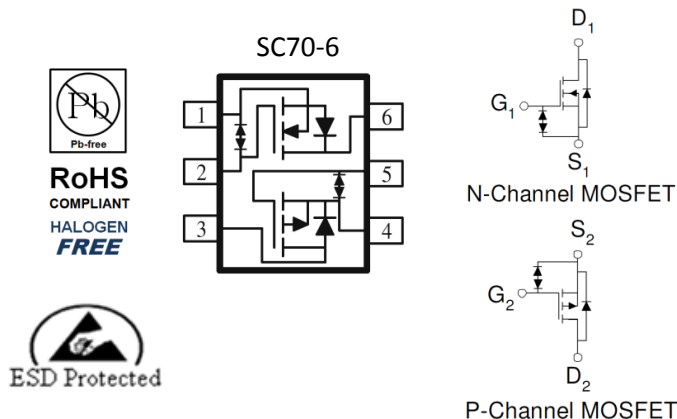

ABSOLUTE MAXIMUM RATINGS ($T_A = 25^\circ C$ UNLESS OTHERWISE NOTED)				
Parameter	Symbol	Nch Limit	Pch Limit	Units
Drain-Source Voltage	V_{DS}	30	-30	V
Gate-Source Voltage	V_{GS}	± 20	± 20	
Continuous Drain Current ^a	I_D	$T_A = 25^\circ C$	1.5	A
		$T_A = 70^\circ C$	1.25	
Pulsed Drain Current ^b	I_{DM}	10	-10	
Continuous Source Current (Diode Conduction) ^a	I_S	0.36	-0.35	A
Power Dissipation ^a	P_D	$T_A = 25^\circ C$	0.3	W
		$T_A = 70^\circ C$	0.21	
Operating Junction and Storage Temperature Range	T_J, T_{stg}	-55 to 150		$^\circ C$

THERMAL RESISTANCE RATINGS				
Parameter	Symbol	Maximum	Units	
Maximum Junction-to-Ambient ^a	$R_{\theta JA}$	t \leq 10 sec	415	$^\circ C/W$
		Steady State	460	

Notes

- a. Surface Mounted on 1" x 1" FR4 Board.
- b. Pulse width limited by maximum junction temperature

Electrical Characteristics

Parameter	Symbol	Test Conditions	Min	Typ	Max	Unit
Static						
Gate-Source Threshold Voltage	$V_{GS(th)}$	$V_{DS} = V_{GS}, I_D = 250 \mu A$ (Nch)	1			V
		$V_{DS} = V_{GS}, I_D = -250 \mu A$ (Pch)	-1			V
Gate-Body Leakage	I_{GSS}	$V_{DS} = 0 V, V_{GS} = \pm 20 V$			± 10	nA
Zero Gate Voltage Drain Current	I_{DSS}	$V_{DS} = 24 V, V_{GS} = 0 V$ (Nch)			1	μA
		$V_{DS} = -24 V, V_{GS} = 0 V$ (Pch)			-1	
On-State Drain Current ^a	$I_{D(on)}$	$V_{DS} = 5 V, V_{GS} = 10 V$ (Nch)	1.8			A
		$V_{DS} = -5 V, V_{GS} = -10 V$ (Pch)	1.2			A
Drain-Source On-Resistance ^a	$r_{DS(on)}$	$V_{GS} = 10 V, I_D = 1.1 A$ (Nch)			90	m Ω
		$V_{GS} = 4.5 V, I_D = 0.88 A$ (Nch)			130	
		$V_{GS} = -10 V, I_D = -0.8 A$ (Pch)			190	m Ω
		$V_{GS} = -4.5 V, I_D = -0.64 A$ (Pch)			290	
Forward Transconductance ^a	g_{fs}	$V_{DS} = 15 V, I_D = 1.1 A$ (Nch)		4		S
		$V_{DS} = -15 V, I_D = -0.8 A$ (Pch)		3		S
Diode Forward Voltage ^a	V_{SD}	$I_S = 0.18 A, V_{GS} = 0 V$ (Nch)		0.74		V
		$I_S = 0.175 A, V_{GS} = 0 V$ (Pch)		-0.79		V
Dynamic ^b						
Total Gate Charge	Q_g	N - Channel $V_{DS} = 15 V, V_{GS} = 4.5 V,$ $I_D = 1.2 A$		0.9		nC
Gate-Source Charge	Q_{gs}			0.32		
Gate-Drain Charge	Q_{gd}			0.30		
Turn-On Delay Time	$t_{d(on)}$	N - Channel $V_{DS} = 15 V, R_L = 12.5 \Omega,$ $I_D = 2 A,$ $V_{GEN} = 10 V, R_{GEN} = 6 \Omega$		2		ns
Rise Time	t_r			7		
Turn-Off Delay Time	$t_{d(off)}$			13		
Fall Time	t_f			4		
Input Capacitance	C_{iss}	N - Channel $V_{DS} = 15 V, V_{GS} = 0 V, f = 1 Mhz$		118		pF
Output Capacitance	C_{oss}			20		
Reverse Transfer Capacitance	C_{rss}			16		
Total Gate Charge	Q_g	P - Channel $V_{DS} = -15 V, V_{GS} = -4.5 V,$ $I_D = -0.8 A$		2.3		nC
Gate-Source Charge	Q_{gs}			0.64		
Gate-Drain Charge	Q_{gd}			0.75		
Turn-On Delay Time	$t_{d(on)}$	P - Channel $V_{DS} = -15 V, R_L = 18.7 \Omega,$ $I_D = -0.8 A,$ $V_{GEN} = -10 V, R_{GEN} = 6 \Omega$		5		ns
Rise Time	t_r			7		
Turn-Off Delay Time	$t_{d(off)}$			13		
Fall Time	t_f			5		
Input Capacitance	C_{iss}	P - Channel $V_{DS} = -15 V, V_{GS} = 0 V, f = 1 Mhz$		132		pF
Output Capacitance	C_{oss}			23		
Reverse Transfer Capacitance	C_{rss}			18		

Typical Electrical Characteristics - N-channel

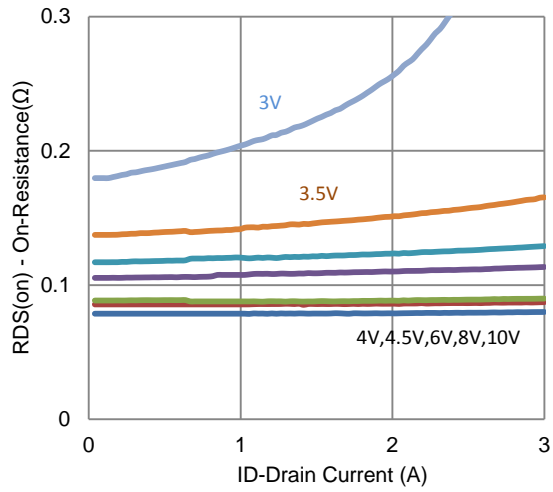

1. On-Resistance vs. Drain Current

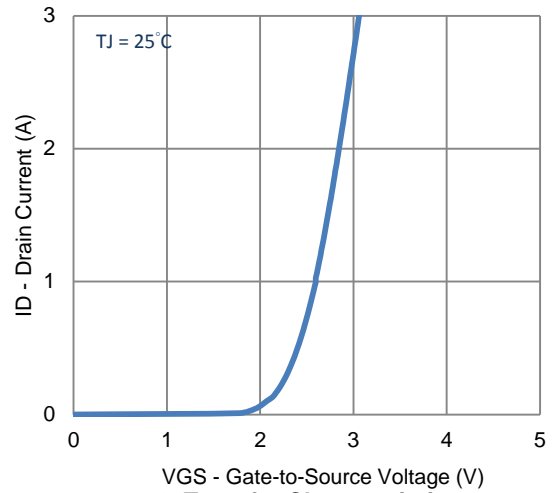

2. Transfer Characteristics

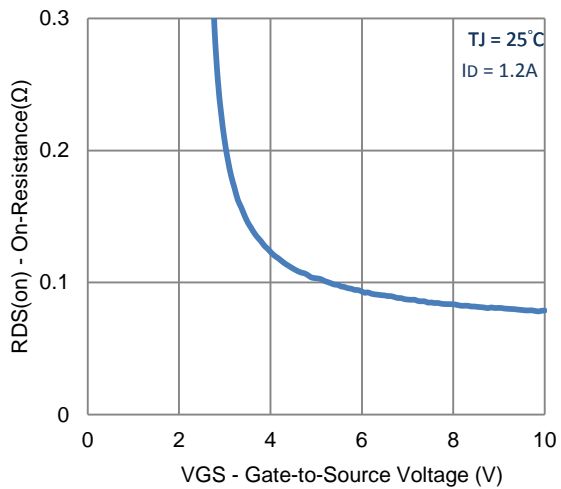

3. On-Resistance vs. Gate-to-Source Voltage

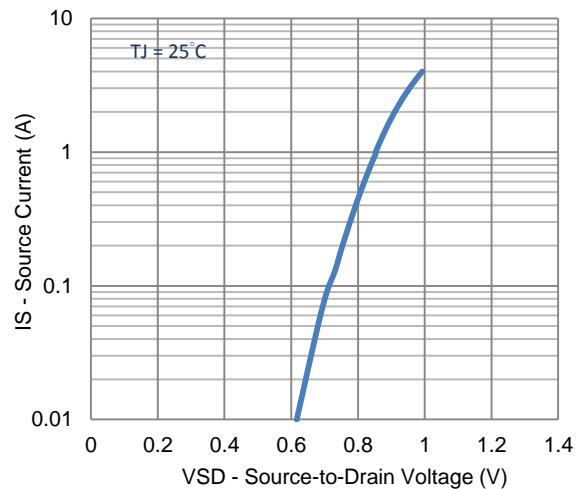

4. Drain-to-Source Forward Voltage

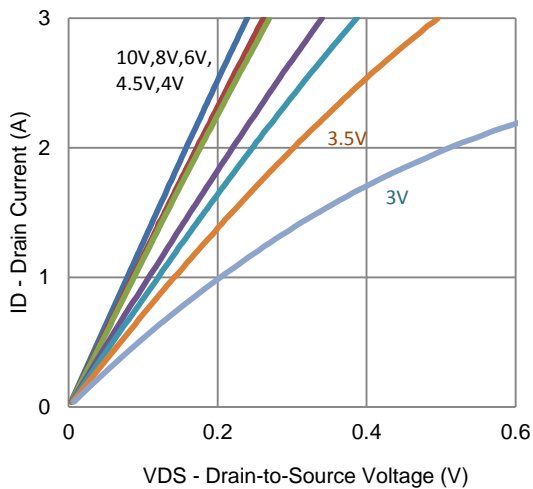

5. Output Characteristics

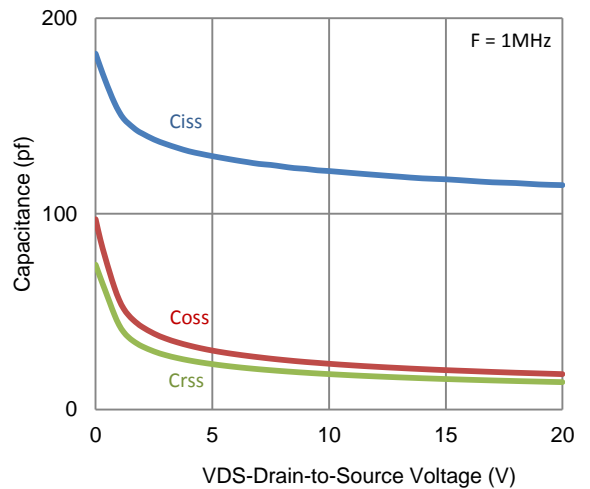

6. Capacitance

Typical Electrical Characteristics - N-channel

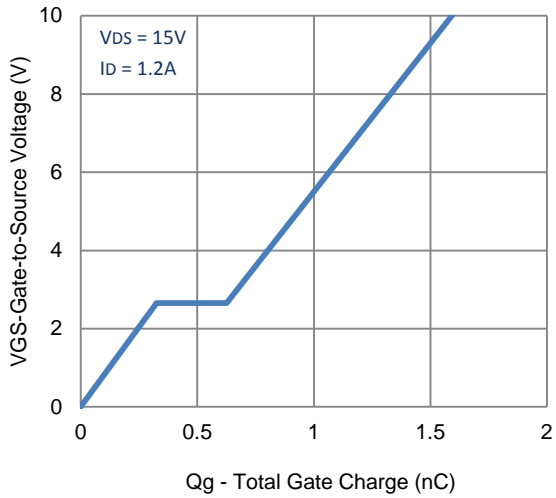

7. Gate Charge

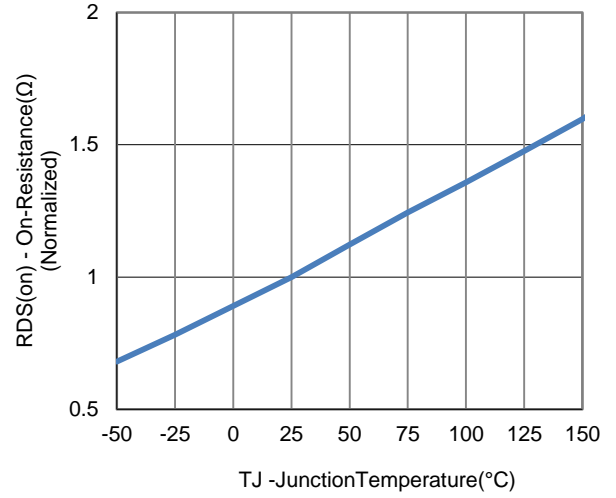

8. Normalized On-Resistance Vs Junction Temperature

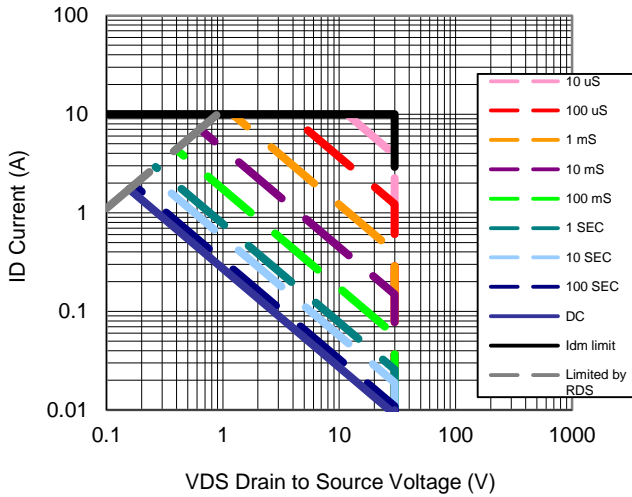

9. Safe Operating Area

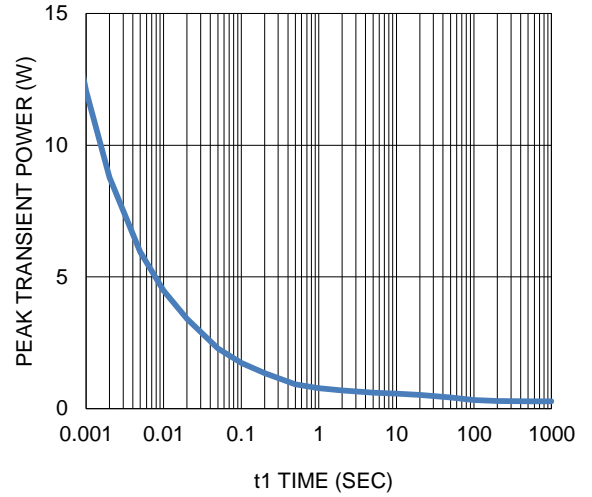

10. Single Pulse Maximum Power Dissipation

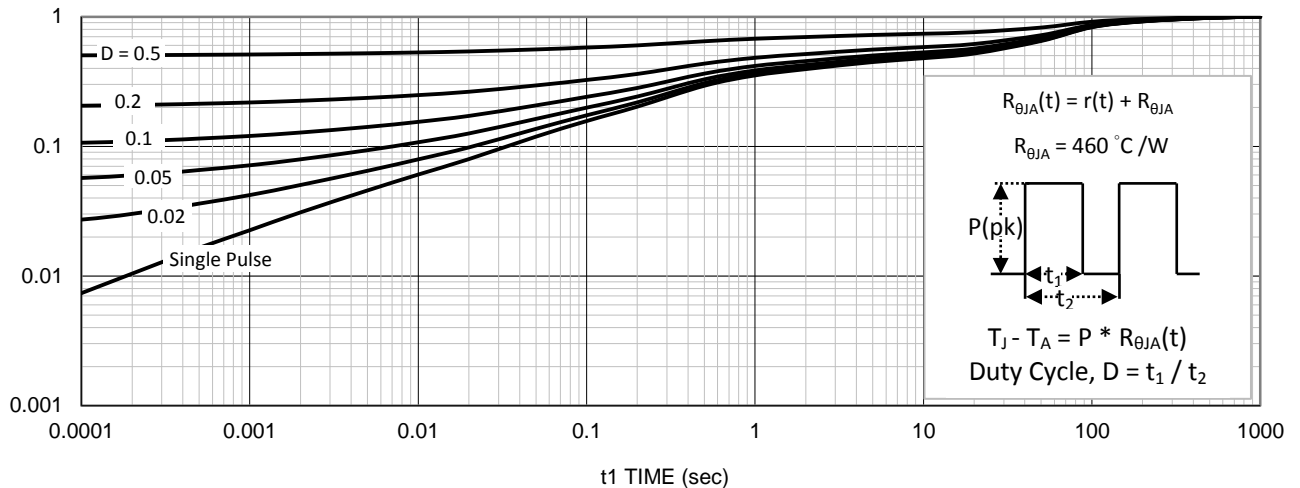

11. Normalized Thermal Transient Junction to Ambient

Typical Electrical Characteristics - P-channel

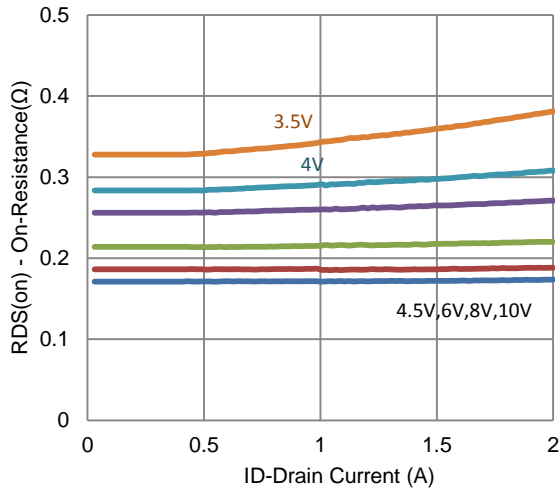

1. On-Resistance vs. Drain Current

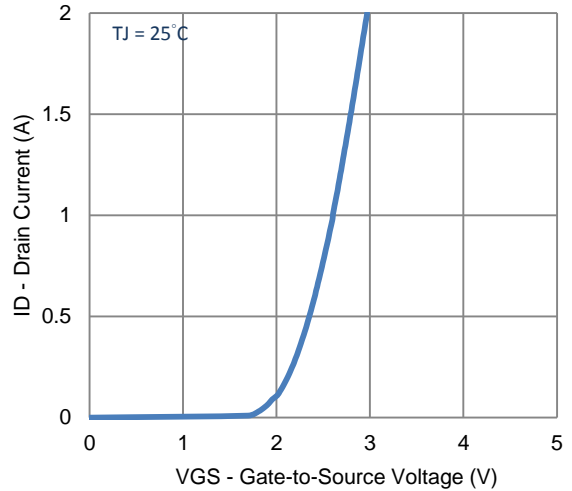

2. Transfer Characteristics

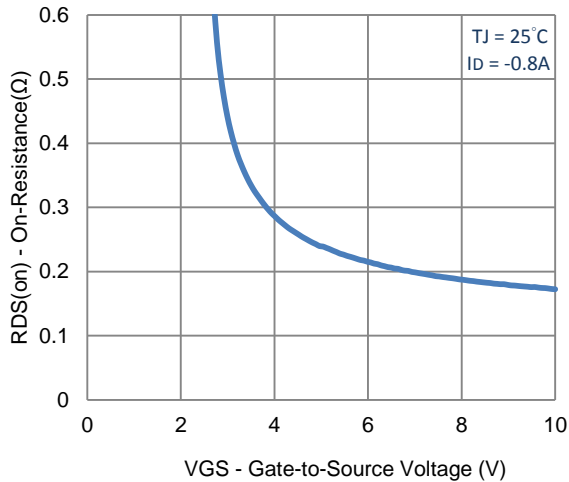

3. On-Resistance vs. Gate-to-Source Voltage

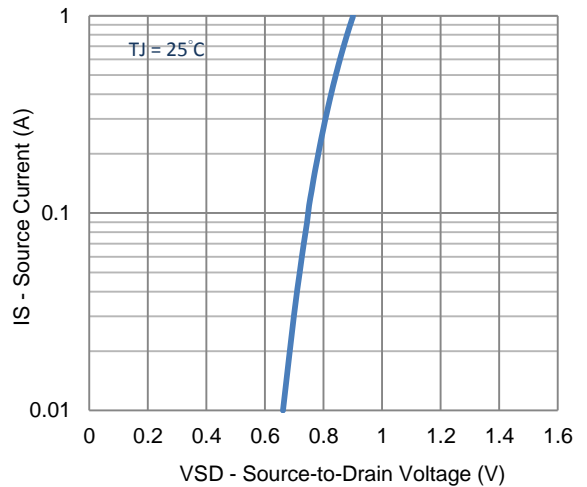

4. Drain-to-Source Forward Voltage

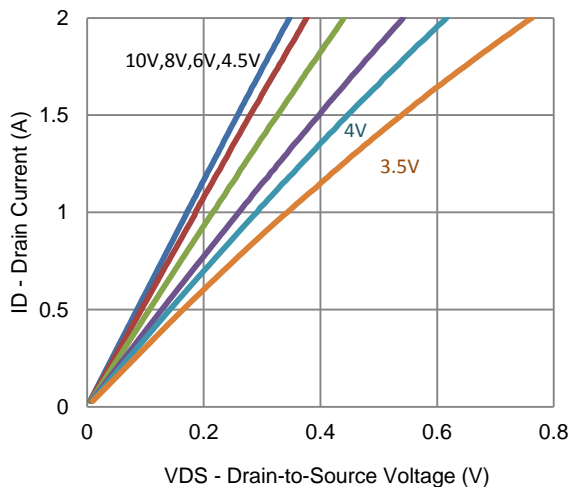

5. Output Characteristics

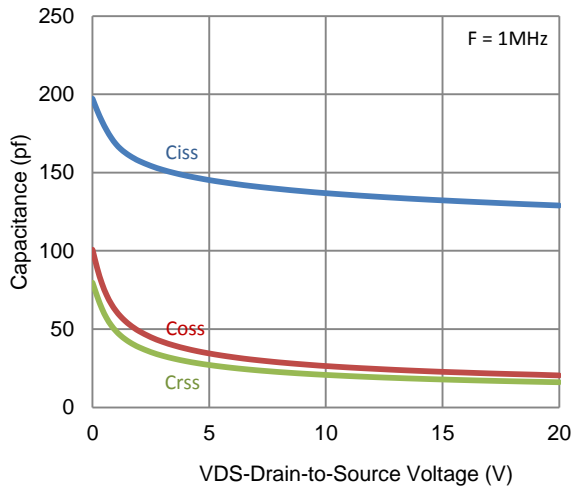

6. Capacitance

Typical Electrical Characteristics - P-channel

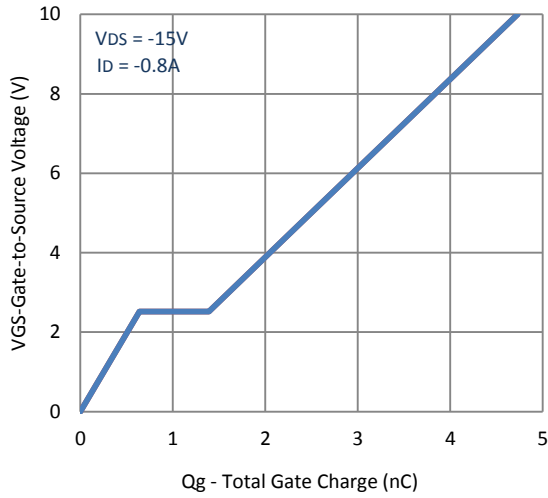

7. Gate Charge

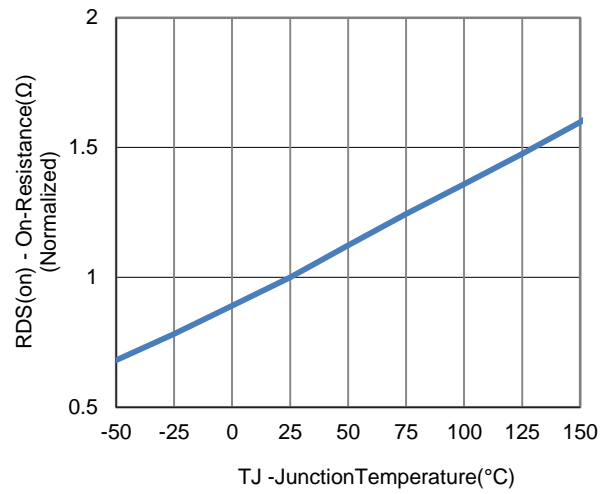

8. Normalized On-Resistance Vs Junction Temperature

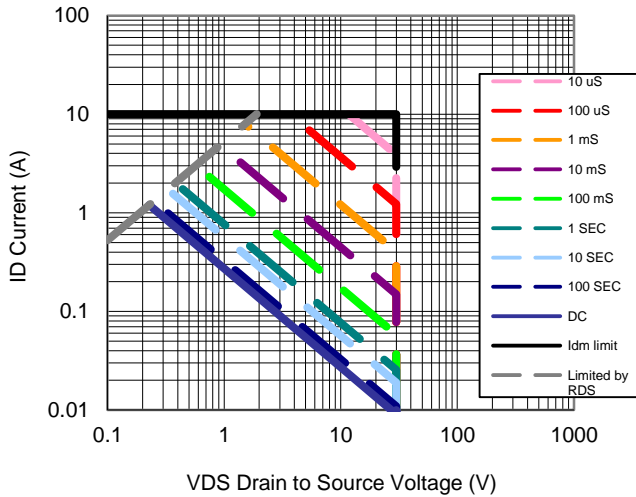

9. Safe Operating Area

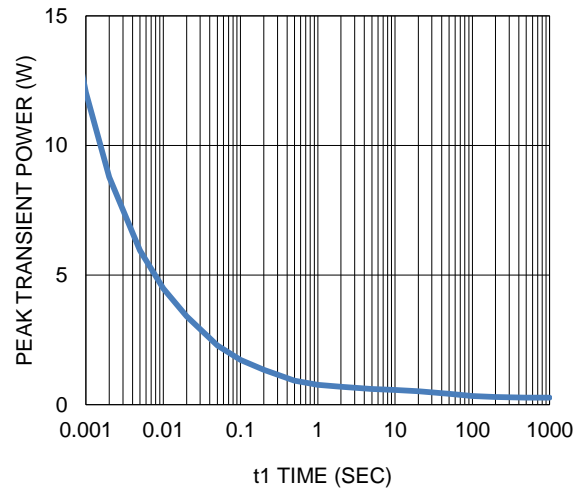

10. Single Pulse Maximum Power Dissipation

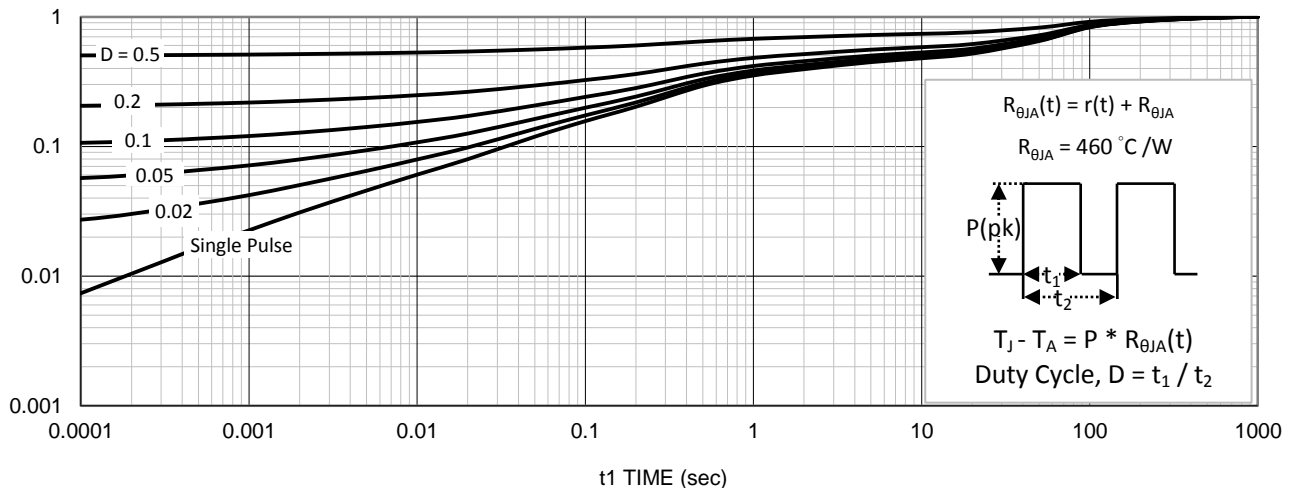

11. Normalized Thermal Transient Junction to Ambient

Package Information

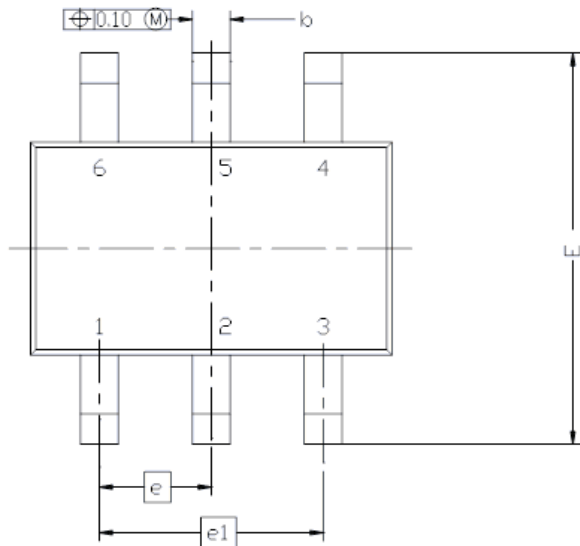

DIM.	MILLIMETERS			INCHES		
	MIN	NOM	MAX	MIN	NOM	MAX
A	0.900	0.95	1.10	0.035	0.037	0.043
A1	0.00	---	0.10	0.000	---	0.004
A2	0.70	0.90	1.00	0.028	0.035	0.039
b	0.15	0.22	0.30	0.006	0.016	0.012
c	0.08	0.127	0.20	0.003	0.005	0.008
D	2.10 BSC			0.083 BSC		
E	2.30 BSC			0.091 BSC		
E1	1.30 BSC			0.051 BSC		
e	0.65 BSC			0.026 BSC		
e1	1.30 BSC			0.051 BSC		
L	0.26	0.40	0.46	0.010	0.015	0.018
L2	0.254 BSC			0.010 BSC		
R	0.10	---	---	0.004	---	---
ϕ	0?	4?	8?	0?	4?	8?
ϑ	7?NOM			7?NOM		

