



DESCRIPTION

The AM4420 is the N-Channel logic enhancement mode power field effect transistor are produced using high cell density, This high density process is especially tailored to minimize on-state resistance.

These devices are particularly suited for low voltage application such as cellular phone and notebook computer power management and other batter powered circuits, and low in-line power loss are needed in a very small outline surface mount package.

The AM4420 is available in SOP8 Package

ORDERING INFORMATION

Package Type	Part Number	
SOP8	M8	AM4420M8R
		AM4420M8VR
Note	R: Tape & Reel V: Green Package	
AiT provides all Pb free products Suffix " V " means Green Package		

FEATURES

- 30V/13A, $R_{DS(ON)} = 8m\Omega @ V_{GS} = 10V$
- 30V/12A, $R_{DS(ON)} = 12m\Omega @ V_{GS} = 4.5V$
- Super high density cell design for extremely low $R_{DS(ON)}$
- Exceptional on-resistance and maximum DC current capability
- Available in SOP8 Package

APPLICATION

- Power Management in Note book
- Portable Equipment
- DSC
- LCD Display inverter
- Battery Powered System
- DC/DC Converter

N CHANNEL MOSFET

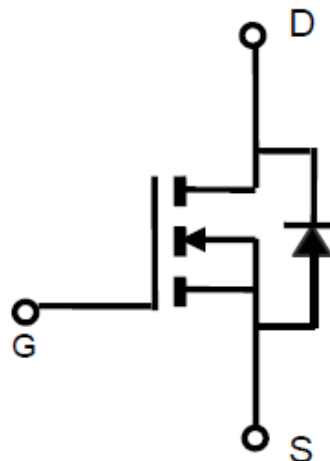



PIN DESCRIPTION

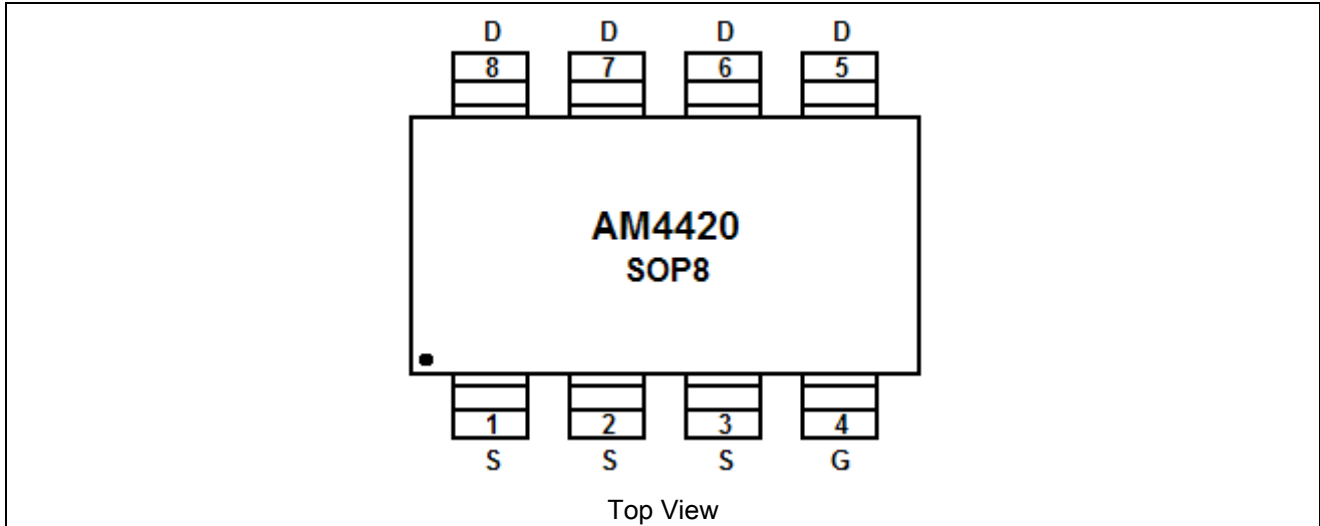

Pin #	Symbol	Function
1	S	Source
2	S	Source
3	S	Source
4	G	Gate
5	D	Drain
6	D	Drain
7	D	Drain
8	D	Drain



ABSOLUTE MAXIMUM RATINGS

T_A = 25°C Unless otherwise specified

V _{DSS} , Drain-Source Voltage		30V
V _{GSS} , Gate-Source Voltage		±20V
I _D , Continuous Drain Current (T _J =150°C)	V _{GS} =10V	13A
I _{DM} , Pulsed Drain Current		45A
I _S , Continuous Source Current (Diode Conduction)		3.5A
P _D , Power Dissipation	T _A =25°C	2.5W
	T _A =70°C	1.6W
T _J , Operation Junction Temperature		-55/150°C
T _{STG} , Storage Temperature Range		-55/150°C

Stresses above may cause permanent damage to the device. These are stress ratings only and functional operation of the device at these or any other conditions beyond those indicated in the Electrical Characteristics are not implied. Exposure to absolute maximum rating conditions for extended periods may affect device reliability.

THERMAL INFORMATION

Parameter	Symbol	Max	Unit
Thermal Resistance-Junction to Ambient	R _{θJA}	80	°C/W



ELECTRICAL CHARACTERISTICS

T_A = 25°C Unless otherwise specified

Parameter	Symbol	Conditions	Min	Typ	Max	Unit
Static Parameters						
Drain-Source Breakdown Voltage	V _{(BR)DSS}	V _{GS} =0V, I _D =250μA	30	-	-	V
Gate Threshold Voltage	V _{GS(th)}	V _{DS} =V _{GS} , I _D =250μA	1.0	-	2.5	V
Gate Leakage Current	I _{GSS}	V _{DS} =0V, V _{GS} =±20V	-	-	±100	nA
Zero Gate Voltage Drain Current	I _{DSS}	V _{DS} =24V, V _{GS} =0V	-	-	1	μA
		V _{DS} =24V, V _{GS} =0V T _J =70°C	-	-	25	
On-State Drain Current	I _{D(ON)}	V _{DS} ≥ 5V, V _{GS} =10V	25	-	-	A
Drain-source On-Resistance	R _{DS(ON)}	V _{GS} =10V, I _D =13A	-	8	10	mΩ
		V _{GS} =4.5V, I _D =12A	-	12	14	
Source-Drain Diode						
Diode Forward Voltage	V _{SD}	I _S =2.3A, V _{GS} =0V	-	0.8	1.2	V
Dynamic Parameters						
Total Gate Charge	Q _g	V _{DS} =15V	-	16	24	nC
Gate-Source Charge	Q _{GS}	V _{GS} =10V	-	4.2	-	
Gate-Drain Charge	Q _{GD}	I _D =2A	-	2.5	-	
Input Capacitance	C _{iss}	V _{DS} =15V V _{GS} =0V f=1MHz	-	1350	-	pF
Output Capacitance	C _{oss}		-	285	-	
Reverse Transfer Capacitance	C _{rss}		-	150	-	
Turn-On Time	td(on)	V _{DD} =15V	-	15	20	nS
	tr	R _L =15Ω	-	6	16	
Turn-Off Time	td(off)	I _D =5A	-	20	40	
	tf	V _{GEN} =10V R _G =1Ω	-	12	20	

NOTE: 1. Pulse test: pulse width ≤ 300us, duty cycle ≤ 2%

2. Static parameters are based on package level with recommended wire-bonding



TYPICAL CHARACTERISTICS

$T_A=25^\circ\text{C}$ Unless specified

1. Output Characteristics

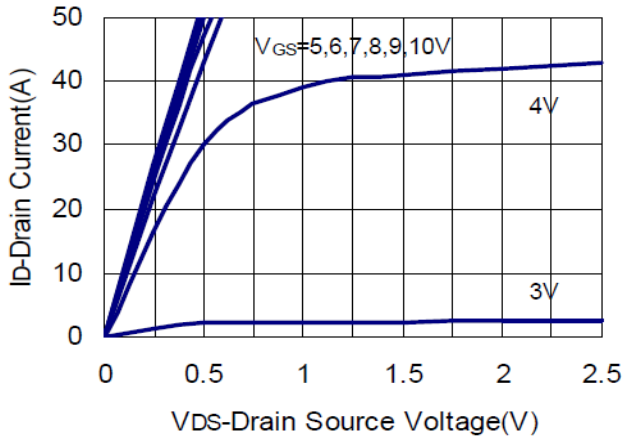

2. Transfer Characteristics

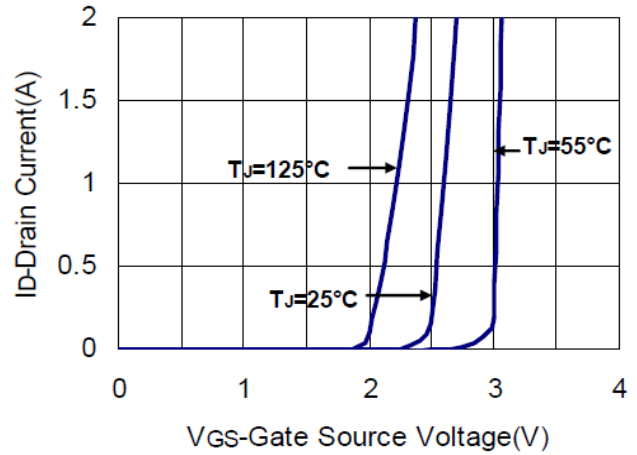

3. Drain Source On Resistance

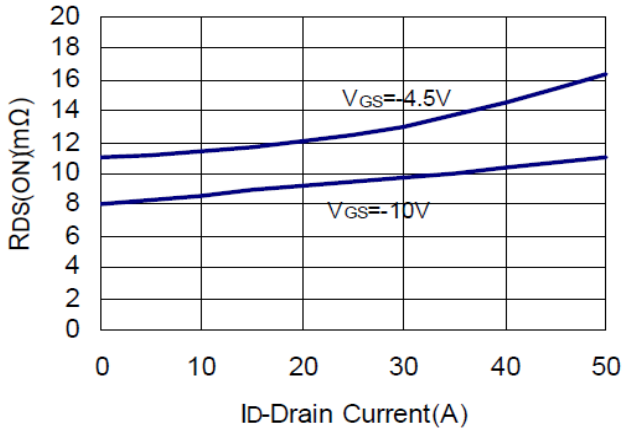

4. Gate Threshold Voltage

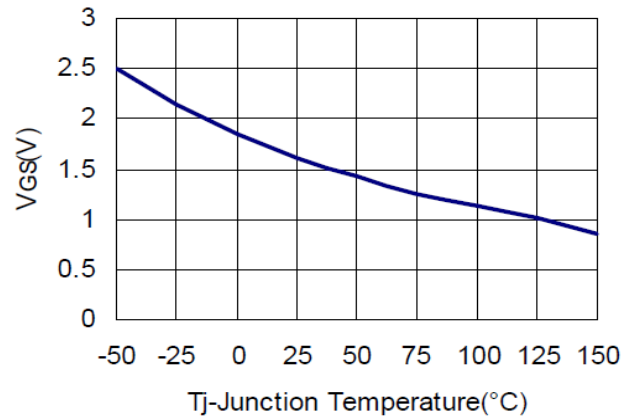

5. Gate Charge

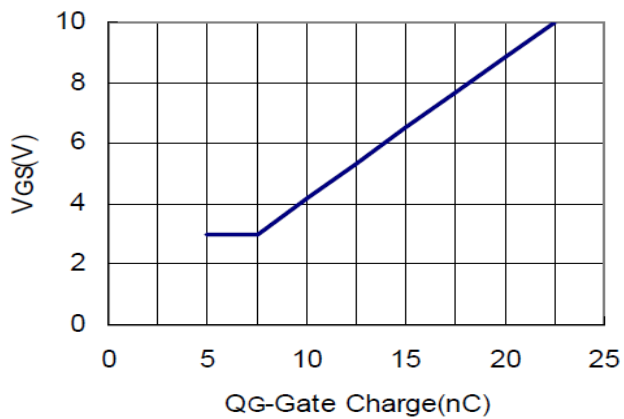

6. Drain Source On Resistance

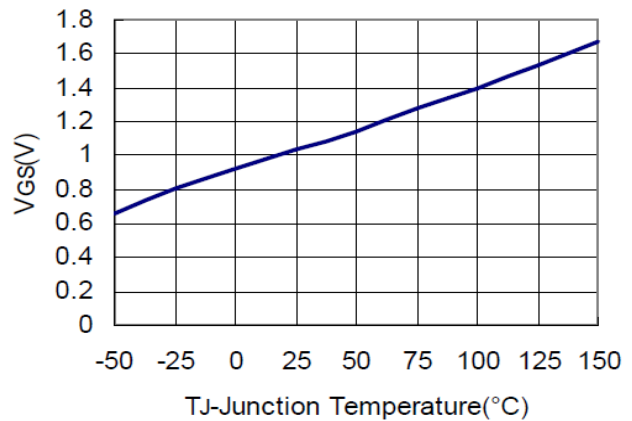



7. Source Drain Diode Forward

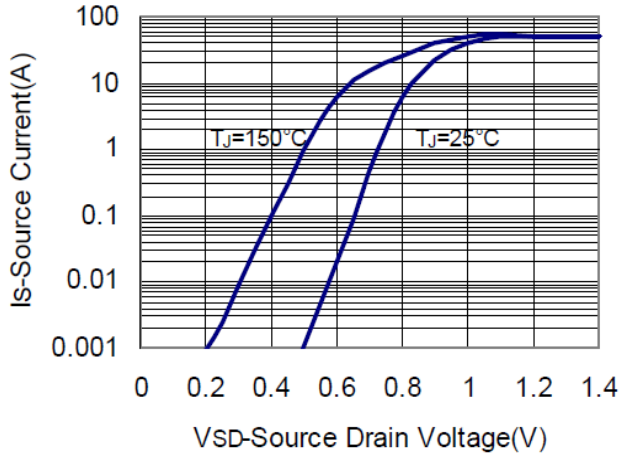

8. Capacitance

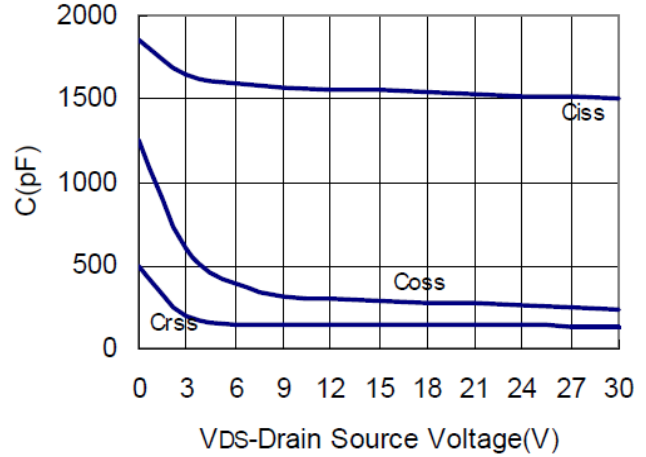

9. Power Dissipation

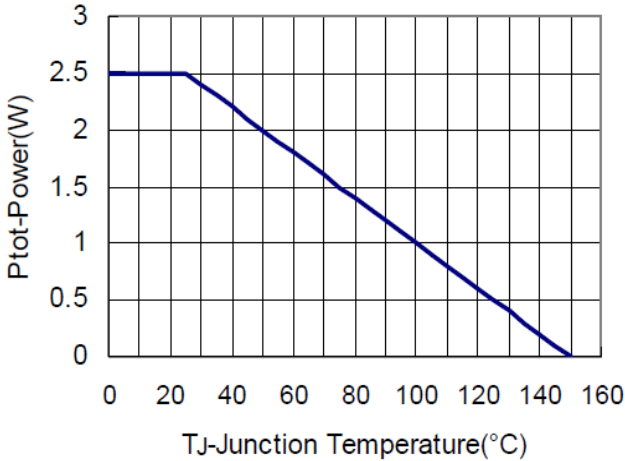

10. On Resistance VS Gate Source Voltage

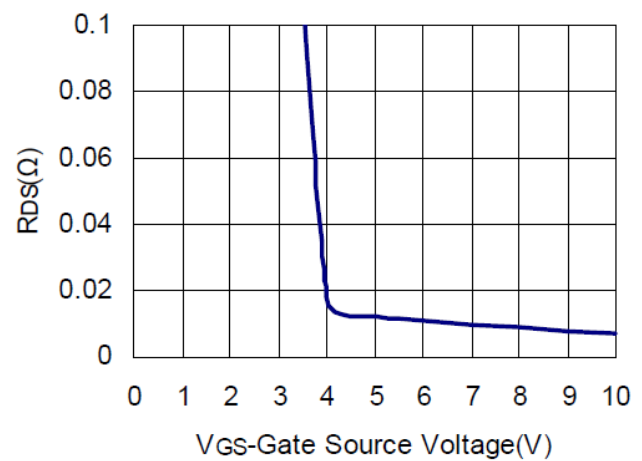

11. Thermal Transient Impedance

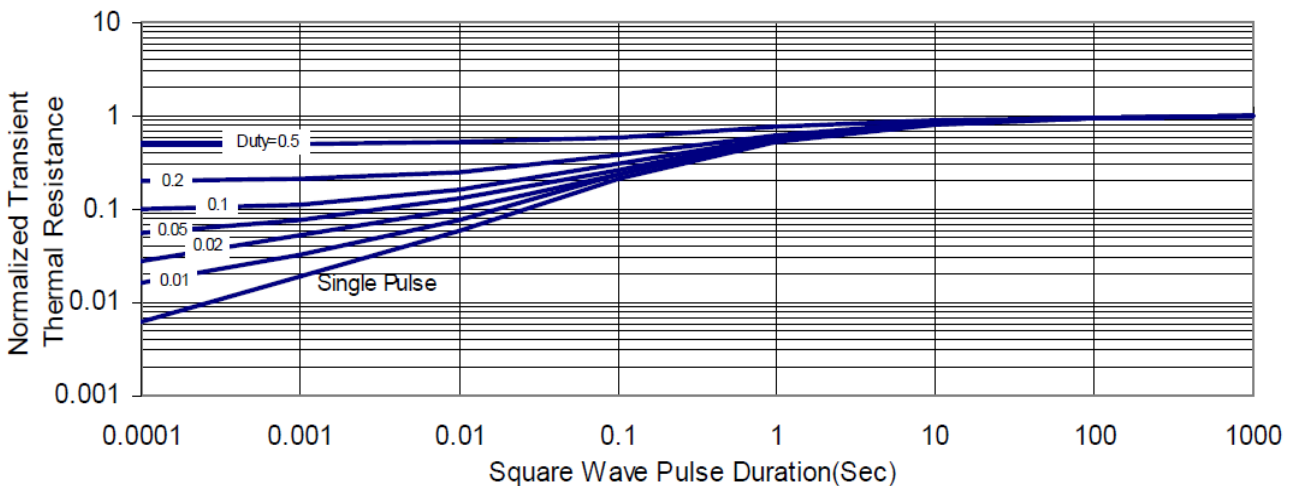



PACKAGE INFORMATION

Dimension in SOP8 Package (Unit: mm)

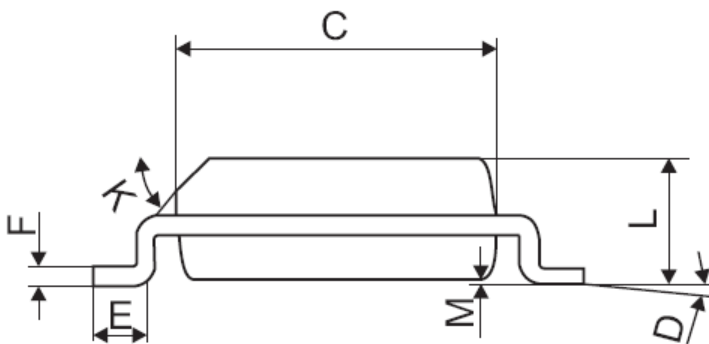
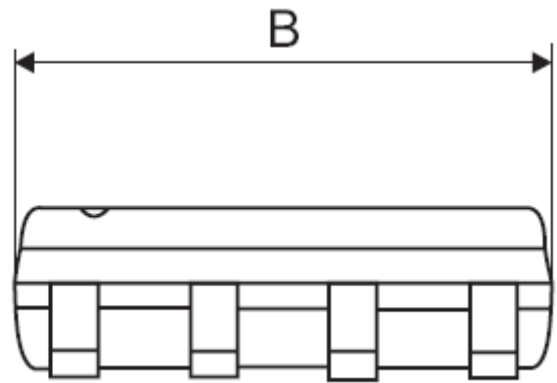
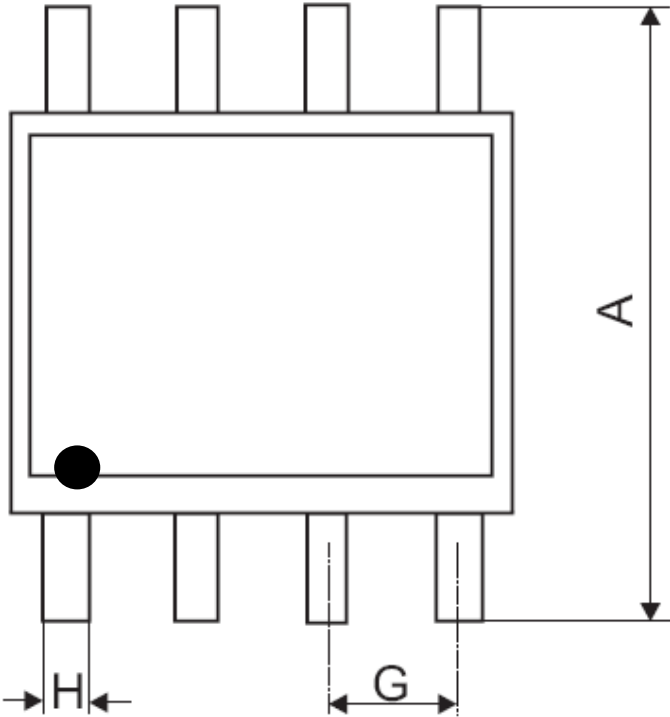

Symbol	Min	Max
A	1.40	1.75
A1	0.10	0.25
A2	1.30	1.50
B	0.33	0.51
C	0.19	0.25
D	4.80	5.30
E	3.70	4.10
e	-	-
H	5.79	6.20
L	0.38	1.27
y	-	0.10
θ	0°	8°



IMPORTANT NOTICE

AiT Semiconductor Inc. (AiT) reserves the right to make changes to any its product, specifications, to discontinue any integrated circuit product or service without notice, and advises its customers to obtain the latest version of relevant information to verify, before placing orders, that the information being relied on is current.

AiT Semiconductor Inc.'s integrated circuit products are not designed, intended, authorized, or warranted to be suitable for use in life support applications, devices or systems or other critical applications. Use of AiT products in such applications is understood to be fully at the risk of the customer. As used herein may involve potential risks of death, personal injury, or severe property, or environmental damage. In order to minimize risks associated with the customer's applications, the customer should provide adequate design and operating safeguards.

AiT Semiconductor Inc. assumes to no liability to customer product design or application support. AiT warrants the performance of its products of the specifications applicable at the time of sale.