



DESCRIPTION

The AM4407 is the P-Channel logic enhancement mode power field effect transistor is produced using high cell density. Advanced trench technology to provide excellent $R_{DS(ON)}$.

This high density process is especially tailored to minimize on-state resistance.

These devices are particularly suited for low voltage application, and low in-line power loss are needed in a very small outline surface mount package.

The AM4407 is available in SOP8 Package

FEATURES

- 30V/-12.0A, $R_{DS(ON)} = 12m\Omega(\text{typ})@V_{GS} = -10V$
- -30V/-7.5A, $R_{DS(ON)} = 19m\Omega(\text{typ})@V_{GS} = -4.5V$
- Super high density cell design for extremely low $R_{DS(ON)}$
- Exceptional on-resistance and maximum DC current capability
- Available in SOP8 Package

APPLICATION

- High Frequency Point-of-Load Synchronous
- New working DC-DC Power System
- Load Switch

ORDERING INFORMATION

| Package Type | Part Number | |
|---|------------------------------------|------------|
| SOP8 | M8 | AM4407M8R |
| | | AM4407M8VR |
| Note | R: Tape & Reel V: Green Package | |
| AiT provides all Pb free products Suffix " V " means Green Package | | |

P CHANNEL MOSFET

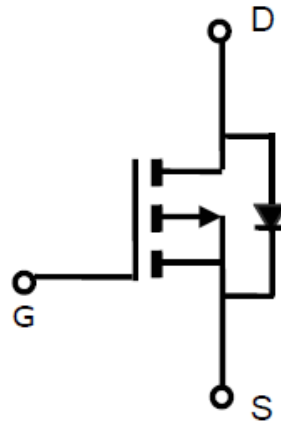



PIN DESCRIPTION

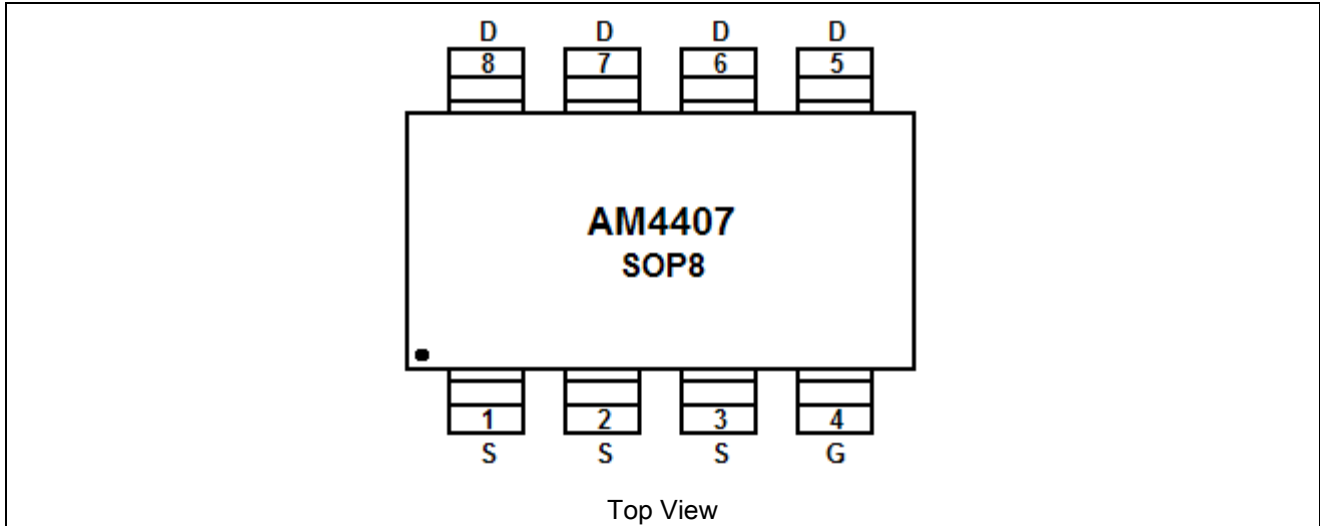

| Pin # | Symbol | Function |
|-------|--------|----------|
| 1 | S | Source |
| 2 | S | Source |
| 3 | S | Source |
| 4 | G | Gate |
| 5 | D | Drain |
| 6 | D | Drain |
| 7 | D | Drain |
| 8 | D | Drain |

THERMAL INFORMATION

| Parameter | Symbol | Max | Unit |
|--|-----------------|-----|------|
| Thermal Resistance-Junction to Ambient | $R_{\theta JA}$ | 85 | °C/W |
| Thermal Resistance-Junction to Case | $R_{\theta JC}$ | 28 | °C/W |



ABSOLUTE MAXIMUM RATINGS

T_A = 25°C Unless otherwise specified

| | | |
|--|----------------------|-----------|
| V _{DSS} , Drain-Source Voltage | | 30V |
| V _{GSS} , Gate-Source Voltage | | ±20V |
| I _D , Continuous Drain Current, V _{GS} =10V ^{NOTE1} | T _A =25°C | 12A |
| I _{DM} , Pulsed Drain Current ^{NOTE2} | | 30A |
| P _D , Power Dissipation | T _A =25°C | 3.2W |
| | T _A =70°C | 2W |
| T _J , Operation Junction Temperature | | -55/150°C |
| T _{STG} , Storage Temperature Range | | -55/150°C |

Stresses above may cause permanent damage to the device. These are stress ratings only and functional operation of the device at these or any other conditions beyond those indicated in the Electrical Characteristics are not implied. Exposure to absolute maximum rating conditions for extended periods may affect device reliability.

NOTE1: The value of R_{θJA} is measured with the device mounted on 1in 2 FR-4 board with 2oz. Copper, in a still air environment with T_A=25°C.

NOTE2: The data tested by pulsed , pulse width≤300us , duty cycle≤2%



ELECTRICAL CHARACTERISTICS

T_J = 25°C Unless otherwise specified

| Parameter | Symbol | Conditions | Min | Typ | Max | Unit |
|---------------------------------|----------------------|--|------|-------|------|------|
| Static Parameters | | | | | | |
| Drain-Source Breakdown Voltage | V _{(BR)DSS} | V _{GS} =0V, I _D =-250μA | -30 | - | - | V |
| Gate Threshold Voltage | V _{GS(th)} | V _{DS} =V _{GS} , I _D =-250μA | -1.0 | - | -2.5 | V |
| Gate Leakage Current | I _{GSS} | V _{DS} =0V, V _{GS} =±20V | - | - | ±100 | nA |
| Zero Gate Voltage Drain Current | I _{DSS} | V _{DS} =-24V, V _{GS} =0V | - | - | -1 | μA |
| | | V _{DS} =-24V, V _{GS} =0V T _J =55°C | - | - | -5 | |
| Drain-source On-Resistance | R _{DS(ON)} | V _{GS} =-10V, I _D =-12A | - | 12 | 15 | mΩ |
| | | V _{GS} =-4.5V, I _D =-7.5A | - | 19 | 25 | |
| Forward Transconductance | G _{fs} | V _{DS} =-5V, I _D =-30.0A | - | 24 | - | S |
| Source-Drain Diode | | | | | | |
| Diode Forward Voltage | V _{SD} | I _S =-2.3A, V _{GS} =0V | - | -0.75 | -1.0 | V |
| Dynamic Parameters | | | | | | |
| Total Gate Charge | Q _g | V _{DS} =-15V | - | 21 | - | nC |
| Gate-Source Charge | Q _{gs} | V _{GS} =4.5V | - | 5.2 | - | |
| Gate-Drain Charge | Q _{gd} | I _D =-12A | - | 7.5 | - | |
| Input Capacitance | C _{iss} | V _{DS} =-15V V _{GS} =0V f=1MHz | - | 2220 | - | pF |
| Output Capacitance | C _{oss} | | - | 320 | - | |
| Reverse Transfer Capacitance | C _{rss} | | - | 235 | - | |
| Turn-On Time | t _{d(on)} | V _{DD} =15V V _{GS} =-10V I _D =-5A, R _G =3.3Ω | - | 34 | - | nS |
| | t _r | | - | 35 | - | |
| Turn-Off Time | t _{d(off)} | | - | 70 | - | |
| | t _f | | - | 12 | - | |



TYPICAL CHARACTERISTICS

$T_A=25^\circ\text{C}$ Unless specified

1. Output Characteristics

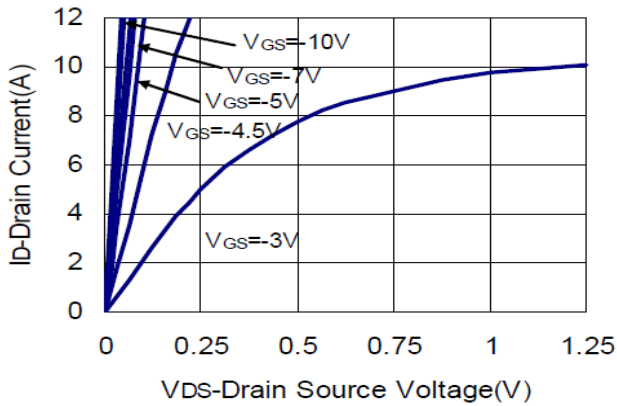

2. Drain-Source On Resistance

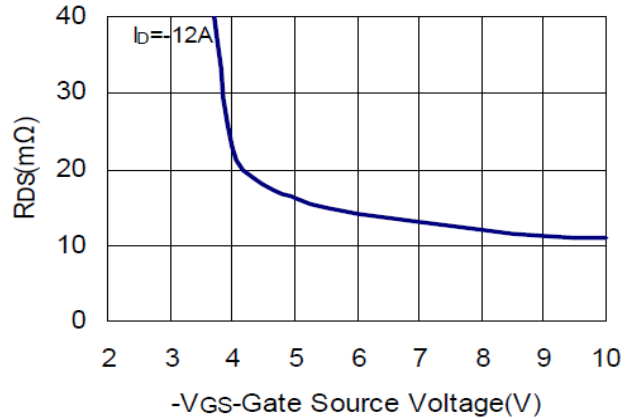

3. Drain Source On Resistance

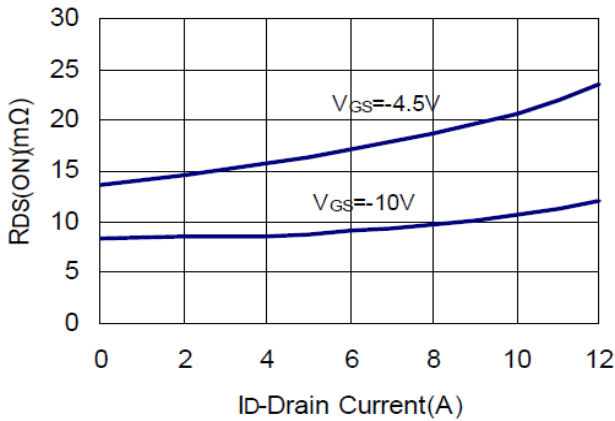

4. Transfer Characteristics

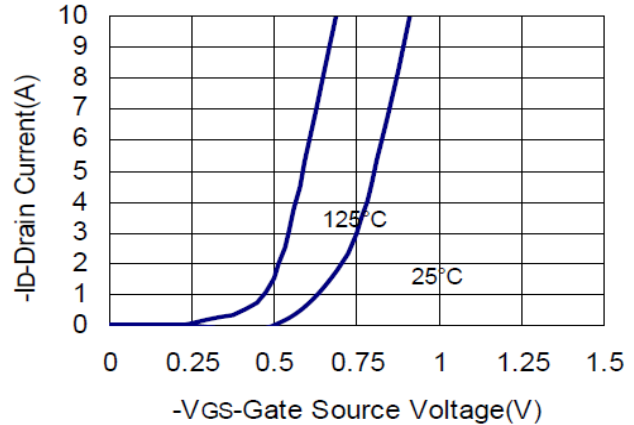

5. Gate Charge

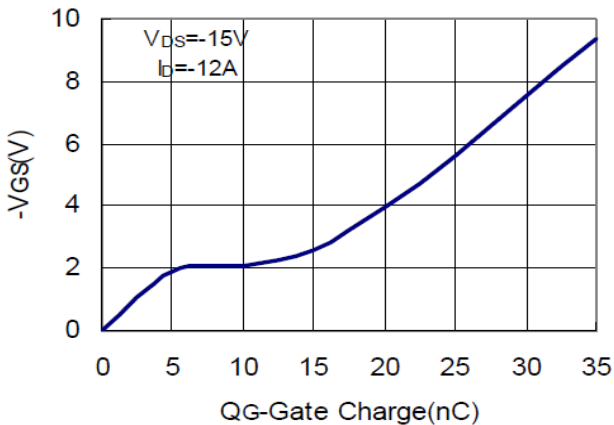

6. Drain Source Resistance

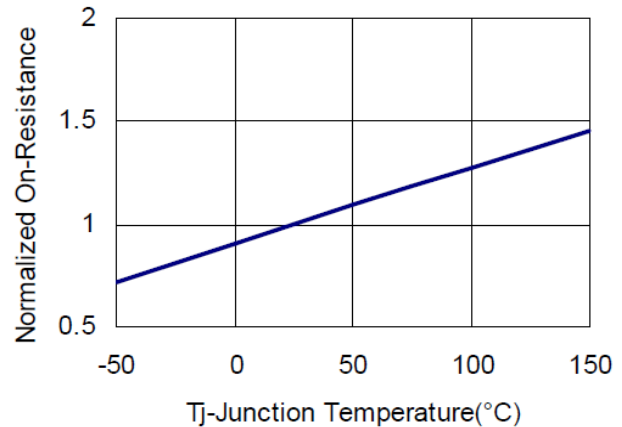



7. Source Drain Diode Forward

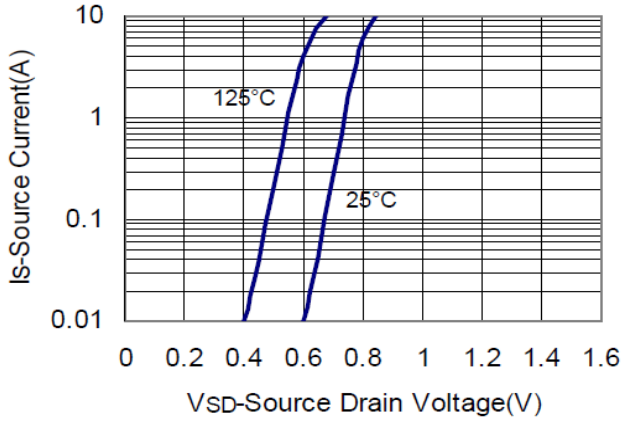

8. Capacitance

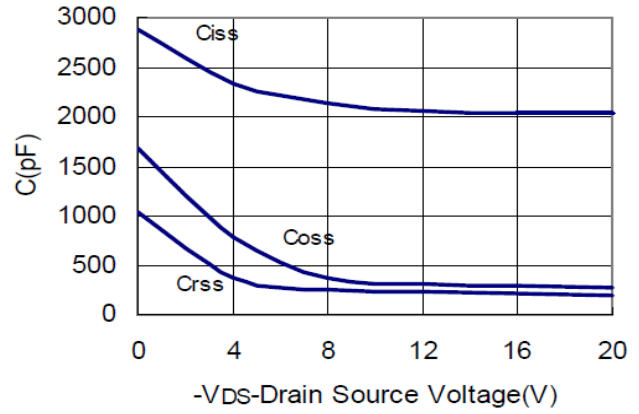

9. Power Dissipation

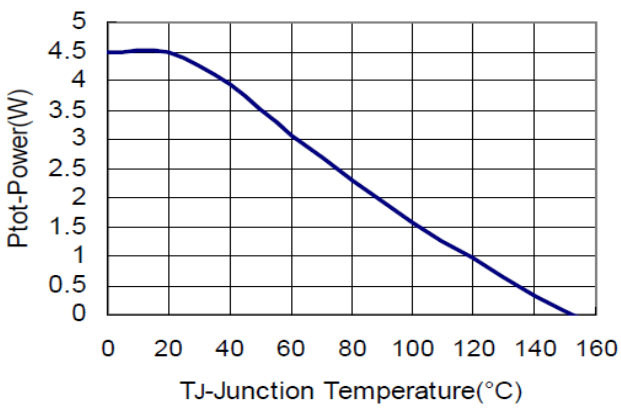

10. Drain Current

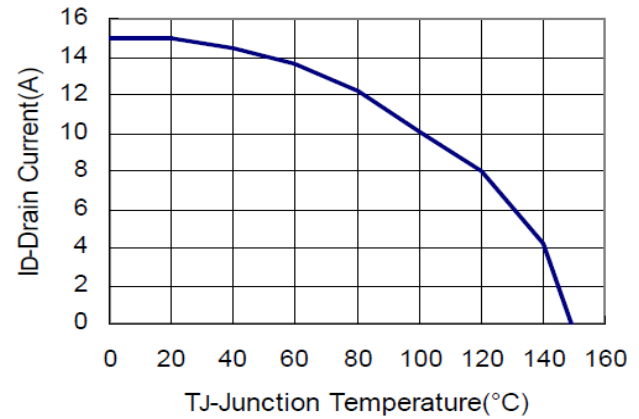

11. Thermal Transient Impedance

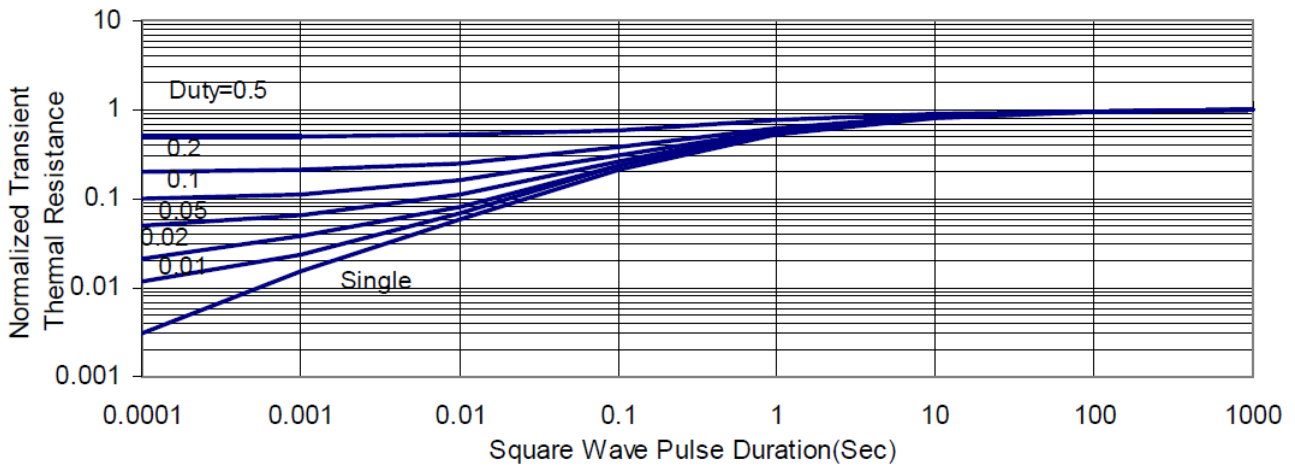



PACKAGE INFORMATION

Dimension in SOP8 (Unit: mm)

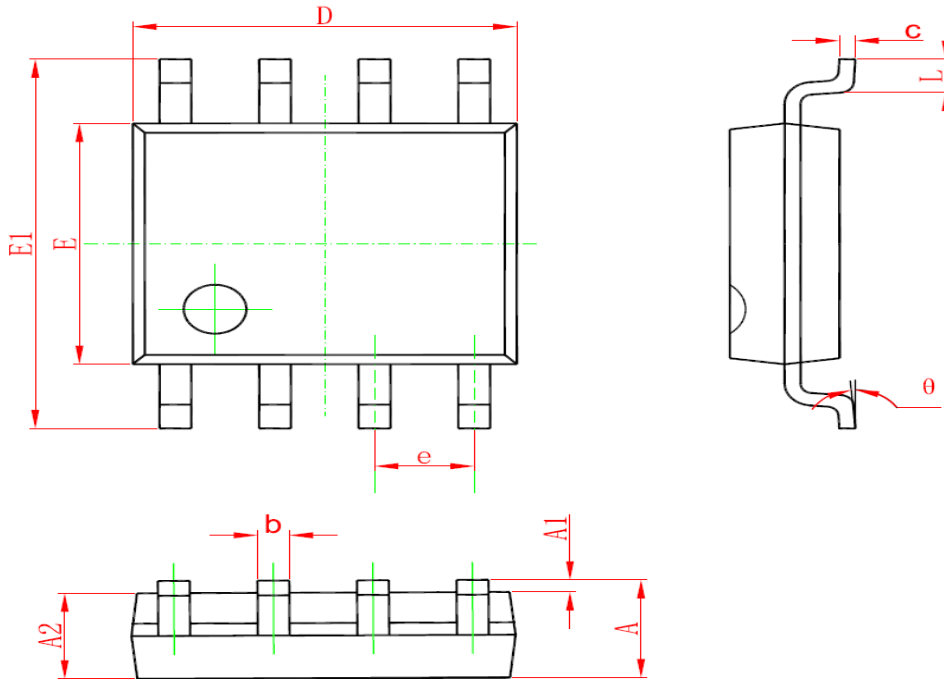

| Symbol | Min | Max |
|----------|------------|-------|
| A | 1.350 | 1.750 |
| A1 | 0.100 | 0.250 |
| A2 | 1.350 | 1.550 |
| b | 0.330 | 0.510 |
| c | 0.170 | 0.250 |
| D | 4.700 | 5.100 |
| E | 3.800 | 4.000 |
| E1 | 5.800 | 6.200 |
| e | 1.270(BSC) | |
| L | 0.400 | 1.270 |
| θ | 0° | 8° |



IMPORTANT NOTICE

AiT Semiconductor Inc. (AiT) reserves the right to make changes to any its product, specifications, to discontinue any integrated circuit product or service without notice, and advises its customers to obtain the latest version of relevant information to verify, before placing orders, that the information being relied on is current.

AiT Semiconductor Inc.'s integrated circuit products are not designed, intended, authorized, or warranted to be suitable for use in life support applications, devices or systems or other critical applications. Use of AiT products in such applications is understood to be fully at the risk of the customer. As used herein may involve potential risks of death, personal injury, or severe property, or environmental damage. In order to minimize risks associated with the customer's applications, the customer should provide adequate design and operating safeguards.

AiT Semiconductor Inc. assumes to no liability to customer product design or application support. AiT warrants the performance of its products of the specifications applicable at the time of sale.