

> Features

- High Speed Switching
- Low On-Resistance
- No Secondary Breakdown
- Low Driving Power
- High Voltage
- $V_{GS} = \pm 30V$ Guarantee
- Avalanche Proof

> Applications

- Switching Regulators
- UPS
- DC-DC converters
- General Purpose Power Amplifier

> Outline Drawing

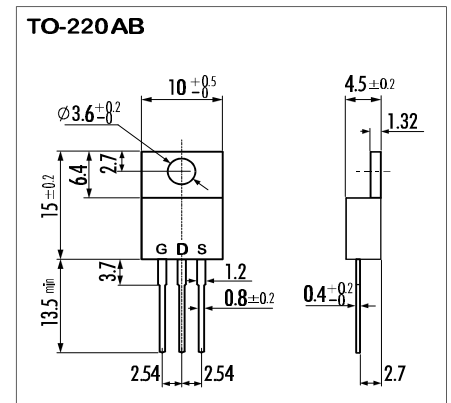

> Maximum Ratings and Characteristics

- Absolute Maximum Ratings ($T_C=25^\circ C$), unless otherwise specified

Item	Symbol	Rating	Unit
Drain-Source-Voltage	V_{DS}	200	V
Drain-Gate-Voltage ($R_{GS}=20K\Omega$)	V_{DGR}	200	V
Continous Drain Current	I_D	10	A
Pulsed Drain Current	$I_{D(puls)}$	40	A
Gate-Source-Voltage	V_{GS}	± 30	V
Max. Power Dissipation	P_D	40	W
Operating and Storage Temperature Range	T_{ch}	150	$^\circ C$
	T_{stg}	-55 ~ +150	$^\circ C$

> Equivalent Circuit

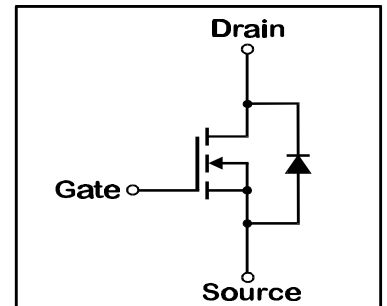

- Electrical Characteristics ($T_C=25^\circ C$), unless otherwise specified

Item	Symbol	Test conditions	Min.	Typ.	Max.	Unit
Drain-Source Breakdown-Voltage	$V_{(BR)DSS}$	$I_D=1mA$ $V_{GS}=0V$	200			V
Gate Threshold Voltage	$V_{GS(th)}$	$I_D=1mA$ $V_{DS}=V_{GS}$	2,5	3,0	3,5	V
Zero Gate Voltage Drain Current	I_{DSS}	$V_{DS}=200V$ $T_{ch}=25^\circ C$		10	500	μA
		$V_{GS}=0V$ $T_{ch}=125^\circ C$		0,2	1,0	mA
Gate Source Leakage Current	I_{GSS}	$V_{GS}=\pm 30V$ $V_{DS}=0V$		10	100	nA
Drain Source On-State Resistance	$R_{DS(on)}$	$I_D=5A$ $V_{GS}=10V$		0,35	0,4	Ω
Forward Transconductance	g_{fs}	$I_D=5A$ $V_{DS}=25V$	2,0	4,5		S
Input Capacitance	C_{iss}	$V_{DS}=25V$		500	750	pF
Output Capacitance	C_{oss}	$V_{GS}=0V$		110	170	pF
Reverse Transfer Capacitance	C_{rss}	$f=1MHz$		50	80	pF
Turn-On-Time $t_{on} (t_{on}=t_{d(on)}+t_r)$	$t_{d(on)}$	$V_{CC}=150V$		10	20	ns
	t_r	$I_D=10A$		30	50	ns
Turn-Off-Time $t_{off} (t_{off}=t_{d(off)}+t_f)$	$t_{d(off)}$	$V_{GS}=10V$		30	50	ns
	t_f	$R_{GS}=10\Omega$		20	30	ns
Avalanche Capability	I_{AV}	$L = 100\mu H$ $T_{ch}=25^\circ C$	10			A
Diode Forward On-Voltage	V_{SD}	$I_F=2I_{DR}$ $V_{GS}=0V$ $T_{ch}=25^\circ C$		1,15	1,8	V
Reverse Recovery Time	t_{rr}	$I_F=I_{DR}$ $V_{GS}=0V$		130		ns
Reverse Recovery Charge	Q_{rr}	$-dI_F/dt=100A/\mu s$ $T_{ch}=25^\circ C$		750		nC

- Thermal Characteristics

Item	Symbol	Test conditions	Min.	Typ.	Max.	Unit
Thermal Resistance	$R_{th(ch-a)}$	channel to air			75,0	$^\circ C/W$
	$R_{th(ch-c)}$	channel to case			3,125	$^\circ C/W$

> Characteristics

Typical Output Characteristics

$I_D = f(V_{DS})$; 80μs pulse test; $T_C = 25^\circ\text{C}$

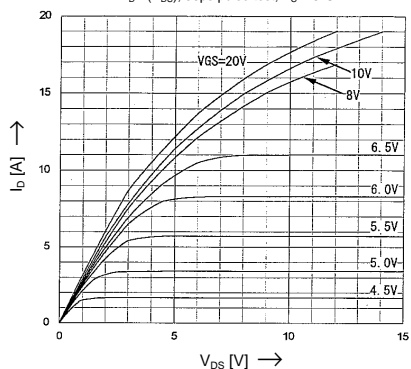

Drain-Source On-State Resistance

$R_{DS(on)} = f(T_{ch})$; $I_D = 5A$; $V_{GS} = 10V$

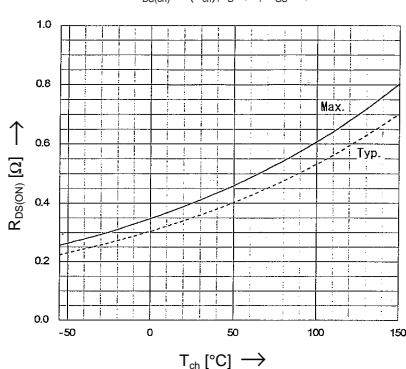

Typical Transfer Characteristics

$I_D = f(V_{GS})$; 80μs pulse test; $V_{DS} = 25V$; $T_C = 25^\circ\text{C}$

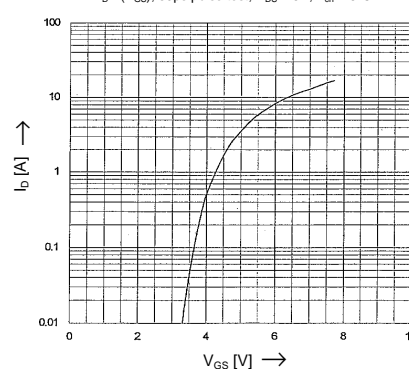

Typical Drain-Source On-State-Resistance

$R_{DS(on)} = f(I_D)$; 80μs pulse test; $T_C = 25^\circ\text{C}$

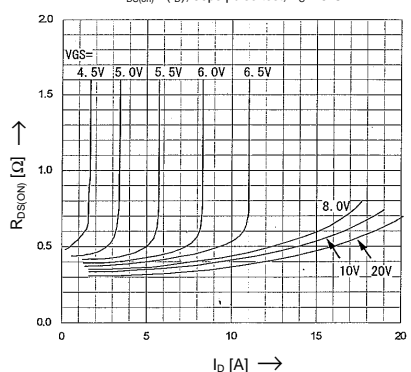

Typical Transconductance

$g_m = f(I_D)$; 80μs pulse test; $V_{DS} = 25V$; $T_C = 25^\circ\text{C}$

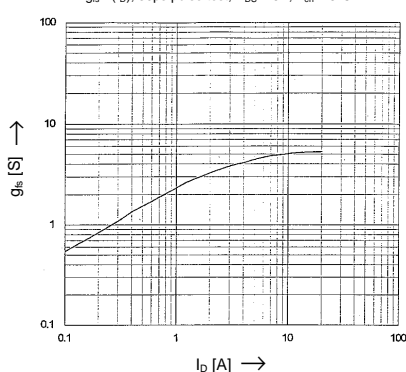

Gate Threshold Voltage

$V_{GS(th)} = f(T_{ch})$; $I_D = 1mA$; $V_{DS} = V_{GS}$

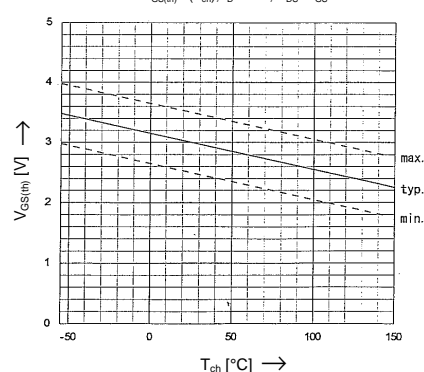

Typical Capacitances

$C = f(V_{DS})$; $V_{GS} = 0V$; $f = 1MHz$

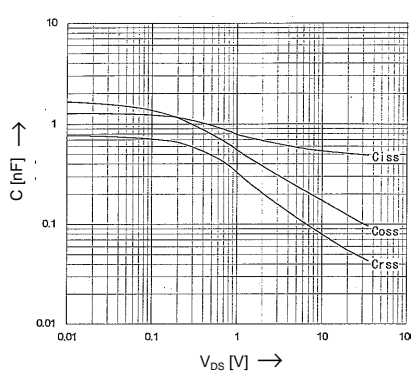

Typical Gate Charge Characteristics

$V_{GS} = f(Q_g)$; $I_D = 10A$

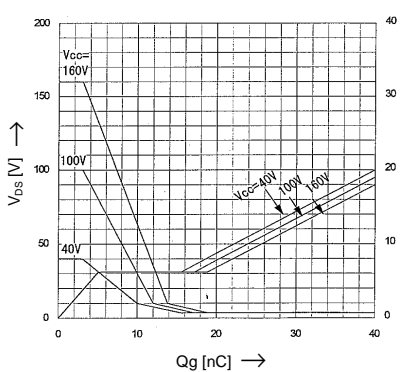

Forward Characteristics of Reverse Diode

$I_F = f(V_{SD})$; 80μs pulse test $T_{ch} = 25^\circ\text{C}$; $V_{GS} = 0V$

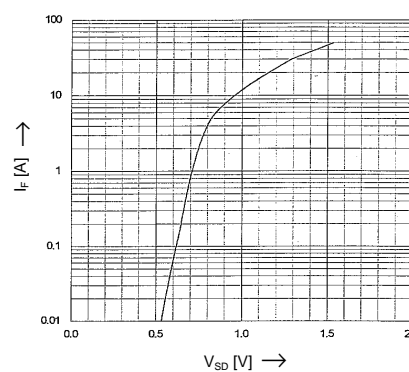

Power Dissipation

$P_D = f(T_C)$

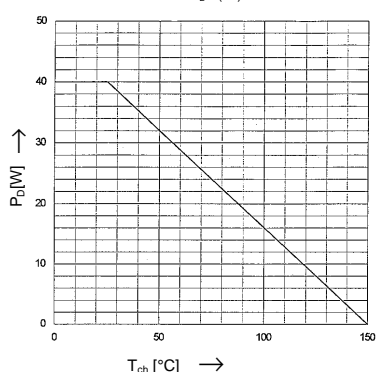

Safe Operation Area

$I_D = f(V_{DS})$; $D = 0.01$; $T_C = 25^\circ\text{C}$

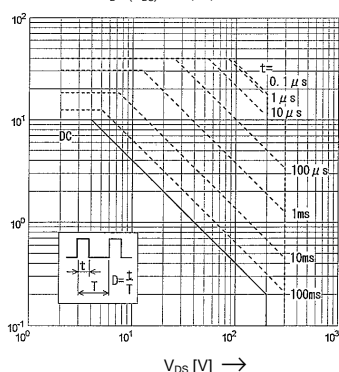

Transient Thermal impedance

$Z_{th(j-c)} = f(t)$ parameter: $D = t/T$

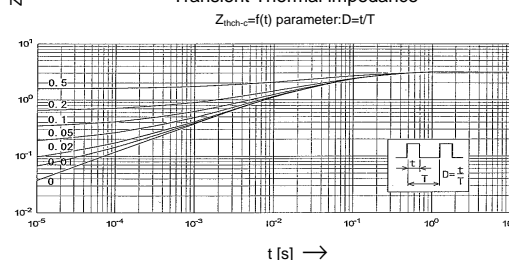

This datasheet has been downloaded from:

www.EEworld.com.cn

Free Download

Daily Updated Database

100% Free Datasheet Search Site

100% Free IC Replacement Search Site

Convenient Electronic Dictionary

Fast Search System

www.EEworld.com.cn