

> **Features**

- High Current
- Low On-Resistance
- No Secondary Breakdown
- Low Driving Power
- High Forward Transconductance

> **Applications**

- Motor Control
- General Purpose Power Amplifier
- DC-DC converters

> **Outline Drawing**

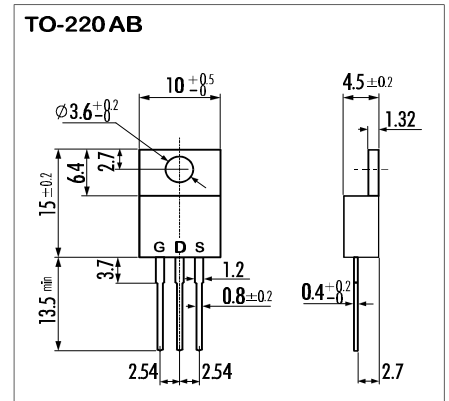

> **Maximum Ratings and Characteristics**

- Absolute Maximum Ratings (T<sub>C</sub>=25°C), unless otherwise specified

Item	Symbol	Rating	Unit
Drain-Source-Voltage	V <sub>DS</sub>	60	V
Drain-Gate-Voltage (R <sub>GS</sub> =20KΩ)	V <sub>DGR</sub>	60	V
Continous Drain Current	I <sub>D</sub>	45	A
Pulsed Drain Current	I <sub>D(puls)</sub>	200	A
Gate-Source-Voltage	V <sub>GS</sub>	±30	V
Max. Power Dissipation	P <sub>D</sub>	80	W
Operating and Storage Temperature Range	T <sub>ch</sub>	150	°C
	T <sub>stg</sub>	-55 ~ +150	°C

> **Equivalent Circuit**

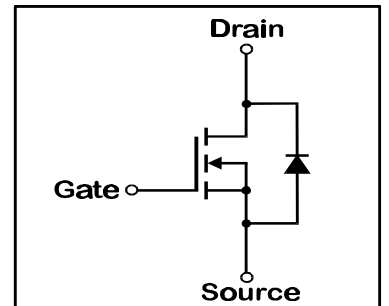

- Electrical Characteristics (T<sub>C</sub>=25°C), unless otherwise specified

Item	Symbol	Test conditions	Min.	Typ.	Max.	Unit
Drain-Source Breakdown-Voltage	V <sub>(BR)DSS</sub>	I <sub>D</sub> =1mA V <sub>GS</sub> =0V	60			V
Gate Threshold Voltage	V <sub>GS(th)</sub>	I <sub>D</sub> =10mA V <sub>DS</sub> =V <sub>GS</sub>	2,5	3,0	3,5	V
Zero Gate Voltage Drain Current	I <sub>DSS</sub>	V <sub>DS</sub> =60V T <sub>ch</sub> =25°C		10	500	μA
		V <sub>GS</sub> =0V T <sub>ch</sub> =125°C		0,2	1,0	mA
Gate Source Leakage Current	I <sub>GSS</sub>	V <sub>GS</sub> =±30V V <sub>DS</sub> =0V		10	100	nA
Drain Source On-State Resistance	R <sub>DS(on)</sub>	I <sub>D</sub> =25A V <sub>GS</sub> =10V		0,017	0,025	Ω
Forward Transconductance	g <sub>fs</sub>	I <sub>D</sub> =25A V <sub>DS</sub> =25V	11	22		S
Input Capacitance	C <sub>iss</sub>	V <sub>DS</sub> =25V		2000	3000	pF
Output Capacitance	C <sub>oss</sub>	V <sub>GS</sub> =0V		800	1200	pF
Reverse Transfer Capacitance	C <sub>rss</sub>	f=1MHz		300	450	pF
Turn-On-Time t <sub>on</sub> (t <sub>on</sub> =t <sub>d(on)</sub> +t <sub>r</sub> )	t <sub>d(on)</sub>	V <sub>CC</sub> =30V		25	40	ns
	t <sub>r</sub>	I <sub>D</sub> =45A		150	230	ns
Turn-Off-Time t <sub>off</sub> (t <sub>off</sub> =t <sub>d(off)</sub> +t <sub>f</sub> )	t <sub>d(off)</sub>	V <sub>GS</sub> =10V		140	210	ns
	t <sub>f</sub>	R <sub>GS</sub> =25 Ω		125	190	ns
Avalanche capability	I <sub>AV</sub>	L=100μH T <sub>ch</sub> =25°C	45			A
Diode Forward On-Voltage	V <sub>SD</sub>	I <sub>F</sub> =2I <sub>DR</sub> V <sub>GS</sub> =0V T <sub>ch</sub> =25°C		1,30	1,95	V
Reverse Recovery Time	t <sub>rr</sub>	I <sub>F</sub> =I <sub>DR</sub> V <sub>GS</sub> =0V		60		ns
Reverse Recovery Charge	Q <sub>rr</sub>	-dI <sub>F</sub> /dt=100A/μs T <sub>ch</sub> =25°C		0,1		μC

- Thermal Characteristics

Item	Symbol	Test conditions	Min.	Typ.	Max.	Unit
Thermal Resistance	R <sub>th(ch-a)</sub>	channel to air			75	°C/W
	R <sub>th(ch-c)</sub>	channel to case			1,56	°C/W

### > Characteristics

Typical Output Characteristics

$I_D = f(V_{DS})$ ; 80μs pulse test;  $T_C = 25^\circ\text{C}$

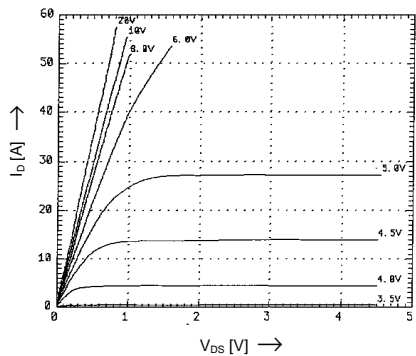

Drain-Source On-State Resistance

$R_{DS(on)} = f(T_{ch})$ ;  $I_D = 25\text{A}$ ;  $V_{GS} = 10\text{V}$

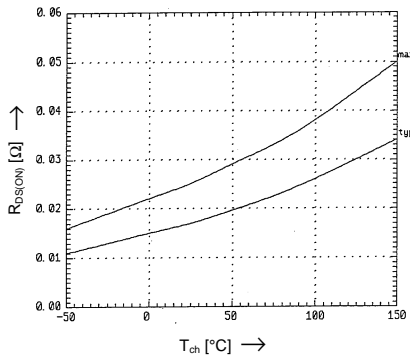

Typical Transfer Characteristics

$I_D = f(V_{GS})$ ; 80μs pulse test;  $V_{DS} = 25\text{V}$ ;  $T_{ch} = 25^\circ\text{C}$

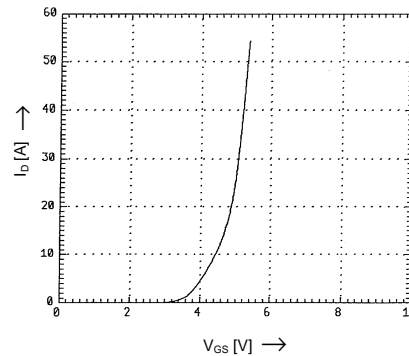

Typical Drain-Source On-State-Resistance

$R_{DS(on)} = f(I_D)$ ; 80μs pulse test;  $T_C = 25^\circ\text{C}$

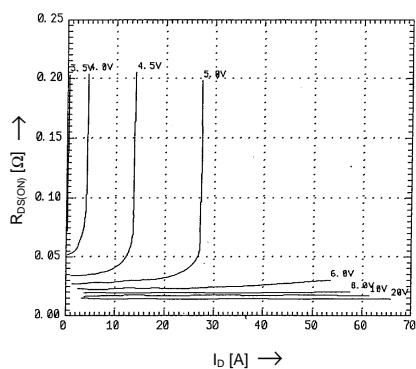

Typical Transconductance

$g_m = f(I_D)$ ; 80μs pulse test;  $V_{DS} = 25\text{V}$ ;  $T_{ch} = 25^\circ\text{C}$

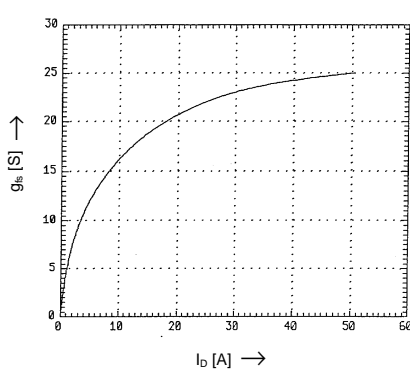

Gate Threshold Voltage

$V_{GS(th)} = f(T_{ch})$ ;  $I_D = 10\text{mA}$ ;  $V_{DS} = V_{GS}$

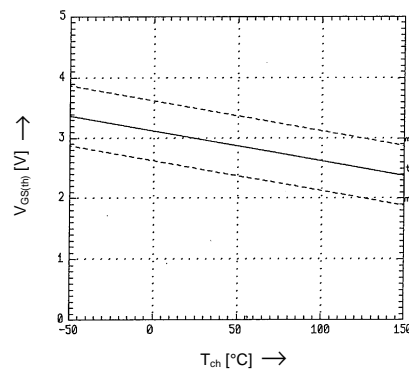

Typical Capacitances

$C = f(V_{DS})$ ;  $V_{GS} = 0\text{V}$ ;  $f = 1\text{MHz}$

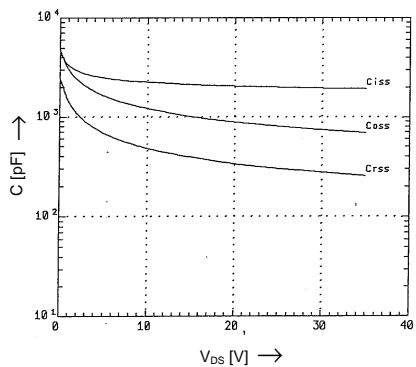

Typical Gate Charge Characteristics

$V_{GS} = f(Q_g)$ ;  $I_D = 45\text{A}$

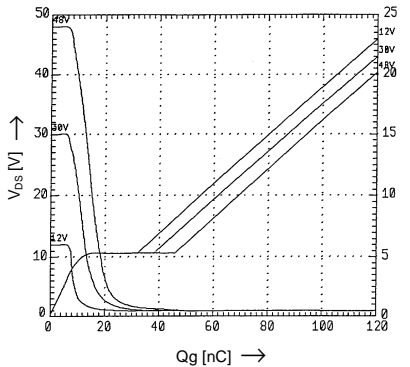

Forward Characteristics of Reverse Diode

$I_F = f(V_{SD})$ ; 80μs pulse test;  $V_{GS} = 0\text{V}$

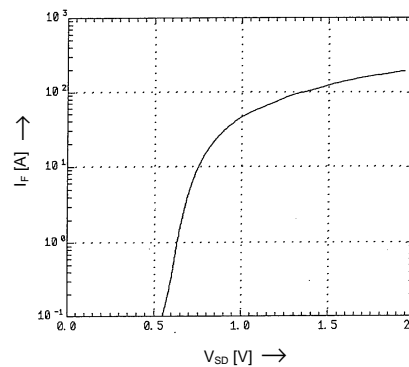

Power Dissipation

$P_D = f(T_C)$

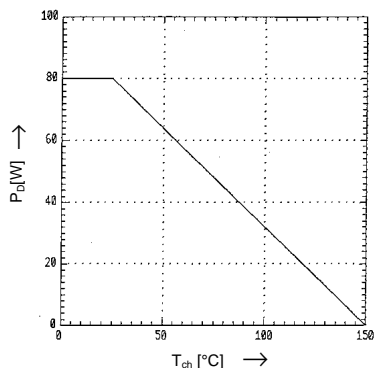

Safe Operation Area

$I_D = f(V_{DS})$ ;  $D = 0,01$ ;  $T_C = 25^\circ\text{C}$

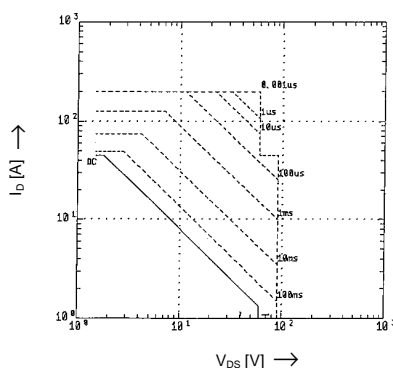

$Z_{th(ch-c)} [K/W]$

Transient Thermal impedance

$Z_{th(ch-c)} = f(t)$  parameter:  $D = t/T$

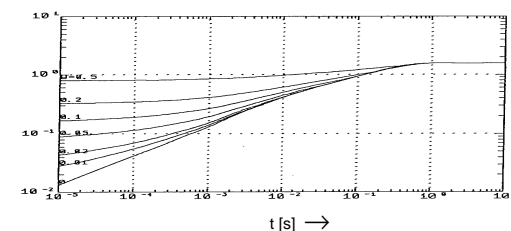

**This datasheet has been downloaded from:**

**[www.EEworld.com.cn](http://www.EEworld.com.cn)**

**Free Download**

**Daily Updated Database**

**100% Free Datasheet Search Site**

**100% Free IC Replacement Search Site**

**Convenient Electronic Dictionary**

**Fast Search System**

**[www.EEworld.com.cn](http://www.EEworld.com.cn)**