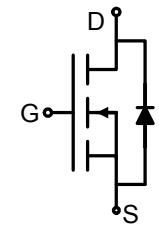
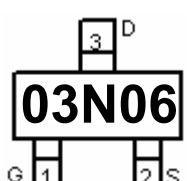
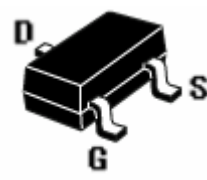

<p><b>Description</b></p> <p>The 03N06 uses advanced trench technology to provide excellent <math>R_{DS(ON)}</math>, low gate charge and operation with gate voltages as low as 2.5V. This device is suitable for use as a Battery protection or in other switching application.</p> <p><b>General Features</b></p> <ul style="list-style-type: none"> <li>● <math>V_{DS} = 60V, I_D = 3A</math>  <math>R_{DS(ON)} &lt; 105m\Omega @ V_{GS} = 10V</math>  <math>R_{DS(ON)} &lt; 125m\Omega @ V_{GS} = 4.5V</math></li> <li>● High power and current handling capability</li> <li>● Lead free product is acquired</li> <li>● Surface mount package</li> </ul> <p><b>Application</b></p> <ul style="list-style-type: none"> <li>● Battery switch</li> <li>● DC/DC converter</li> </ul>	 <p><b>Schematic Diagram</b></p>  <p><b>Marking and Pin Assignment</b></p>  <p><b>SOT-23 -3L Top View</b></p>
--	---

**Absolute Maximum Ratings (TA=25°C unless otherwise noted)**

Parameter	Symbol	Limit	Unit
Drain-Source Voltage	$V_{DS}$	60	V
Gate-Source Voltage	$V_{GS}$	$\pm 20$	V
Drain Current-Continuous	$I_D$	3	A
Drain Current-Pulsed (Note 1)	$I_{DM}$	10	A
Maximum Power Dissipation	$P_D$	1.7	W
Operating Junction and Storage Temperature Range	$T_J, T_{STG}$	-55 To 150	°C

**Thermal Characteristic**

Thermal Resistance, Junction-to-Ambient (Note 2)	$R_{\theta JA}$	73.5	°C/W
--	-----------------	------	------

**Electrical Characteristics (TA=25°C unless otherwise noted)**

Parameter	Symbol	Condition	Min	Typ	Max	Unit
<b>Off Characteristics</b>						
Drain-Source Breakdown Voltage	$BV_{DSS}$	$V_{GS} = 0V, I_D = 250\mu A$	60	65	-	V
Zero Gate Voltage Drain Current	$I_{DSS}$	$V_{DS} = 60V, V_{GS} = 0V$	-	-	1	$\mu A$

Gate-Body Leakage Current	$I_{GSS}$	$V_{GS}=\pm 20V, V_{DS}=0V$	-	-	$\pm 100$	nA
<b>On Characteristics (Note 3)</b>						
Gate Threshold Voltage	$V_{GS(th)}$	$V_{DS}=V_{GS}, I_D=250\mu A$	0.8	1.1	1.4	V
Drain-Source On-State Resistance	$R_{DS(ON)}$	$V_{GS}=10V, I_D=3A$	-	-	105	m $\Omega$
		$V_{GS}=4.5V, I_D=3A$	-	-	125	m $\Omega$
Forward Transconductance	$g_{FS}$	$V_{DS}=15V, I_D=2A$	3	-	-	S
<b>Dynamic Characteristics (Note4)</b>						
Input Capacitance	$C_{ISS}$	$V_{DS}=30V, V_{GS}=0V,$ $F=1.0MHz$	-	247	-	PF
Output Capacitance	$C_{OSS}$		-	34	-	PF
Reverse Transfer Capacitance	$C_{RSS}$		-	19.5	-	PF
<b>Switching Characteristics (Note 4)</b>						
Turn-on Delay Time	$t_{d(on)}$	$V_{DD}=30V, I_D=1.5A$ $V_{GS}=10V, R_{GEN}=1\Omega$	-	6	-	nS
Turn-on Rise Time	$t_r$		-	15	-	nS
Turn-Off Delay Time	$t_{d(off)}$		-	15	-	nS
Turn-Off Fall Time	$t_f$		-	10	-	nS
Total Gate Charge	$Q_g$	$V_{DS}=30V, I_D=3A,$ $V_{GS}=4.5V$	-	6	-	nC
Gate-Source Charge	$Q_{gs}$		-	1	-	nC
Gate-Drain Charge	$Q_{gd}$		-	1.3	-	nC
<b>Drain-Source Diode Characteristics</b>						
Diode Forward Voltage (Note 3)	$V_{SD}$	$V_{GS}=0V, I_S=3A$	-	-	1.2	V
Diode Forward Current (Note 2)	$I_S$		-	-	3	A

**Notes:**

1. Repetitive Rating: Pulse width limited by maximum junction temperature.
2. Surface Mounted on FR4 Board,  $t \leq 10$  sec.
3. Pulse Test: Pulse Width  $\leq 300\mu s$ , Duty Cycle  $\leq 2\%$ .
4. Guaranteed by design, not subject to production

Typical Electrical And Thermal Characteristics

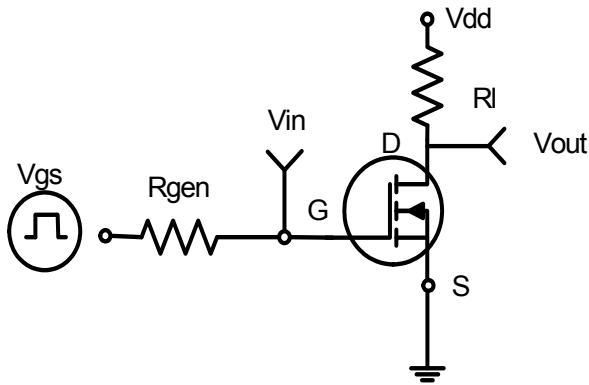

Figure 1: Switching Test Circuit

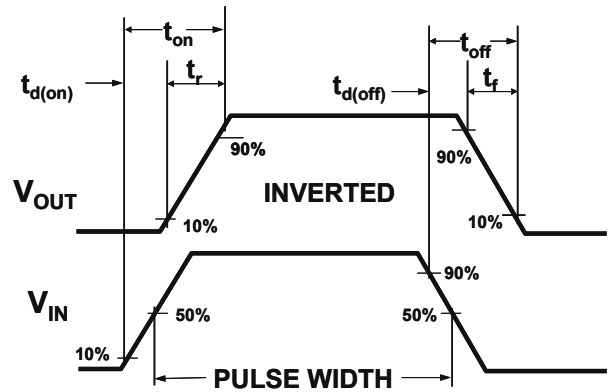

Figure 2: Switching Waveforms

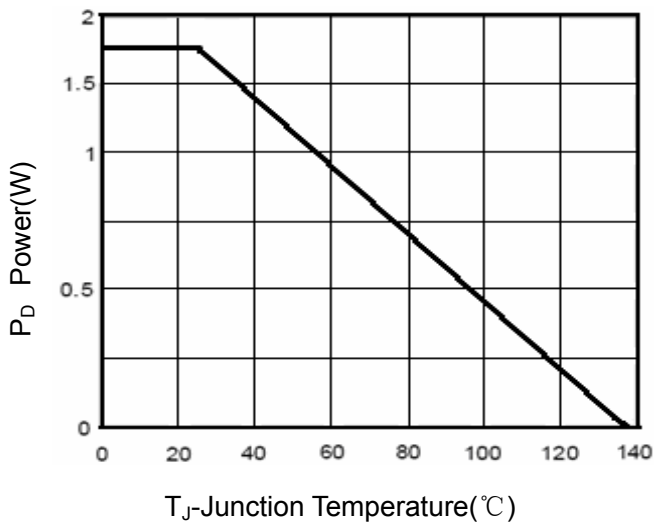

Figure 3 Power Dissipation

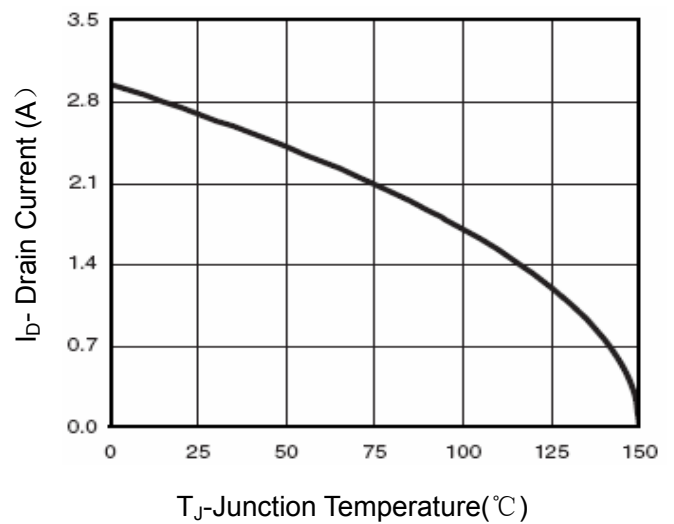

Figure 4 Drain Current

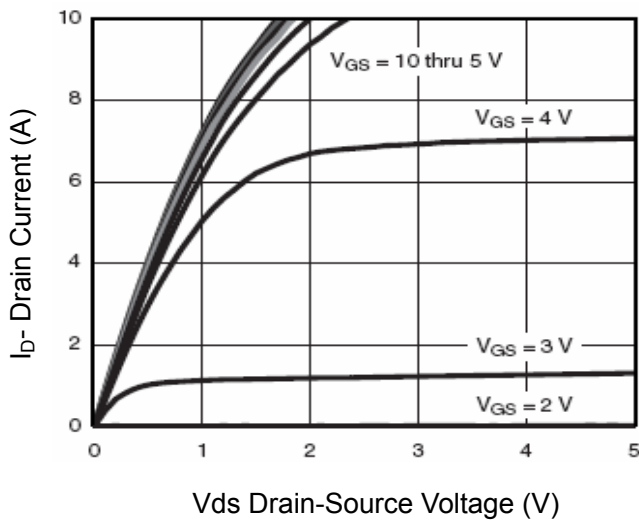

Figure 5 Output Characteristics

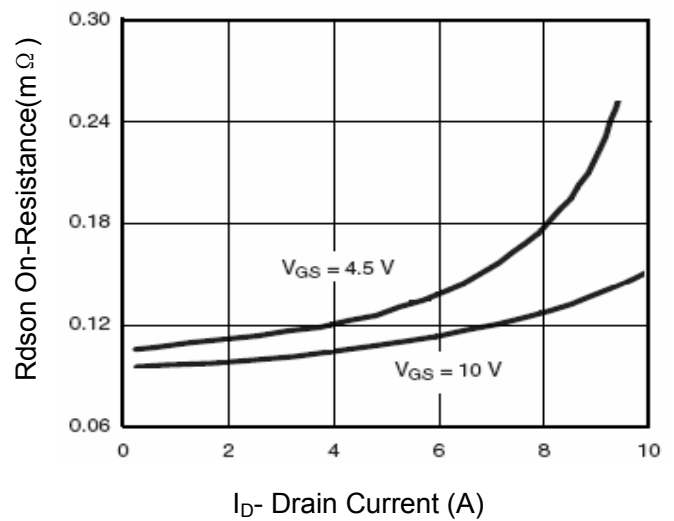
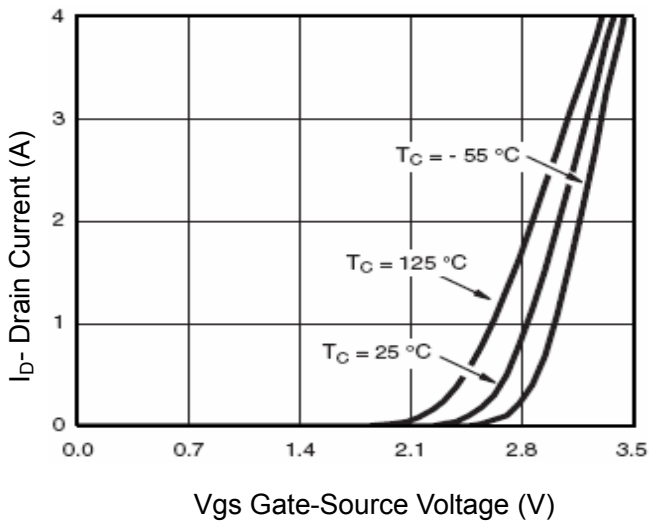
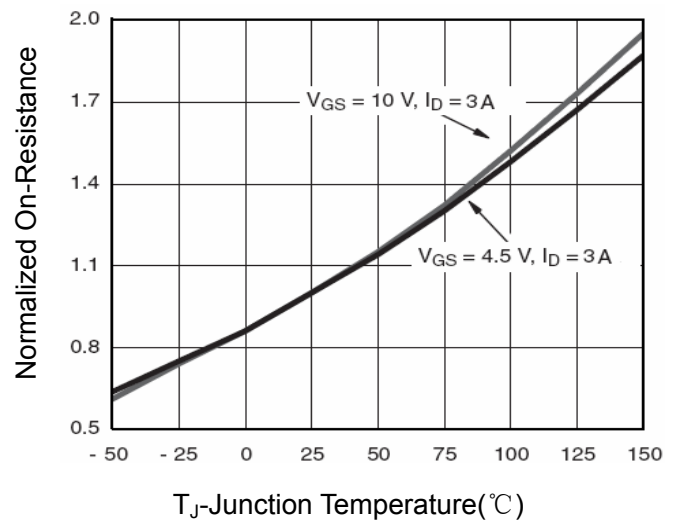

Figure 6 Drain-Source On-Resistance



Vgs Gate-Source Voltage (V)  
**Figure 7 Transfer Characteristics**



$T_J$ -Junction Temperature( $^\circ\text{C}$ )  
**Figure 8 Drain-Source On-Resistance**

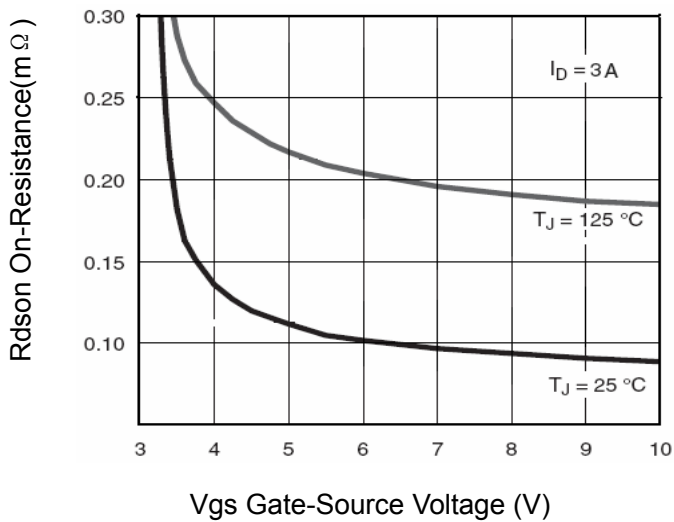

Vgs Gate-Source Voltage (V)  
**Figure 9 Rdson vs Vgs**

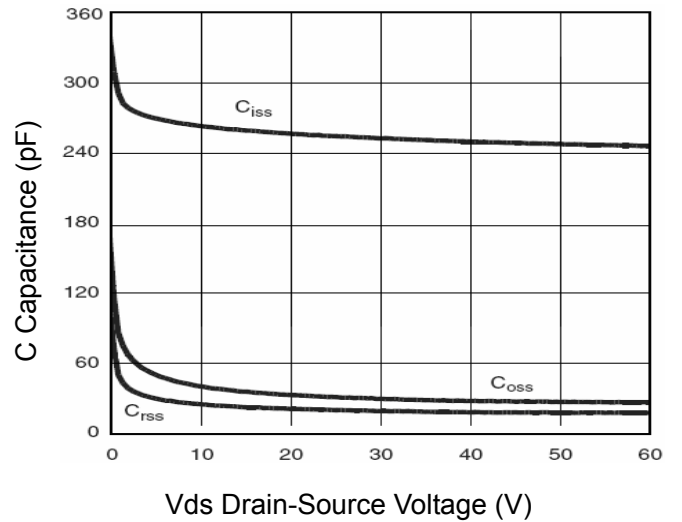

Vds Drain-Source Voltage (V)  
**Figure 10 Capacitance vs Vds**

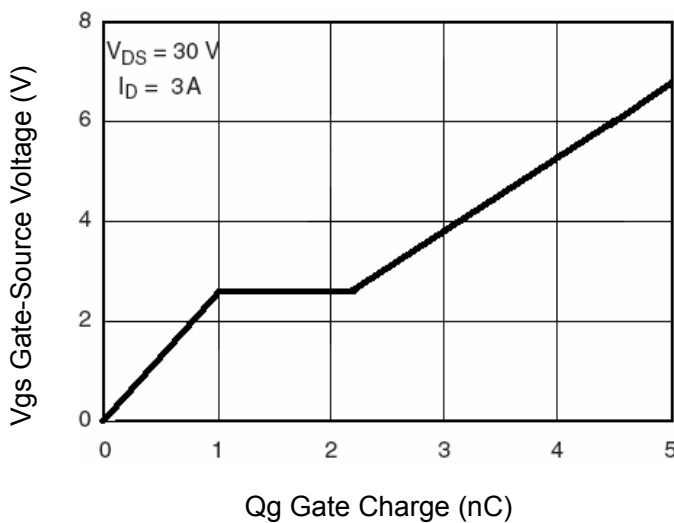

Qg Gate Charge (nC)  
**Figure 11 Gate Charge**

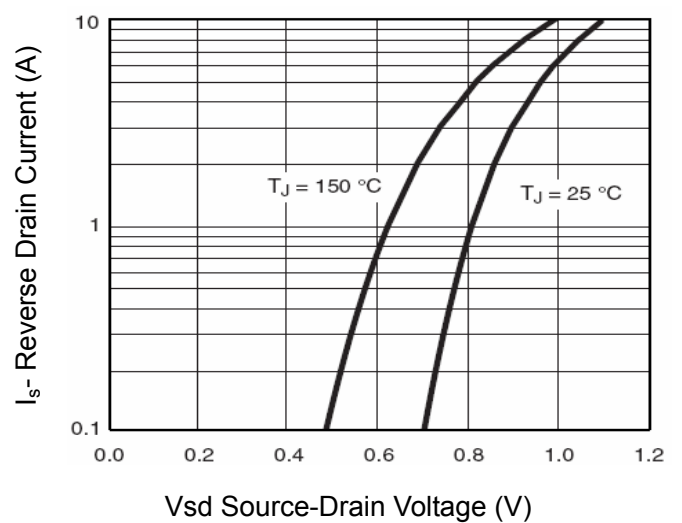

Vsd Source-Drain Voltage (V)  
**Figure 12 Source- Drain Diode Forward**

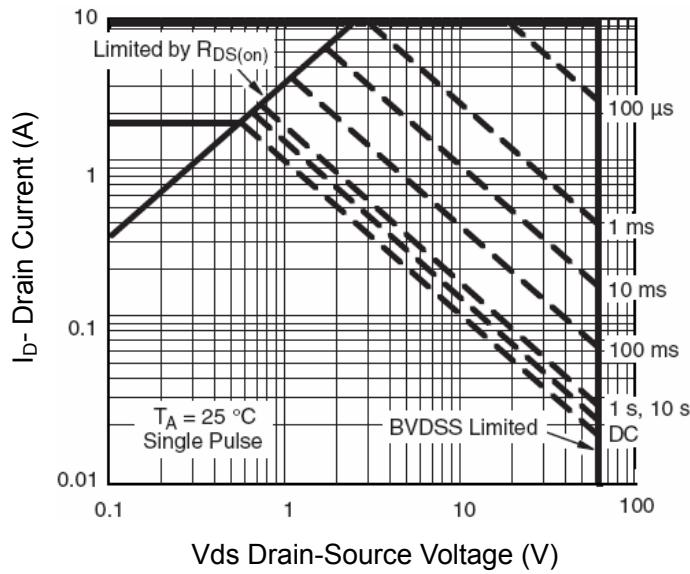

Figure 13 Safe Operation Area

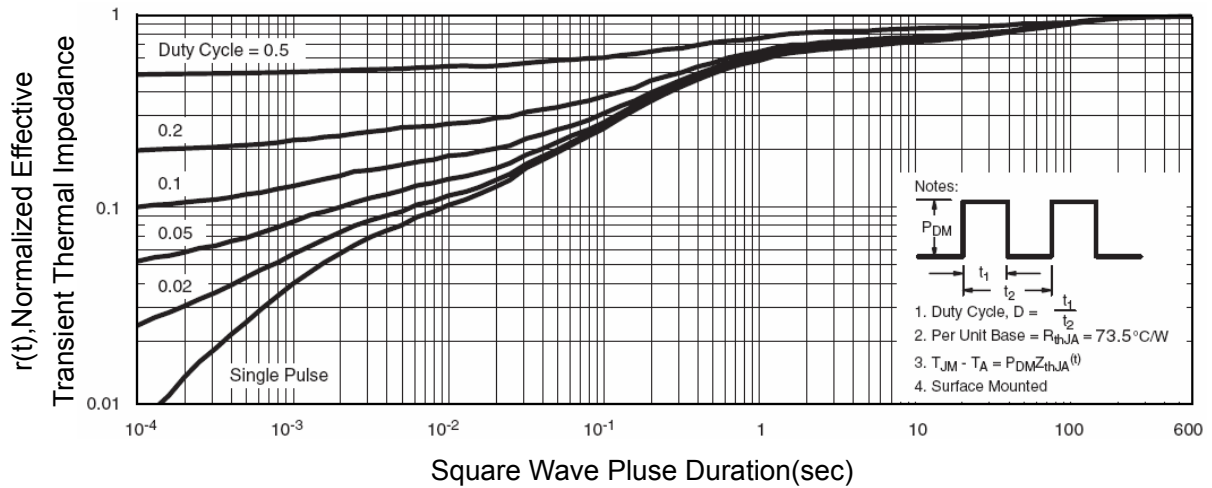

Figure 14 Normalized Maximum Transient Thermal Impedance